

Historic, archived document

Do not assume content reflects current scientific knowledge, policies, or practices.

L...
FEB 7 1936
Agriculture.

**SEEDS
BULBS
and
PLANTS**

**AGRICULTURAL
IMPLEMENTS**

for
1936



*Superb
California
Giants
Petunias*

(See page 29)

THOMAS J. GREY COMPANY
The Seedsman

16 South Market St., BOSTON, MASSACHUSETTS

Novelties and Specialties in Flower Seeds for 1936

Our gardening friends are more or less interested in something new in the floral world, and for this reason we keep in touch with all the world-wide introductions and new specialties that appear from year to year. The novelties and specialties offered on pages 2, 3, 4, and inside cover have been selected by us as being good claim to merit, and worthy of a trial.

Flower Seeds are Proclaimed
by Users Everywhere.
Antirrhinum Rust-Proof
(Maximum Type)

The advent of the Rust-Proof Antirrhinum is destined to make them the most popular flower in America.

	Pkt.
260 Alaska. Glistening white	\$0.35
261 Canary Bird. Soft yellow, deeper yellow lip35
262 Copper shades35
263 Fair Lady. Light pink, white tube35
264 Loveliness. Soft rose35
265 Red Cross. Deep crimson35
266 Maximum Mixed35



Calendula Chrysantha.

Antirrhinum

	Greenhouse	Pkt.
Afterglow	New York Golden	\$1.50
Bertha	Yellow	1.50
Ceylon	Deep ve	1.50
Chester	Rise.	1.00
D	Pink	1.00
Cin	Amer	1.00
Clare	Red	1.00
Lucky	Salmon	1.00
Mr	Salmon	1.00

465A.
4 in

518. New selection of flowers with flowers of red and orange. Pkt. 1.00

Novelties and Specialties in Flower Seeds for 1936

Asters

- 692 **EL MONTE.** New Super Giant. Flowers deep glowing crimson, large and fluffy, borne on heavy, non-lateral, basal-branched stems. Early blooming. Pkt., 25c.
- 810 **BLUE FLAME.** Bright navy blue flowers. Plant of the Comet type, 2½ ft. high and wilt-resistant. ¼ oz., 75c; pkt., 25c.
- 815 **CACTUS ELF.** Delicate flesh pink, cactus flowered, plant 12 in. high. ¼ oz., 85c; pkt., 25c.
- 820 **EDELWEISS.** Very dwarf and compact with semi-double snow white flowers. ¼ oz., 75c; pkt., 25c.
- 825 **GOLDEN SHEAF.** Wilt-resistant, 2 ft. Aurora type of Aster with fully double deep yellow flowers with crest-like center, of good substance and fine depth of petal. ¼ oz., 85c; pkt., 25c.
- 830 **IMBRICATED POMPON MIXED.** Plants of upright habit, 14-16 in. high with small round pompon flowers. Very early. ¼ oz., 75c; pkt., 15c.
- 835 **MASSAGNO WHITE (Tokio).** Pure white flowers with narrow, partly quilled petals. ¼ oz., 85c; pkt., 25c.
- RECORD.** Large flowering ray type, 2 ft., fine for cut flowers. Pkt.
- | | | | |
|------------------------------|--------|------------------------|--------|
| 840 Bright Rose | \$0.15 | 845 Lilac | \$0.15 |
| 850 Violet | .15 | 855 White | .15 |
- UNICUM.** 2 ft. long, narrow curled petals. Pkt.
- | | |
|-----------------------------|--------|
| 870 Deep Lilac | \$0.15 |
| 875 Light Blue | .15 |
| 880 Rose | .15 |
| 885 White | .15 |

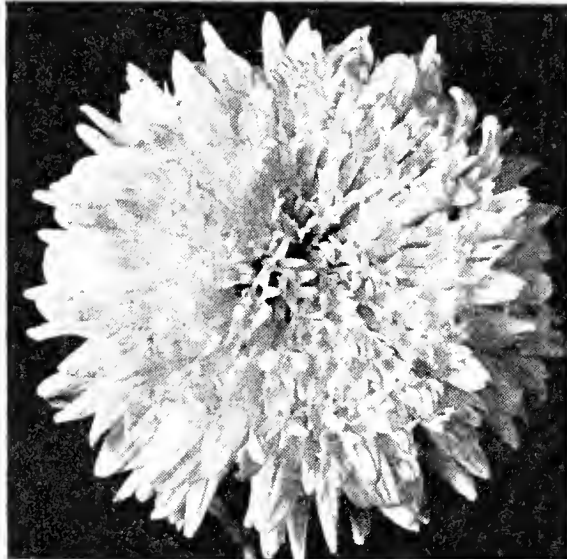

Aster—Golden Sheaf.

Begonia

- 1178 **"TAUSENDSCHOEN" GRACILIS COMPACTA.** Grows about 5 inches high and makes a plant of regular compact growth. The flowers are of rich rose in a profusion of bloom. Equally good for bedding or conservatory use. Pkt., 75c.

Calceolaria

- HYBRIDA MULTIFLORA NANA.** Plants 10-12 inches in height, producing masses of little ball-shaped flowers.
- 1296 **DEEP CRIMSON.** Dark velvety shade; effective contrast to Golden Tiger. Pkt., 75c.
- 1297 **GOLDEN TIGER.** Profuse golden yellow flowers with dark brownish red dots. Pkt., 75c.
- 1298 **SPLENDID MIXED.** Pkt., 75c.

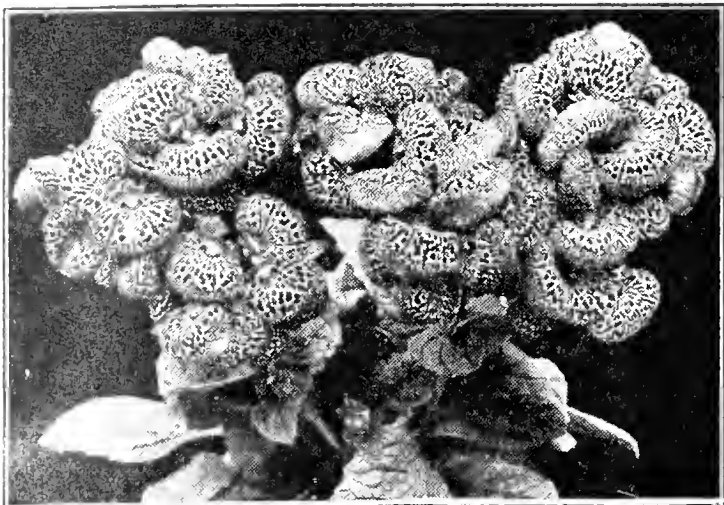

Calceolaria, Golden Tiger.



Canterbury Bells.

Canterbury Bells

- ANNUAL VARIETIES.** Plant grows from 2 to 2½ feet high, each plant having from 6 to 8 spikes of blooms. Seeds planted in February bloom in July.
- 1436 **Angelus Bell.** Deep rose. Pkt., 15c.
- 1437 **Liberty Bell.** Violet-blue. Pkt., 15c.
- 1438 **Wedding Bell.** Pure white. Pkt., 25c.
- 1439 **Mixed.** Pkt., 15c.
- 1512 **DWARF BEDDING MIXED.** New type about 20 inches in height, forming bushes over 3 ft. in circumference, often bearing 100-150 flowers. Mixed colors only, containing various shades of blue, mauve and white. Biennial. Pkt., 25c.

Cyclamen - Binneweis

- 2139 **MOZART.** New deep pink. Pkt., \$1.00.
- 2170 **NEW RUFFLED GIANTS, MIXED.** Pkt., \$1.00.

Dahlia

- 2220 **UNWIN DWARF GIANT FLOWERED, MIXED.** The flowers are semi-double on long, strong stems, and are borne in profusion on bushy plants. Pkt., 25c.



Nasturtium, Golden Gleam.

Petunia

- 6301 **CELESTIAL ROSE.** New Hybrid Nana Erecta. Deep rose; very compact. $\frac{1}{4}$ oz. \$1.00, pkt. 20c.
- 6304 **MARTHA WASHINGTON.** A ruffled or frilled Nana Compacta. Its growth is about 9 inches high and it forms a perfect ball effect, literally smothered with lovely frilled blooms about 3 inches in diameter. The frilled portion of the flower is a beautiful blush pink and the center portion is strongly veined a rich wine-red deepening in the throat to dark violet; the whole forming a striking contrast of colors. Pkt. 35c.
- 6306 **NEW MINIATURE ROSE GEM.** Rose Gem is a charming addition to the new miniature group of Petunias. It is the rich deep rose that has made Petunia Rose of Heaven so popular. The plant is neat and compact, five to six inches high and covered with rich rose colored blooms about two inches in diameter. Pkt. 35c.
- 6313 **PERIWINKLE, nana compacta.** The delightful pastel blue flowers are large and borne in profusion and true to color, on plants of dwarf, compact growth. Pkt., 25c.
- 6314 **FLAMING VELVET, Hybrid.** Awarded Gold Medal for highest number of points in 1935 All-America Selections. Brilliant velvety scarlet. Outstanding for color, type, and uniformity. Pkt. 50c.
- 6370A **GIANT DOUBLE FRINGED CRIMSON.** Very large; new. Pkt. \$1.00.
- 6371 **GIANT DOUBLE FRINGED HELIOTROPE.** Very large; new. Pkt. \$1.00.
- 6372 **GIANT DOUBLE FRINGED ROSE-PINK AND WHITE.** Bright rose-pink with a large white frill giving the flowers the appearance of huge balls of pink and white lace. 5-6 in. in diameter. Pkt. 50c.
- 6373 **DOUBLE ROSE QUEEN.** Immense fringed flowers 5-6 in. in diameter, coming quite true from seed and very double. Pkt. 50c.
- 6374 **DOUBLE WHITE MADONNA GIANT.** Double fringed, deeply fluted flowers. Pkt. 50c.
- 6428 **PHLOX DRUMMONDI, Gigantea Art Shades.** A new strain of Phlox Drummondii with flowers an inch and a quarter to an inch and a half in diameter. It has a most wonderful range of color in soft Art Shades. The soft colors blended together make a most beautiful mixture. Plants about 9 inches high. Winner of Award of Merit in the 1935 All-America Selections. $\frac{1}{8}$ oz. \$1.00, pkt. 25c.

NOVELTIES and SPECIALTIES

Cosmos

- 2070 **KLONDYKE EARLY ORANGE FLARE.** Vivid orange with light green foliage. In bloom in less than 4 months from sowing. $\frac{1}{4}$ oz. 45c, pkt. 25c.

Delphinium

- 2382 **SUMMER CLOUD.** Best perennial; pure white. Pkt. 35c.

Exacum

- 2738 **AFFINE ATROCOERULEUM.** Fragrant and charming indoor plant producing numerous small dark lavender flowers with golden stamens. Foliage light green. Seedlings sown in Jan.-Feb. flower in June and continue until autumn. Pkt., 50c.

Kalanchoe

- 5178 **GLOBULIFERA COCCINEA.** Excellent winter flowering house plant. Brilliant scarlet Bouvardia-like flowers and small green foliage. Pkt. 50c.

Marigold

- 5440 **DIXIE SUNSHINE.** New Chrysanthemum-flowered type. Brilliant golden yellow flowers on tall, bushy plants. Pkt. 25c.
- 5459 **GUINEA GOLD.** A distinct type, rich color; flowers loosely double; a fine cut flower variety. Pkt. 25c.
- 5474 **YELLOW SUPREME.** Large fluffy blooms of creamy lemon-yellow; free from the Marigold odor. Pkt. 25c.
- 5524 **MEXICAN DWARF ORANGE.** Plants 15 to 18 inches, freely branched, bearing quantities of very large, semi-tubular-petaled flowers of bright orange. Pkt. 15c.



Guinea Gold Marigold.

Nasturtium

- 5808 **DOUBLE DWARF GEM MIXTURE.** Compact form, without runners. Excellent color range of good sized, sweet scented, double flowers. Oz. \$1.50, $\frac{1}{4}$ oz. 40c, pkt. 25c.
- 5811 **DOUBLE GLEAM HYBRIDS.** Collection of gorgeously colored, large, well formed flowers thriving under almost any cultural conditions. Oz. 40c, pkt. 15c.
- 5812 **BODGER'S SWEET-SCENTED GOLDEN GLEAM.** "A double variety from seed." Flowers rich golden yellow. Vines semi-trailing, about 2 ft. Fine for open garden or window boxes. Oz. 30c, pkt. 15c.
- 5814 **DOUBLE SCARLET GLEAM.** Immense blooms of fiery orange-scarlet, fragrant and double, on semi-dwarf plants. Oz. 50c, pkt. 20c.

Pansy

- 6130 **MAPLE LEAF SUPER GIANTS MIXED.** New, compact habit with large, attractive foliage. Bright colored flowers averaging 4 inches across. Pkt. 50c.
- ROGLI or SWISS GIANTS**
- 6162 **ALPENGLOW.** Deep red shades. Pkt. 50c.
- 6238 **SWISS DWARF GIANTS MIXED.** Rich and various shades of mammoth flowers on plants of dwarf habit. Pkt. 50c.
- 6241 **SWISS GOLDEN YELLOW.** Pkt. 50c.
- 6242 **ULLSWATER BLUE (Lake of Thun).** The deepest of all blue Pansies; very large. Pkt. 50c.

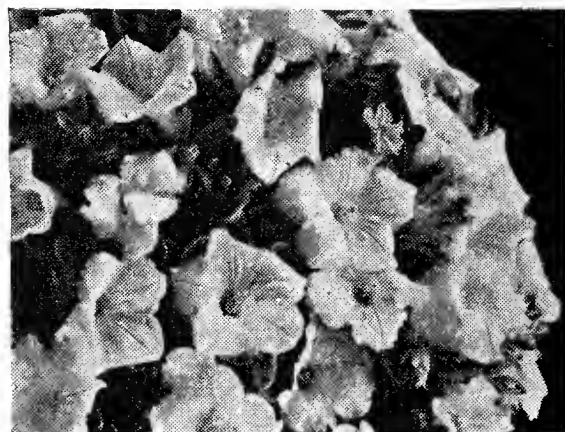

Petunia, Rose Gem.

FLOWER SEED NOVELTIES AND SPECIALTIES—Continued

Primula Chinensis

6820 **DAZZLER.** New. The most vivid of all flowers. The flowers are brilliant orange-red, produced well above the attractive foliage. About 20 blooms open at one time. Pkt. \$1.00.

Salvia

7118 **SALMON-PINK.** Blooms of large size and beautiful salmon-pink color on strong spikes. Blooms from mid-August until killed by hard frosts. Pkt. 35c.

Schizanthus

7208 **CANADIAN SUPER-GIANTS.** Largest flowers of any strain; blooms 2 inches across. Rich colorings and unusual markings. Sow in February under glass for summer use outdoors. Pkt. \$1.00.

7218 **PANSY-FLOWERED.** Danbury Park Strain. Large, smooth edge blooms in great variety of rich self colors. Pkt. 50c.

New Sweet Pea, Early Flowering

7874 **SHIRLEY TEMPLE.** An outstanding variety. Color rich soft pink. Petals frilled and fluted; flowers very large, usually four on each stem. Oz. \$2.00, pkt. 50c.

Verbena

8209 **VIOLET BOUQUET.** A new nana erecta variety which grows about 8 inches high. Color deep violet with a cream eye. Long blooming season. Pkt. 25c.

Viola

8282 **ARKWRIGHT RUBY.** New, fragrant bedding Viola. Color terra cotta markings on crimson. Pkt. 25c.

8290 **LAVENDER GEM** (Cornuta). Color soft deep lavender. Plants of compact habit bearing a continuous profusion of long lasting bloom. Pkt. 50c.

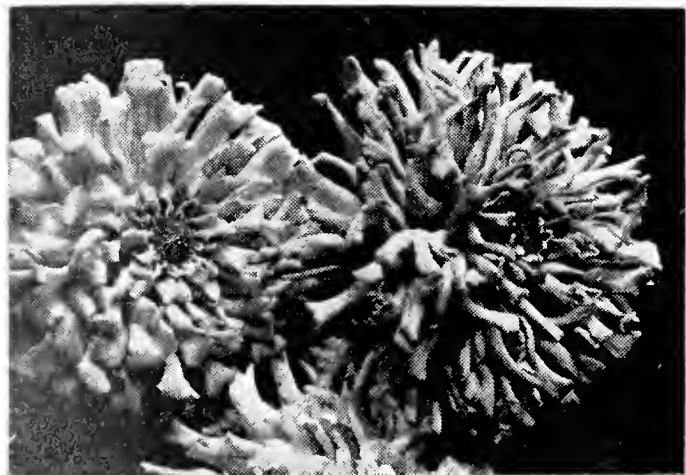

Zinnia, Fantasy Mixed.



Schizanthus.

Zinnia

8446 **DESSERT GOLD** (Crown of Gold type). A variety containing the light and deep hues of gold, each petal overlaid at the base with a deeper golden yellow. 1/8 oz. 65c, pkt. 25c.

8447 **FANTASY MIXED.** A mixture of bright and pastel shades of shaggy petaled, medium sized double flowers. 1/8 oz. 65c, pkt. 25c.

8448 **SCABIOSA-FLOWERED MIXED.** Plants 2 to 2 1/2 ft. Flowers medium sized, resembling the annual Scabiosa. Colors include crimson, scarlet, orange, yellow, pink and white. 1/8 oz. 60c, pkt. 25c.

8498 **EARLY WONDER.** A new race of dwarf flowering Zinnias, growing 12 to 15 inches high. Color fiery salmon-cerise-pink flowers, borne on medium size long stems that start from the ground with no laterals and very few leaves. In the greenhouse it produces flowers in 45 days from seed. 1/8 oz. 40c, pkt. 20c.

8499 **GYPSY.** Same race as Early Wonder. Color deep burnished orange. 1/8 oz. 40c, pkt. 20c.

8504 **LILLIPUT, TOM THUMB MIXED.** Plants are only 4 to 6 inches high, and are covered with well formed flowers of the Lilliput type in all colors. 1/8 oz. 50c, pkt. 20c.

8527 **PUMILA PICOTEE, DELIGHT.** A dwarf double type in shades of salmon, yellow and lavender, flowers not so large and stems more slender than the ordinary type; extra fine for cut flowers. 1/8 oz. 50c, pkt. 20c.

FLOWER SEED NOVELTIES AND SPECIALTIES—Continued

Seeds of Hardy Rock Garden Plants

- 102 **AETHIONEMA** (Persian Candytuft). 9 in. June-July. Sun. Strong, twiggy bushes covered with long, slender spikes of rosy pink flowers. Pkt. 30c.
- 202 **ALYSSUM serpyllifolium** (Alpestre). Very dwarf. 4-5 in. Racemes of pale yellow flowers and rough, hoary leaves. Blooms just after the well known Saxatile variety. Pkt. 20c.
- 203 **ALYSSUM**. Rock Garden Perennial. Rare species mixed. Pkt. 15c.
- 252 **ANEMONE pulsatilla** (Pasque Flower). 10 in. April-May. An interesting plant producing violet or purple flowers. Pkt. 25c.
- 432 **AQUILEGIA alpina**. Dwarf, dark blue. Pkt. 25c.
- 519 **ARENARIA** (Sandwort). *Montana*. 6-8 in. Grows in close tufts of bright green foliage, profusely covered in the spring with small silvery white flowers. Pkt. 25c.
- 1066 **AUBRIETIA Campbelli**. Very large deep blue flowers on plant of creeping habit, 6 in. Excellent for rockeries and edging. Pkt. 35c.
- 1068 **AUBRIETIA Eyri**. A dainty low creeping plant. Fine for crevices of rocks. Rosy lilac, flowers for a long period. Pkt. 30c.
- 1292 **CALANDRINIA umbellata**. 4-5 in. Will do well in a hot location where other plants may not succeed. Bright crimson saucer-shaped flowers. Prostrate habit. Pkt. 20c.
- 1392 **CAMPANULA garganica**. June. A low spreading tuft covered with starry light blue flowers with small white eye. Fine for hanging over a rock. Pkt. 35c.
- 1401 **CAMPANULA barbata**. 1 ft. Called Queen of the Lower Alpine Meadows. Large grayish blue bells on 12-in. stems. Pkt. 25c.
- 1403 **CAMPANULA Raineri**. Erect blue flowers in June and July. Plant dwarf, spreading. Pkt. 25c.
- 1435 **CAMPANULA rotundifolia** (Scotch Bluebells). 1 ft. June to Aug. Clear blue flowers, especially adapted for crevices. Also does well on steep slopes. Pkt. 25c.
- 2510 **DIANTHUS Allwoodi alpinus**. 6 in. June-July. Glossy foliage with large bright rose flowers. Thrives best in loam to which a little lime has been added. Shade a little in hottest part of summer. Pkt. 50c.
- 2658 **ERINUS alpinus roseus**. 4 in. May-June. The foliage grows in rosettes, the flowers in racemes of rosy purple. Fine for pockets or between steps. Pkt. 25c.
- 3026 **GYPSOPHILA repens**. Trailing rose-pink Baby's Breath. $\frac{1}{8}$ oz. 40c, pkt. 15c.
- 5228 **LAVANDULA, Munstead Strain**. 1 ft. Dwarf, compact, early flowering type with deep lavender flowers. Pkt. 25c.
- 5247 **LINUM, alpinum**. Beautiful true blue flax of spreading habit, blooming in May and June. Best rock garden variety. Pkt. 25c.
- 5248 **LINUM flavum nanum compactum**. Glowing yellow new dwarf Flax suitable for borders and rockeries. Pkt. 25c.
- 5388 **LYCHNIS alpina**. 1 ft. A pretty dwarf plant with clusters of brilliant rose colored flowers in spring and early summer. Pkt. 25c.
- 6012 **NEPETA Mussini** (Ground Ivy). 1-1 $\frac{1}{2}$ ft. Fine for any place in the rock garden; compact habit, producing masses of lavender flowers. Pkt. 25c.
- 6014 **NEPETA nervosa** (Catmint). 1 ft. Bright, clear blue. Pkt. 25c.
- 7152 **SAXIFRAGA umbrosa** (London Pride). Sun or shade. Numerous small pink flowers, fine for rocks or edging; foliage makes a solid carpet. Pkt. 30c.
- 7242 **SEDUM spurium coccineum** (Stonecrop). 6 in. July and Aug. Sun. Showy rosy crimson flowers. They thrive in almost any soil. Pkt. 25c.
- 7262 **SILENE Schafta** (Autumn Catchfly). 4 to 6 in. July to Oct. When in flower, they are a mass of bright pink. Pkt. 20c.
- 8162 **TUNICA saxifraga** (Coatflower). 6 in. Beautiful tufted plant with light pink flowers produced all summer. Fine for either border or rockery. Pkt. 20c.
- 8223 **VERONICA incana (candida)**. 1 ft. July-Aug. A white, woolly plant with numerous blue flowers. Makes a fine show even when not in bloom. Pkt. 25c.
- 8228 **VERONICA teucrium**. Royal blue. 1-ft. Valuable for rockeries and dwarf borders. Pkt. 25c.

Other Seeds of Rock Garden Plants to be Found in Catalog

Hardy Varieties: *Alyssum saxatile compactum*, *Achillea*, *Arabis*, *Armeria*, *Asperula*, *Aubrietia*, *Campanula carpatia*, *Cerastium*, *Cheiranthus*, *Dianthus deltoides*, *Edelweiss*, *Geum*, *Helianthemum mutabile*, *Heuchera*, *Iberis* (Perennial Candytuft), *Linum*, *Primula* (hardy varieties), *Sedum*.

Annual Varieties: *Alyssum*, Dwarf; *Antirrhinum*, Tom Thumb varieties; *Candytuft*, dwarf varieties; *Marigold*, dwarf varieties; *Mesembryanthemum*; *Petunia*, dwarf varieties; *Portulaca*; *Silene*; *Viola cornuta*, *Zinnia Lilliput*, and *Gem* varieties.



Aubrietia eyri.



Nepeta mussini.



Tunica saxifraga.

Grey's Superior Flower Seeds

A very carefully revised list to which many meritorious and recently introduced sorts have been added and all inferior varieties discarded.

All flower seeds mailed free on receipt of price quoted.

If the number is used when ordering, it will not be necessary to write the name.



No.		Pkt.	No.		Pkt.
10	ABUTILON, Prize Mixed (Flowering Maple). Perpetual bloomers and rapid growers; seed sown indoors in March will produce plants that will bloom outdoors during the summer and indoors all winter....	\$.25			
	ACACIA. Beautiful half-hardy shrubs, with pretty, ornamental foliage and graceful racemes of yellow flowers. Soak the seeds in warm water before sowing. 6 to 10 ft.				
15	baileyana. Long sprays of bright yellow flowers; excellent for cutting. ¼ oz.	50c .25			
20	floribunda. Deep yellow ¼ oz.	35c .15			
25	lophantha speciosa. Fine yellow, delicate foliage ¼ oz.	35c .15			
30	Finest Mixed Varieties. From a large collection ¼ oz.	35c .15			
	ACANTHUS. Stately ornamental, hardy perennials, remarkable for their beautiful foliage, and curious flowers in Aug. and Sept. 2 to 4 ft.				
35	mollis. The beautiful foliage of this sort is said to have given rise to the Corinthian style of architecture; flowers white. ¼ oz.	35c .15			
40	mollis latifolius. Handsome sort; more robust than the preceding ¼ oz.	35c .15			
45	ACHILLEA, The Pearl. One of the best hardy perennials, covered with heads of pure white, double flowers from spring till frost; fine for cutting; 1½ ft. 1/16 oz.	\$1.50 .25			
50	ACHIMENES, Superb Mixed. Profuse blooming greenhouse plants, 1 ft. high, easily grown and flowering through the summer. The flowers vary in size and are of the richest colors50			
	ACONITUM (Monkshood). Hardy perennials, with long spikes of hood-shaped flowers, excellent for shrubby borders and shady places. June to Sept.				
52	lycoctonum. Pale yellow. 3 ft.20			
55	napellus. Large deep blue. 3 ft. ¼ oz.	\$1.25 .15			
60	napellus roseum. Pink25			
68	wilsoni. Large trusses, light blue. 4 ft.25			
70	Finest Mixed ¼ oz.	60c .10			
	ACROCLINIUM. One of the prettiest and best annual everlasting for cutting fresh or for Winter use. For drying they should be cut before fully open and hung in an airy room to dry, heads down. 15 in.				
75	Double Rose ¼ oz.	35c \$0.10			
80	Double White ¼ oz.	35c .10			
84	Double New Giant Hybrids ¼ oz.	75c .15			
90	ADLUMIA cirrhosa (Mountain Fringe, or Allegheny Vine). Beautiful climber, Maidenhair fern-like foliage, pink flowers, a self-sowing, hardy biennial. 15 ft. 1-16 oz.	75c .15			
	ADONIS. Free-flowering border plants, with showy flowers of easy culture in any garden soil.				
95	aestivalls (Flos Adonis). Deep crimson, free flowering annual. 1 ft. July and Aug. ¼ oz.	25c .10			
100	vernalis. Large, yellow flowers in May and June. Hardy perennial. 1 ft. ¼ oz.	\$1.00 .10			
105	AGATHEA coelestis (Blue Marguerite). Free blooming, tender perennial with blue daisy-like flowers. Fine for winter flowering and a good bedder. 1½ ft.25			
	AGERATUM. Effective plants for bedding, covered with bloom throughout the season. Valuable for cutting. Half-hardy annual.				
106	Blue Ball. 4 in., deep blue.25			
108	Blue Cap. Large, deep blue flowers, small foliage: 5 in.25			
110	Blue Perfection. Deep blue. ¼ oz.	60c .15			
115	Blue Star. Bright light blue; 5 in. ½ oz.	75c .25			
120	Imperial Dwarf. Dark blue; 8 in. ¼ oz.	75c .15			
125	Imperial Dwarf. White; 8 in. ¼ oz.	85c .15			
135	Little Dorrit. Azure blue; 8 in. ½ oz.	50c .10			
140	mexicanum. Large, lilac-blue; 1½ ft. ¼ oz.	50c .15			
145	mexicanum album grandiflorum. Large white; 1½ ft. ¼ oz.	50c .15			
150	Princess Victoria Louise. Bright blue, white center; 8 in. ¼ oz.	75c .15			
152	Venus. Dwarf pink, 6 in15			

No.		Pkt.
155	AGROSTEMMA coronaria (Mullein Pink). Free flowering, hardy perennial, bright crimson flowers; fine for cutting; 2 ft. $\frac{1}{4}$ oz., 25c	\$0.10
160	hybrida walkeri . Bright rose; hardy.....	.15
165	coelirosa (Rose of Heaven). Fine annual sort, with rose flowers. Fine for cutting; 1 $\frac{1}{2}$ ft. $\frac{1}{4}$ oz. 25	.10
170	ALONSOA, Mixed (Maskflower). Charming annual, flowering throughout the summer and autumn; easily grown and very desirable. 1 $\frac{1}{2}$ ft..... $\frac{1}{2}$ oz. 30c	.15
175	ALSTROEMERIA, Finest Mixed . Handsome, lily-like, half-hardy perennials, varying from pale yellow to orange red; 3 ft. $\frac{1}{4}$ oz. 75c	.25
	ALYSSUM . Dwarf-growing annuals, blooming profusely throughout the season.	
180	benthami (Sweet Alyssum). White, fragrant, free bloomer; 1 ft. 4 ozs. \$1.50, oz. 50c	.10
185	Carpet of Snow (White Fleece). Pure white, very dwarf and sweet; 4 in..... $\frac{1}{4}$ oz. 40c, oz. \$1.25	.15
187	Lilac Queen . Dwarf annual... $\frac{1}{4}$ oz. 50c	.10
190	Little Dorrit . A perfect gem for borders or beds, compact, white and sweet. $\frac{1}{4}$ oz. 40c	.15
195	Little Gem . White, distinct and very sweet. $\frac{1}{2}$ ft. $\frac{1}{4}$ oz. 30c, oz. \$1.00	.10
196	Lutescens . 6 in. Annual; creamy yellow.. $\frac{1}{4}$ oz. 40c	.15
198	Minimum . 3 in. Very dwarf compact white $\frac{1}{4}$ oz. 40c	.15
200	saxatile compactum (Gold Dust). Bright, yellow, spring flowering, hardy perennial; 9 in. $\frac{1}{4}$ oz. 85c, oz. \$3.00	.15
201	saxatile, Silver Queen . Pale yellow $\frac{1}{8}$ oz. 75c	.15
	AMARANTHUS . Brilliant foliaged annuals, with showy racemes of flowers; very ornamental and excellent for borders and sub-tropical gardening.	
205	caudatus (Love-lies-bleeding). Long drooping, scarlet racemes; 3 ft. $\frac{1}{4}$ oz. 25c	.10
212	Molten Fire . Brilliant poinsettia-like tips.	.15
215	salicifolius (Fountain Plant). Long foliage, beautifully variegated; 3 ft. $\frac{1}{4}$ oz. 35c	.10
220	tricolor splendens (Josephs-coat). Foliage crimson, yellow and bronze; 2 ft. $\frac{1}{4}$ oz. 50c	.15



Alyssum, Carpet of Snow.



Anchusa Italica.

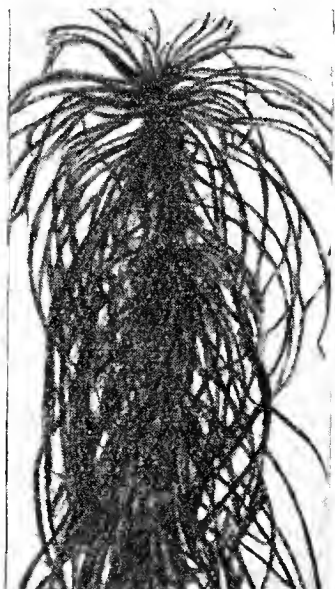

Amaranthus Salicifolius.

No.		Pkt.
225	AMARYLLIS, Special Hybrids (Hippeastrum). Saved from extra large flowering varieties	\$0.50
230	AMBROSIA mexicana . Sweet-scented annual. Useful in bouquets; 1 to 1 $\frac{1}{2}$ ft. $\frac{1}{4}$ oz. 40c	.10
235	AMPELOPSIS veitchi (Boston Ivy). Popular rapid growing hardy vine $\frac{1}{4}$ oz. 35c	.10
238	ANCHUSA, Blue Bird . Annual. Indigo blue..	.30
240	capensis . Annual. Fine azure blue Forget-me-not-like flowers. 1 ft. $\frac{1}{2}$ oz. 35c	.10
242	barrelieri . Perennial. Dwarf, blue.....	.25
245	italica, Dropmore Variety . Perennial. Gentian blue; 4 ft. $\frac{1}{4}$ oz. 85c	.25
246	Lissadell . Perennial. Bright gentian blue; 5 ft.35
248	Myosotidiflora . Perennial, 1 ft. May. A Russian variety with clusters of blue flowers resembling Forget-me-nots.....	.25
250	ANEMONE coronaria, St. Brigid . An improved strain of the hardy garden Anemone, with larger and more brilliant flowers; 1 ft.20
251	De Caen (French Anemone). Mixed15
253	ANTHEMIS arabica . Annual yellow10
255	kelwayi (Hardy Marguerite). A most satisfactory, hardy perennial, bearing throughout the summer golden yellow daisylike flowers, excellent for cutting; 2 ft. $\frac{1}{2}$ oz. 50c	.10
	ANTHERICUM . One of the finest ornamental garden plants, producing freely fine spikes of sweet scented, lily-like flowers from May to July. Hardy perennial. 1 $\frac{1}{2}$ ft.	
258	liliastrum Giant (St. Bruno lily). Large white, with green spots $\frac{1}{8}$ oz. \$1.00	.25

ANTIRRHINUM (Snapdragon). One of the most beautiful and useful bedding plants, blooming profusely and continuously throughout the summer and autumn. Our seeds of these are grown by specialists and are noted for the superior size and quality of their flowers.

TALL GIANT VARIETIES, 2 1/2-3 ft.

No.		Pkt.
270	Mixed. Finest sorts 1/4 oz.	60c \$0.15
272	Autumn Glow. Old rose shaded terra-cotta 1/4 oz.	65c .15
275	Cardinal. Dazzling scarlet 1/4 oz.	65c .15
280	Cattleya. Rosy lilac25
285	Copper King. Bronzy copper25
290	Crimson King. Deep crimson . . . 1/4 oz.	65c .15
295	Fairy Queen. Rich salmon-orange. 1/4 oz.	65c .15
300	Feltham Beauty. Deep rose-pink, white center 1/4 oz.	65c .15
305	Golden King. Giant yellow . . . 1/4 oz.	65c .15
310	Orange Beauty. Orange-scarlet, gold lip. 1/4 oz.	\$1.00 .25
315	Peachblow. Delicate peach with yellow.25
320	Pink Domino. Soft rose-pink, white throat, 1/4 oz.	65c .15
325	Queen Victoria. Pure white . . . 1/4 oz.	65c .15
330	Rose. Brilliant rose-pink 1/4 oz.	65c .15
336	Torchlight. Orange, yellow lip. . . 1/4 oz.	65c .15
338	Collection 8 varieties	1.00
SEMI-DWARF VARIETIES, 15 to 18 in.		
340	Art Shades. Ranging through pink, orange and terra cotta. 1 ft. 1/4 oz.	75c .15
345	Amber Queen. Canary-yellow, overlaid with chamois-pink, golden lip. 1/4 oz.	75c .15
347	Beacon. Beautiful salmon-rose with deeper gold-tipped center20
350	Carmine Queen. Rose-carmine . . 1/4 oz.	75c .15
355	Cottage Maid. Pale coral-pink, white throat 1/4 oz.	60c .15
360	Crimson Empress. Bright crimson 1/4 oz.	75c .15
365	Golden Queen. Pure yellow . . . 1/4 oz.	\$1.00 .15
366	Majestic "Eldorado." Self color, large, deep golden yellow flowers on dense spikes25
368	Majestic "Orange King."25
369	Majestic "Red Chief." Color rich deep scarlet25
372	Majestic "Twilight." Rosy salmon.25
373	Matchless. Apricot-buff, yellow center15
374	Pink Queen. Wild rose pink. . . . 1/8 oz.	75c .15
375	Purity. Pure white 1/4 oz.	85c .15
377	Rose Dore. Salmon-rose, shaded gold 1/4 oz.	85c .15
379	Rock Hybrids. Small, compact bushes. 1/8 oz.	\$1.00 .30
380	Mixed. Finest varieties 1/4 oz.	50c .10
385	Collection of 8 Varieties. Our selection.	1.00

TOM THUMB VARIETIES, 8 to 10 in.

Excellent for bedding, blooming all Summer.

390	Antique Rose 1/8 oz.	85c .15
395	Brilliant Crimson 1/8 oz.	85c .15
400	Bronze and Gold 1/8 oz.	85c .15
405	Canary Yellow 1/8 oz.	85c .15
410	Dark Scarlet 1/8 oz.	85c .15
412	Pinkie. Bright rosy pink. 1/8 oz.	85c .15
415	Snowflake. Extra pure white. . . 1/8 oz.	85c .15
420	Choice Mixed 1/8 oz.	85c .15
425	Collection of Six Varieties. Our selection75

AQUILEGIA (Columbine). Beautiful, free-flowering, hardy perennials, blooming profusely through the spring and early summer and of easiest cultivation. Early sown seed will bloom the same season. 1 1/2 to 3 ft.

430	Grey's Columbia Hybrids. Special long-spurred strain. The colors include the most charming combinations from the brightest to the most delicate tints. 1/8 oz.	\$1.50, 1/4 oz. \$2.50 .50
-----	--	----------------------------

No.		Pkt.
AQUILEGIA—Continued.		
435	canadensis. Scarlet and yellow, native species 1/8 oz.	75c \$0.15
440	chrysantha. Bright yellow 1/8 oz.	75c .15
445	chrysantha grandiflora alba. Large, pure white 1/8 oz.	\$1.00 .25
450	coerulea (Rocky Mountain Columbine). Splendid, large, light blue . . . 1/8 oz.	\$1.00 .25
460	coerulea, Rose Queen. Long spurs. 1/8 oz.	\$1.50 .25
462	Dobbie's Imperial Hybrids. . . . 1/8 oz.	\$1.50 .50
465	glandulosa. Deep blue, with white center.25
466	Long-spurred Pink Shades 1/8 oz.	\$1.50 .25
467	Mrs. Scott Elliott's Strain 1/8 oz.	\$1.50 .50
475	olympica. Large delicate mauve. . 1/8 oz.	75c .15
478	Orange and Scarlet Shades, Long Spurred. 1/8 oz.	\$1.50 .25
480	skinneri. Scarlet and yellow. . . 1/8 oz.	\$1.50 .25
482	Snow Queen, Long Spurred. . . 1/8 oz.	\$1.50 .25
485	Mixed Single Varieties 1/4 oz.	\$1.00 .10
490	Mixed Double Varieties 1/4 oz.	\$1.50 .25
500	ARABIS alpina. Hardy perennial, with pure white flowers blooming early in the Spring; valuable for edgings and rock-work; will grow well in rather shaded position. 1 ft. 1/4 oz.	50c .10
505	grandiflora superba. Improved, large flowers. 1 ft. 1/4 oz.	\$1.25 .15
510	ARALIA sieboldi. A most desirable foliage plant, well suited for the conservatory and for plunging in flower beds during summer. 2 to 3 ft.25
515	ARCTOTIS grandis. Handsome annual from South Africa, with large, daisy-like flowers, white, with light blue center, the under-side of petals being pale blue, 2 ft. 1/4 oz.	75c .15

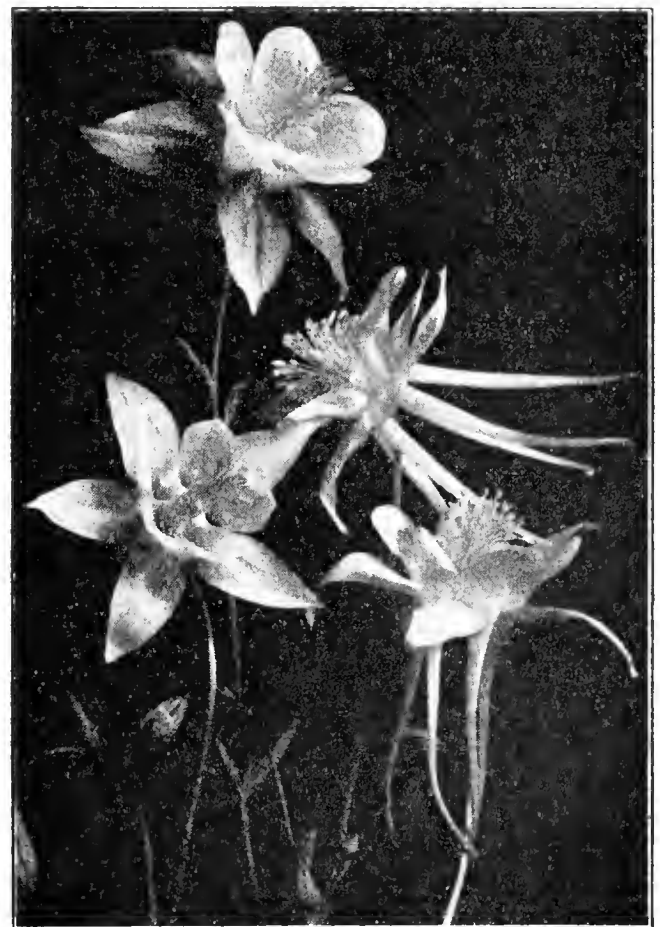

Grey's Columbia Hybrid Aquilegia.

No.		Pkt.	No.		Pkt.
520	ARGEMONE grandiflora. Annual. Large pure white poppy-like flowers; golden yellow center. 2 ft. ¼ oz. 50c	\$0.10	550	ASPERULA azurea setosa. Annual species of Woodruff, with fragrant, light blue flowers, blooming through the Summer and fine for cutting. It will grow in poor soil or in shaded places. 1 ft. ¼ oz. 50c	\$0.15
	ARMERIA (Thrift, or Sea Pink). Pretty, hardy perennial for edgings, blooming all summer; tufted flowers.		555	odorata (Sweet Woodruff). Hardy perennial, conspicuous in May by its pure white, sweet-scented flowers. The foliage and flowers when dried retain their fragrance. Grows well under trees.... ¼ oz. 85c	.15
525	formosa. Deep rose. 1 ft. ¼ oz. 60c	.10		ASPHODELUS. Showy plants with handsome flower spikes. They grow well in any soil. Hardy perennial.	
535	ASCLEPIAS tuberosa. One of the most showy of our summer and autumn flowering, hardy perennials, the umbels of bright, orange-colored flowers. 1½ ft.... ¼ oz., \$2.00	.25	570	luteus. Fine, yellow, fragrant. 3 ft. ¼ oz. \$1.00	.15
540	ASPARAGUS plumosus nanus. Beautiful house plants; the feathery foliage is unrivaled for cutting..... 100 seeds, \$1.25	.25			
545	sprengeri. Excellent plant for table decorations or to grow in pots or baskets... ¼ oz. 35c	.25			

Asters

NOTICE: Varieties marked with asterisk (*) are wilt-resisting.

No.		Pkt.	No.		Pkt.
575	COLUMBIA PRIZE. Double Mixed. This mixture is especially selected from the finest large flowering, double varieties, which grow about the same height, and includes the best of recent introductions. It is without an equal ¼ oz. \$1.25, oz. \$4.00, \$0.15	\$0.15		KING. Distinct from every other variety in the character of its flowers, which are of great size and substance, lasting longer when cut than any other class; the long, narrow petals are folded lengthwise, giving somewhat of a quilled appearance. The stems are exceptionally long and strong. They bloom with the late branching. 2 to 2½ ft.	
	AMERICAN BRANCHING, "LATE." Superb free flowering strain, with long, strong stems and very large, graceful chrysanthemum-like flowers, double to the center. By successive sowings they may be had in bloom from Aug. to late fall. 2 to 2½ ft.		630	Crimson. Rich crimson ¼ oz. 85c	.15
585*	Lavender ¼ oz. \$1.00, oz. \$3.00	.10	635	Lavender. Soft lavender-pink ¼ oz. 85c	.15
590*	Peerless Pink. Delicate. ¼ oz. 1.00, oz. 3.00	.10	638	Peach Blossom ¼ oz. 85c	.15
595*	Purple ¼ oz. 1.00, oz. 3.00	.10	640	Rose. Bright, deep rose ¼ oz. 85c	.15
600*	Rich Crimson ¼ oz. 1.00, oz. 3.00	.10	645	White. Snow-white ¼ oz. 85c	.15
605*	Rose Pink ¼ oz. 1.00, oz. 3.00	.10	650	Violet. Rich violet-purple ¼ oz. 85c	.15
610*	Shell Pink ¼ oz. 1.00, oz. 3.00	.10	652	Mixed ¼ oz. 75c	.15
615*	Snow White ¼ oz. 1.00, oz. 3.00	.10		ROYAL. A new class, with broad, incurved petals, possessing all the characteristics of the late branching, as to size of flower, vigor of plant, etc., but not quite so tall; they bloom earlier and are classed with the midseason varieties. 1½ to 2 ft.	
620*	Mixed. All colors..... ¼ oz. 1.00, oz. 3.00	.10	660*	Dark Lavender ¼ oz. 75c	.15
625*	Collection of Six Colors. Our selection.....	.50	662*	Lavender-Pink ¼ oz. 75c	.15
			665*	Purple. Rich, deep purple ¼ oz. 75c	.15
			666*	Rose ¼ oz. 75c	.15
			670*	Shell-Pink ¼ oz. 75c	.15
			675*	White. Glistening white ¼ oz. 75c	.15
			678*	Mixed ¼ oz. 75c	.15

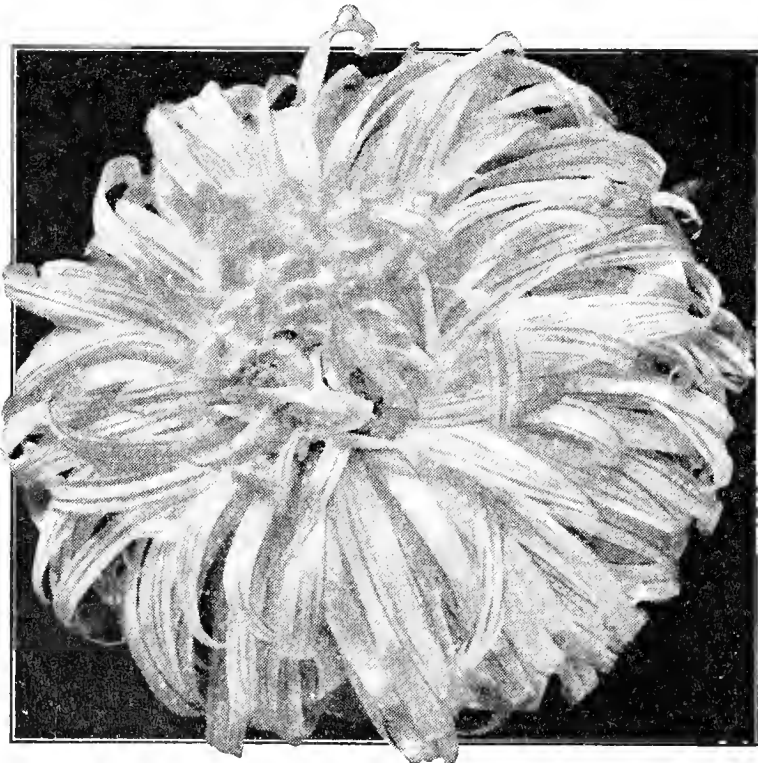

American Late Branching Aster.

660*	Dark Lavender ¼ oz. 75c	.15
662*	Lavender-Pink ¼ oz. 75c	.15
665*	Purple. Rich, deep purple ¼ oz. 75c	.15
666*	Rose ¼ oz. 75c	.15
670*	Shell-Pink ¼ oz. 75c	.15
675*	White. Glistening white ¼ oz. 75c	.15
678*	Mixed ¼ oz. 75c	.15

DOUBLE CALIFORNIA GIANTS. A variety of Aster of the improved Comet type. Very strong stems. Petals beautifully curved and twisted. 3 ft.

680	Collection of 5 colors, separate.	\$1.00
685	Dark Purple ¼ oz. 85c	.25
690	Deep Rose ¼ oz. 85c	.25
695	Light Blue ¼ oz. 85c	.25
698	Los Angeles. New Super Giant Shell Pink.. ¼ oz. \$1.00	.25
700	Peach Blossom ¼ oz. 85c	.25
705	White ¼ oz. 85c	.25
710	Mixed ¼ oz. 85c	.25

SEE PAGE 4 FOR SEEDS OF PLANTS SUITABLE FOR ROCK GARDEN



Crego's Giant Comet Asters.

No.		Pkt.
	CREGO'S GIANT COMET. Branching sort with large, full, fluffy flowers—through August and September. 2½ ft.	
711*	Azure-Blue ¼ oz. 75c	\$0.15
712*	Crimson ¼ oz. 75c	.15
715	Lavender ¼ oz. 75c	.15
716	Egyptian Rose. Deep cinnabar-rose..... ¼ oz. 75c	.15
720*	Purple. Fine color..... ¼ oz. 75c	.15
725*	Pink. Soft shell-pink ¼ oz. 75c	.15
730*	Rose. Clear, bright rose ¼ oz. 75c	.15
734	Venus. New silvery salmon-pink. ¼ oz. \$1.00	.20
735*	White. Pure snow white..... ¼ oz. 75c	.15
736	Mixed ¼ oz. 75c	.15
	OSTRICH PLUME, Improved. Enormous flowers on long stems. The petals are curled and twisted, blooming in August and September; excellent for cutting or exhibition. 2½ ft.	
740	Collection of following 6 colors, separate.	.75
745*	Crimson ¼ oz. 75c	.15
750*	Dark Purple ¼ oz. 75c	.15
755*	Lavender ¼ oz. 75c	.15
760*	Rose Pink ¼ oz. 75c	.15
765*	White ¼ oz. 75c	.15
770*	Shell-Pink ¼ oz. 75c	.15
775*	Finest Mixed ¼ oz. 75c	.15
	PLUME. "Early Wonder." Fine strain of this beautiful Aster, blooming in July and August. 1 ft.	
778	Crimson. ¼ oz. 75c	.15
780	Dark Blue ¼ oz. 75c	.15
785	Light Blue ¼ oz. 75c	.15
790	Rose ¼ oz. 75c	.15
795	White ¼ oz. 75c	.15
798	Mixed ¼ oz. 75c	.15
800	Lilliput Flowered Mixed. Plants 14-16 in. bearing an abundance of small button-like flowers. ¼ oz. 85c	.15
	QUEEN OF THE MARKET. The earliest flowering, first-class Aster. Coming into bloom 3 to 4 weeks earlier than other sorts. The flowers are of good size on long stems and extensively grown for cutting. 1½ ft.	

No.		Pkt.
	QUEEN OF THE MARKET ASTER (Continued)	
895	Collection of the following 6 colors	\$0.50
900*	Crimson ¼ oz. 75c, oz. \$2.00	.10
905*	Dark Blue ¼ oz. 75c, oz. 2.00	.10
910*	Flesh-Pink ¼ oz. 75c, oz. 2.00	.10
915*	Light Blue ¼ oz. 75c, oz. 2.00	.10
920	Rose ¼ oz. 75c, oz. 2.00	.10
925*	White ¼ oz. 75c, oz. 2.00	.10
930	Mixed. All colors ¼ oz. 75c, oz. 2.00	.10

EARLY AMERICAN BEAUTY. A fine, strong growing Aster with incurved petals. Blooms from July to frost. 2½ to 3 ft.

945*	Azure Fairy ¼ oz. 75c	.20
948*	Crimson ¼ oz. 75c	.20
950	Peach Blossom ¼ oz. 75c	.20
955*	Purple ¼ oz. 75c	.20
960*	Rose ¼ oz. 75c	.20
965*	Shell-Pink ¼ oz. 75c	.20
970*	White ¼ oz. 75c	.20
975*	Mixed ¼ oz. 75c	.20

OTHER ASTERS

976*	Ball Purple Early. Deep bright purple.... ¼ oz. 85c	.20
977*	Ball White Early. Branching ¼ oz. 85c	.20
978*	Heart of France. A pure red Aster. Very double, of strong, branching habit. It keeps its brilliant rich color when cut. ¼ oz. 75c	.15

980	Surprise Salmon Gold. Pure salmon-yellow, turning to a radiating salmon-pink. Peony type flowers on long stems. Begins blooming in July.25
-----	--	-----

SINGLE GIANTS OF CALIFORNIA. A new type of single Aster, with flowers measuring 3 to 4 in. across with stems 1½ to 2 ft. in length. The petals are slightly twisted.

981	Light Blue ¼ oz. 60c	.15
991	Purple ¼ oz. 60c	.15
996	Rose ¼ oz. 60c	.15
1001	White ¼ oz. 60c	.15
1006	Finest Mixed ¼ oz. 60c	.15

CALIFORNIA SINGLE GIANT IMPROVED "SUNSHINE." Crested flowers with golden centers; strong growing, with flower stems 2 ft. and over in length.

1011	Delicate Flesh Pink. ¼ oz. 85c	.20
1012	Lavender ¼ oz. 85c	.20
1015	Rose Pink ¼ oz. 85c	.20
1016	Violet ¼ oz. 85c	.20
1017	White ¼ oz. 85c	.20
1018	Mixed ¼ oz. 85c	.20

SINGLE ASTER ELEGANCE.

1028*	General Joffre. Large single aster of intense crimson-scarlet, on long stems. Excellent for cutting ¼ oz. 75c	.15
-------	--	-----

SOUTHCOTE BEAUTY SINGLE. 2 ft.

1030	Dark Blue20
1032	Mauve20
1035	Rose20
1038	Scarlet20
1040	White20
1045	Mixed20
1048	Collection 5 colors.75

No.	Pkt.	No.	Pkt.
<p>ASTER, Perennial Sorts (Michaelmas Daisies). We have in this class some of the most beautiful and interesting hardy plants grown; their graceful habit, profusion of bloom and variety of color form the chief attraction of the flower garden during the autumn months.</p>		<p>1115 BAPTISIA australis (False Indigo). Handsome hardy perennial, producing bright blue, pea-shaped flowers on spikes 6 inches long. 2½ ft. ¼ oz. \$1.00 \$0.15</p>	
1050	alpinus speciosus. Large, rich purple....\$0.25	<p>1120 BARTONIA aurea. Showy, hardy annual of distinct character, its large golden yellow flowers being freely produced; succeeds well in partial shade. 1½ ft..... ¼ oz. 50c .15</p>	
1055	subcoeruleus, Wartburg Star. Extra large, bright lavender-blue, yellow centers. Flowers 4 inches across, long stems. Extra early. 2 ft.25	<p>BEANS, Flowering.</p>	
1060	White Queen. Large white25	1125	Butterfly Runner. Large pink and white. ¼ lb. 50c; lb. \$1.50 .15
1065	Mixed Hybrids, New Large-Flowered Strain. 2 to 4 ft. ¼ oz. \$1.75 .25	1130	Scarlet Runner. Large, brilliant scarlet. Lb. 50c .10
<p>AUBRIETIA. These dwarf, hardy perennials are invaluable for the border, rockeries, etc.; they are among the brightest and most free flowering plants of early spring.</p>		1135	White Runner. Large, pure white. Lb. 50c .10
1070	graeca. Beautiful purple color25	<p>BEGONIA, Tuberous-rooted. These are easily grown from seed and may be had in bloom in about 6 months. They make a gorgeous display throughout the season and are excellent for bedding purposes, window boxes, etc., and as pot plants are effective for house and conservatory. 1 ft.</p>	
1075	leichtlini. Rosy red, very pretty25	1140	Double, Prize Mixed \$1.00
<p>AURICULA. See <i>Primula auricula</i>.</p>		1142	Blackmore & Langdon's Double Mixed... 1.00
<p>FACHELOR BUTTON. See <i>Centaurea</i>.</p>		1145	Single, Giant Mixed50
<p>BALSAM. These old-fashioned annuals, so easily grown, are again increasing in popularity, and most beautiful and brilliant effects may be had from them; overcrowding should be avoided and they should be set at least 18 inches apart for best results.</p>		1147	Blackmore & Langdon's Single Mixed... 1.00
1080	Columbia Prize. An unsurpassed strain in doubleness, size, brilliancy and variety of color ¼ oz. 75c .15	1150	Single Fringed. Unsurpassed strain50
1085	Dark Blood Red. Extra ¼ oz. 50c .10	1152	Blackmore & Langdon's Extra Frilled Mixed 1.00
1090	Intense Scarlet (The King) ... ¼ oz. 50c .10	1154	Blackmore & Langdon's Basket Begonia Mixed 1.00
1095	Rich Pink (Salmon King) ¼ oz. 50c .10	<p>BEGONIA, Fibrous-rooted. The following sorts are perpetual bloomers and extensively used for planting outside in beds and for pot culture in the greenhouse. 1 ft.</p>	
1100	White (Snowball). Superior ¼ oz. 50c .10	1155	gracilis. White Pearl. Pure white..... .25
1105	Mixed Rose-flowered. Very double ¼ oz. 40c .10	1160	Bonfire. Lustrous carmine, with brownish red foliage25
1110	BALLOON VINE. A rapid growing annual climber, with white flowers and inflated seed vessels which look like miniature balloons oz. 50c .10	1165	Mignon. Brilliant salmon-scarlet. 8 in. .25
		1170	luminosa. Dark scarlet, foliage deep.. .25
		1172	Prima Donna. Rose, carmine shaded.. .25
		1175	rosea. Fine rose-pink25

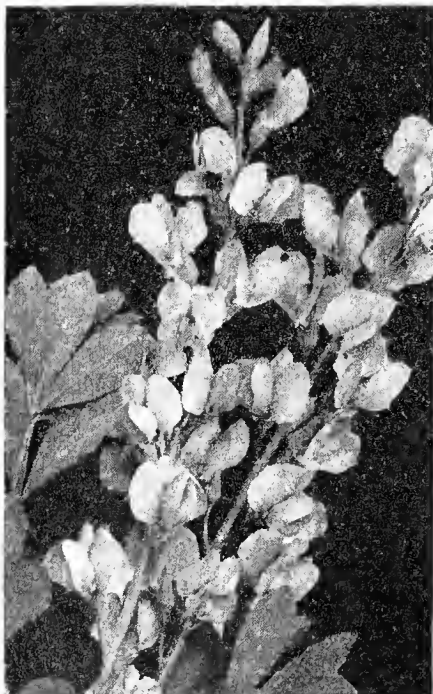

Baptisia australis.



Double Tuberous Begonia.



Balsam.

BEGONIA—Continued

No.		Pkt.
1180	erfordi, Glory of Erfurt. Lovely rose-carmine flowers, with dark, glossy, green foliage	\$0.50
1185	Salmon Queen. Brilliant salmon-red, passing to salmon-rose; the dark green foliage has a reddish hue50
1190	Triumph. Beautiful, large, snow white flowers; excellent50
1195	Vernon. Deep scarlet, with bronze foliage.25
1200	Vernon, Dwarf. Rich red, with glossy bronze foliage. 8 in.25
1205	Rex varieties, Mixed (Ornamental leaved). Large handsome variegated leaves75
1208	Semperflorens, Gustave Knaake. Glowing salmon-pink, leaves green. Excellent for pot culture35

BELLIS perennis fl. pl. (Double Daisy). Favorite perennials producing in Spring their handsome, double flowers, and are very effective when planted with Pansies or Forget-me-nots. Rich soil and cool situation suit them best.

1220	monstrosa, Rose. Extra large, ¼ oz. \$1.50	.25
1225	monstrosa, White. Extra large. ¼ oz. \$1.50	.25
1230	Quilled, Giant Red. Dark red25
1235	Quilled, Giant White. Pure white25
1240	monstrosa, Finest Mixed. Double..... ¼ oz. \$1.00	.15
1245	BOCCONIA japonica (Plume Poppy, or Tree Celandine). 5 ft. Ornamental, hardy perennial, with glaucous green foliage and spikes of creamy white flowers, 2 to 3 feet long.	¼ oz. 60c .15

1250	BOLTONIA latisquama. One of our showiest hardy perennials, with large clusters of lavender-pink, Daisy-like flowers. 5 ft.25
------	--	-----

BROWALLIA. Beautiful, profuse blooming bedding and pot plants. 1½ to 2 ft.

1255	speciosa major. Large, brilliant, ultramarine blue; splendid winter bloomer.35
1256	speciosa alba. Same habit as above50
1260	Mixed Elata. Shades of blue and white.. ¼ oz. 50c	.15

1265	BUPHTHALMUM Speciosus (Ox-Eye). Fine, hardy perennial, with large, golden yellow flowers on long stems, 5 ft... ¼ oz. 85c	.15
------	---	-----

BRACHYCOME (Swan River Daisy). Profuse flowering, low growing annual, with pretty Daisy-like flowers; doing best in warm and dry situations. 9 in.

1270	Blue Star. Beautiful bright blue. ¼ oz. 50c	.15
1275	rosea. Fine color	¼ oz. 75c .15
1280	Mixed.	¼ oz. 50c .10

1285	CACALIA coccinea (Tassel Flower). A neat, free blooming annual, with scarlet tassel-like flowers. All summer. 1½ ft.	¼ oz. 35c .10
------	--	---------------

1290	CACTUS. Succulent plants. Excellent mixture of American grown varieties, suitable for growing in pots in house or conservatory25
------	---	-----

CALCEOLARIA. Our seeds are from noted English growers and saved from the finest strains grown, which have been awarded the leading prizes.



Calendula.

No.		Pkt.
1295	Covent Garden Strain. Extra choice, strongly recommended for habit, size and marketing of flowers	\$0.75
1300	KELWAY'S Perfect Model. Medium height. Of splendid habit. Heads of very large flowers. The richest and most delicate colors	1.00
1301	rugosa, or Shrubby, Mixed. Choice bedding varieties, with innumerable flowers.50
1302	Scabiosafolia. Annual, 2 ft. Free flowering with small bright yellow flowers.....	.25
	CALENDULA officinalis fl. pl. (Pot Marigold). Valuable, hardy annual, the double showy flowers making a grand display for months; suitable for dry places. 1½ to 2 ft.	
1303	Art Shades. Contains apricots, picotees, orange and cream tones.....	¼ oz. 40c .15
1304	Ball's Apricot. Brown center	Oz. \$1.50 .15
1306	Ball's Gold. Deep golden	Oz. \$1.50 .15
1307	Ball's Orange. Light center	Oz. \$1.50 .15
1308	Campfire (Sensation). Dark orange. Light center	¼ oz. 60c .15
1309	Chrysantha. Lovely new Chrysanthemum flowered type with petals long and wide, of clear buttercup yellow. Long stiff stems.25
1310	Lemon Queen. Lemon yellow	Oz. 50c .10
1312	Masterpiece. Deep orange, brown center, long stems15
1315	Meteor. Lemon, striped orange.	Oz. 50c .10
1320	Orange King. Large, dark orange. ..	Oz. 75c .10
1325	Orange Shaggy. Long, deeply fringed petals. Deep orange, lighter toward the center25
1328	Radio. Deep orange, quilled10
1330	Mixed. Double all shades	Oz. 35c .10



Calliopsis drummondii.

No.		Pkt.
	CALLIFLOPPY. (See Eschscholtzia.)	
	CALLIOPSIS , or COREOPSIS . Showy, hardy annuals, very continuous in flowering, and most useful for cutting. 1½ to 2 ft.	
1335	coronata maxima . Large yellow. ¼ oz. 40c	\$0.10
1340	drummondii (Golden Wave). Golden yellow, with brown center . . . ¼ oz. 40c	.10
1345	Fire King . Deep, bright scarlet, cactus-shaped petals15
1351	Garnet . 1 ft. Dwarf glossy crimson-scarlet15
1352	Golden Ray . 10 in. Gold, maroon center..	.15
1353	Star of Fire . 10 in. Garnet-brown15
1354	Tiger Star . 10 in. Bright yellow and maroon15
1355	Mixed . Fine varieties.. ¼ oz. 25c,	oz. 75c .10
	CALLIOPSIS , or COREOPSIS . Hardy Perennial Varieties . Early sown seed will bloom the same season, but it is better to sow in July and protect lightly in winter.	
1365	Mayfield Giant . California strain. Large golden yellow flowers . . ¼ oz. \$1.00	.25
1370	grandiflora . Bright, golden yellow ¼ oz. 50c	.10
1375	lanceolata . Large, bright yellow. ¼ oz. 60c	.15
1380	CALLIRHOE involucrata (Poppy Mallow). Showy, hardy perennial of spreading growth, with large, bright crimson, saucer-shaped flowers from early summer till fall. 1 ft. . . . ¼ oz. 60c	.15
	CAMPANULA (Bellflower). Beautiful well-known hardy perennial and one of our most attractive garden flowers, noted for their rich colors and profusion of bloom.	
1385	carpatia . Erect blue flowers all Summer; useful for borders or rockery. 9 in. ¼ oz. \$1.00	\$0.15

No.		Pkt.
1390	carpatia alba . Erect, white flowers. 9 in. ¼ oz. \$1.00	\$0.15
1395	mirabilis . Large, pale blue; extra. 2 ft.	.50
1400	moerheimi . Large, white, saucer-shaped flowers. 2 ft. ½ oz. \$1.50	.25
1405	persicifolia grandiflora . Large, bright blue; one of the best. 2 ft. . . ½ oz. 85c	.25
1410	persicifolia grandiflora alba . Large, pure white. 2 ft. ½ oz. 85c	.25
1415	persicifolia grandiflora pfitzeri . Large, light blue, double and semi-double. 2 feet25
1418	persicifolia grandiflora. Telham Beauty . Largest blooms of soft lavender. 2½ feet50
1420	persicifolia grandiflora. Mixed25
1425	pyramidalis (Chimney Bellflower). Blue. 4 ft. ½ oz. 60c	.15
1430	alba. White . 4 ft. ½ oz. 75c	.15
1433	compacta, Mixed . Much more dwarf and free blooming than preceding15
	CAMPANULA medium (Canterbury-bells). Showy, hardy biennials, about 3 ft. high, of pyramidal form, and profusely covered with large, bell-shaped flowers. calycanthema (Cup-and-saucer Varieties).	
1440	Blue ¼ oz. \$1.00	.15
1445	Rose Pink ¼ oz. \$1.00	.15
1450	White ¼ oz. \$1.00	.15
1455	Mixed . All colors ¼ oz. \$1.00	.15
1457	Double Mixed35
1460	Single, Blue ¼ oz. 50c	.10
1465	Rose Pink ¼ oz. 50c	.10
1470	Reddish Violet ¼ oz. 50c	.10
1475	Mauve ¼ oz. 50c	.10
1480	White ¼ oz. 50c	.10
1485	Mixed . All colors ¼ oz. 50c	.10
1490	Double, Blue ¼ oz. \$1.00	.15
1495	Rose Pink ¼ oz. \$1.00	.15
1500	White ¼ oz. \$1.00	.15
1505	Mixed . All colors ¼ oz. \$1.00	.15
1510	Columbia Prize Mixture . All colors of all varieties, unsurpassed . . . ¼ oz. \$1.00	.25

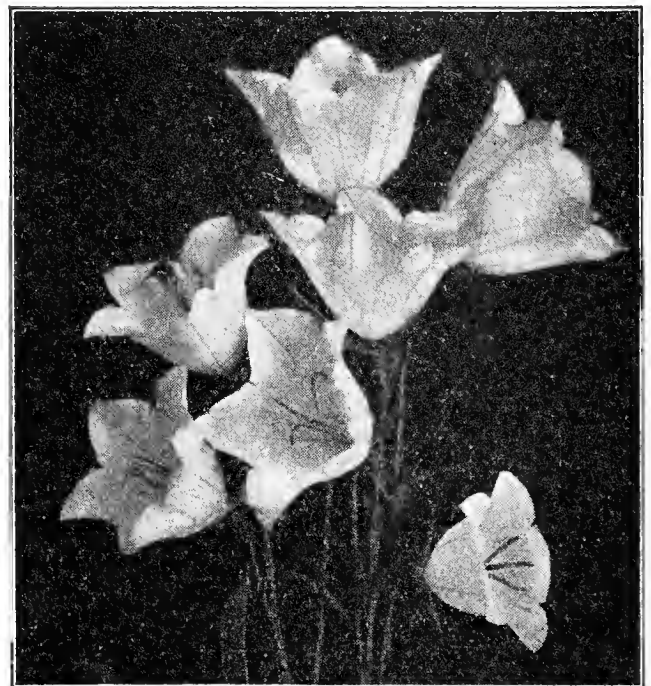

Campanula persicifolia.

No.		Pkt.
	CANDYTUFT. Fine for edgings and cut flowers, Hardy annual. 1 ft.	
1515	Carmine. Carmine-rose ¼ oz. 40c, oz. \$1.50	\$0.15
1520	Crimson ¼ oz. 25c, oz. 75c	.15
1525	Dobbies White Spiral. A superior strain of the large flowered white from the introducer ¼ oz. 50c, oz. \$1.50	.10
1530	Empress. Immense, pure white, pyramidal trusses ¼ oz. 35c, oz. \$1.00	.10
1532	Flesh Pink ¼ oz. 40c	.10
1535	Giant Perfection. Immense, pure white spikes. Special selection ¼ oz. 60c, oz. \$2.00	.15
1536	Lavender ¼ oz. 20c, oz. 50c	.10
1537	Pyramidal Perfection. Very large, white, fine for greenhouses ¼ oz. 60c	.15
1542	Rose Cardinal ¼ oz. 50c	.15
1545	Mixed. All colors ¼ oz. 15c, oz. 40c	.10
1550	Dwarf Rose ¼ oz. 60c, oz. \$1.75	.15
1555	White ¼ oz. 60c, oz. \$1.75	.15
1556	Flesh Pink ¼ oz. 60c	.15
1558	Crimson ¼ oz. 60c	.15
1560	Mixed Hybrids ¼ oz. 50c, oz. \$1.50	.10
	CANNAS Handsome foliage. Soak the seed in hot water 24 hours before sowing. 3 to 4 ft.	
1565	Crozy's New Large-Flowering Varieties Newest and best sorts Oz. 60c	.10
	CARDINAL CLIMBER. See <i>Ipomoea Quamoclit.</i>	
	CARNATION PINKS. See <i>Dianthus.</i>	
	CASTOR OIL BEANS. See <i>Ricinus.</i>	
	CATCHFLY. See <i>Silene.</i>	
	CELOSIA cristata, or COCKSCOMB. Free blooming annuals; large, brilliant Cockscomb-like heads. They prefer a light soil, not too rich; fine border or pot plant.	
1575	Collection 5 following colors, separate	.60
1580	Dwarf Bright Rose. ¾ ft. .. ½ oz. \$1.00	.15
1585	Copper Color. ¾ ft. ½ oz. \$1.00	.15
1590	Dark blood Red. ¾ ft. ½ oz. \$1.00	.15
1595	Glasgow Prize. Dark crimson. ¾ ft. ½ oz. \$1.25	.15
1600	Golden Yellow. ¾ ft. ½ oz. \$1.25	.15
1610	Mixed. Finest colors. ¾ ft. ½ oz. 75c	.10
1615	Tall Mixed. All colors. 2 to 3 ft. ½ oz. 20c	.10
	CELOSIA thompsoni magnifica, Improved Feathered Cockscomb. A magnificent and valuable annual, with long, feathery plumes of the richest colors, varying from pale yellow to the deepest crimson. Effective during summer and fall. 2 ft.	
1617	childsi (Chinese Woolflower)15	
1620	Carmine ½ oz. 50c	.15
1625	Crimson ½ oz. 50c	.15
1630	Golden Yellow ½ oz. 50c	.15
1635	Light Yellow ½ oz. 50c	.15
1640	Scarlet ½ oz. 50c	.15
1645	Triumph of Exposition. Crimson, dark red stems ½ oz. 50c	.15
1650	Mixed. All colors ½ oz. 50c	.15
1660	CELSIA arcturus. A fine, half hardy plant, very pretty for pot culture in a cool house. The long spikes of bright yellow flowers are produced the same season from spring sown seed. 1 ft.50
1662	cretica. Large yellow flowers in long spikes. 6 ft. H. H. B.50

No.		Pkt.
	CENTAUREA (Dusty Miller). Silver foliaged plants, extensively used for edgings, baskets, etc. Half-hardy perennial.	
1665	candidissima. Thick foliage. 1 ft. ½ oz. 50c	\$0.15
1670	gymnocarpa. Very graceful. 1½ ft. ¼ oz. 50c	.15
	CENTAUREA, Annual Varieties. Very free flowering, with handsome, showy flowers; useful for cutting. 2 to 2½ ft.	
1675	americana. Reddish lilac. ¼ oz. 60c	.15
1676	americana alba ¼ oz. 75c	.20
1680	Cyanus, Mixed (Bachelor Button) oz. 60c	.10
1685	Double, Mixed oz. \$1.00	.10
1690	Single Blue oz. 50c	.10
1695	Double Blue ¼ oz. 50c	.15
1696	Double Carmine ¼ oz. 40c	.15
1698	Double Mauve ¼ oz. 40c	.15
1700	Double Purple ¼ oz. 40c	.15
1705	Double Rose ¼ oz. 40c	.15
1710	Double White ¼ oz. 40c	.15
	Imperialis (Royal Sweet Sultan). Very large, sweet scented flowers. 2 to 3 ft.	
1715	Bright Pink ¼ oz. 60c	.15
1720	Dark Purple ¼ oz. 60c	.15
1725	Deep Lavender ¼ oz. 60c	.15
1730	Lilac ¼ oz. 60c	.15
1735	White ¼ oz. 60c	.15
1740	Mixed. All colors ¼ oz. 60c	.15
1745	Moschata (Sweet Sultan). Purple ¼ oz. 20c	.10
1748	Rose ¼ oz. 20c	.10
1755	White ¼ oz. 20c	.10
1760	Mixed ¼ oz. 20c	.10
1765	Suaveolens. Yellow Sweet Sultan ¼ oz. 50c	.15
	CENTAUREA, Perennial Varieties. Desirable, hardy plants, with showy thistle-like flowers from July to September.	
1770	macrocephala. Large yellow. 3 ft.15
1775	montana. Deep purple. 2 ft. .. ¼ oz. 75c	.15
1780	alba. Large white. 2 ft. ¼ oz. 75c	.15
1790	CERASTIUM tomentosum (Snow-in-summer). A white foliaged hardy perennial, with small, white flowers; fine for edgings and rockeries. 4 in. ½ oz. 75c	.25

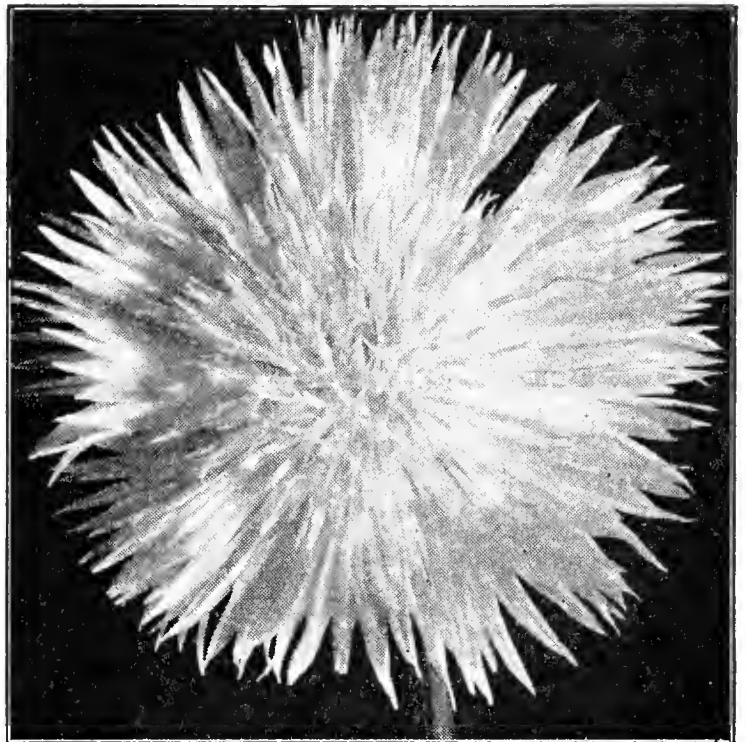

Centaurea Imperialis.



Cineraria.

No.		Pkt.
1792	CHEIRANTHUS allioni (Siberian Wallflower). Excellent dwarf perennial for rockery or margin of herbaceous border, brilliant orange flowers in spring and all summer if seed pods are removed. 1 ft. ¼ oz. 75c	\$0.20
1794	linifolius (Alpine Wallflower). Dwarf, mauve, fragrant. 1 ft.25
	CHELONE. Pentstemon-like spikes of brilliant colored flowers from July to October. Hardy perennial, 2 ft.	
1795	barbata torreyi. Scarlet ½ oz. 75c	.15
1800	Hybrid, Mixed. Beautiful..... ½ oz. 60c	.15
1802	CHORIZANTHE Palmeri (Turkish Rugging). 8 in. Excellent annual for rock gardens, forming a dense mat of statice-like flowers on dull green foliage15
	CHRYSANTHEMUM. Showy and effective summer flowering plants, blooming from July until frost; very desirable for the garden and for cut flowers.	
	Double-flowering Annual Varieties. 2 ft.	
1805	Golden yellow ¼ oz. 60c	.15
1808	Scarlet ¼ oz. 60c	.15
1810	White ¼ oz. 60c	.15
1815	Mixed. All colors ¼ oz. 40c	.10
1820	Fringed Hybrids. All colors .. ¼ oz. 50c	.15
	Single-flowering Annual Varieties. 2 ft.	
1825	atrococcineum. Scarlet ¼ oz. 35c	.10
1830	Evening Star. Large golden ¼ oz. 60c	.10
1835	Morning Star. Large primrose ¼ oz. 60c	.10
1840	Northern Star. Large white, yellow center, with dark disc ¼ oz. 60c	.10
1845	Mixed. All colors Oz. 60c	.10
1850	Grey's Special Mixture. All colors in double, single and fringed. .. ¼ oz. 60c	.15
1852	Cascade, or Balcony. Annual Large clusters of small single flowers. Plant is of the trailing type and attractive in a window box or pot25
	CHRYSANTHEMUM, Perennial Varieties.	
1855	frutescens (Paris Daisy). Single white, fine for winter blooming. 1½ ft.....	.15
1860	Mawil. Rich rose pink flowers on a dwarf plant. Ideal for borders or rockeries...	.35
1870	Shasta Daisy, Alaska. One of the best hardy white flowers for cutting; large, single25
1875	Pompon-flowered. The double, small-flowered hardy sorts; fine colors25
	CINERARIA. One of the most beautiful plants for house or conservatory during the spring months. Seeds should be sown from May to September.	

No.		Pkt.
	multiflora grandiflora maxima. A hybrid between "multiflora nana" and "grandiflora" having blooms of the grandiflora and many flowers of multiflora nana. 12 to 16 inches above the pot.	
1876	Light Rose	\$1.00
1877	Salmon-Rose	1.00
1878	Carminé	1.00
1879	Dark Red	1.00
1881	Cornflower Blue	1.00
1882	Marine Blue	1.00
1883	White	1.00
1884	Mixed	1.00
1880	Grey's Exhibition Prize. Acknowledged by our customers to be the finest strain grown; of compact branching habit, with exceptionally large flowers of the richest and brightest colors.	1.00
1885	grandiflora alba. Large pure white75
1890	atrosanguinea. Large blood red75
1895	azurea. Large, light blue75
1898	Dark Blue75
1900	kermesina. Large, bright crimson75
1902	Matador. Glowing scarlet75
1905	Pink shades. Very fine75
1910	Dwarf Large-flowering Mixed. Dwarf, compact habit with immense trusses of large flowers in rich colors75
	multiflora nana. A new Cineraria created by a Swiss florist. Makes a beautiful pot plant. Very compact growth, 10 in. above the pot. Leaves rather smaller than the grandiflora type of Cineraria. Flowers slightly more than 1 inch in diameter with centers varying from yellow to brown.	
1911	Dark Blue75
1912	Deep Red75
1913	Lavender75
1914	Light Blue75
1915	Pure White75
1916	Pink75
1917	Rose75
1918	Mixed75
1919	stellata, Feltham Beauty. Extra mixed...	.75
1920	stella grandiflora. Large flowers, with twisted or fluted petals like the single Cactus Dahlia75
1925	maritima candidissima, Diamond (Dusty Miller). White foliage for borders.... ¼ oz. 35c	.15
	CLARKIA. Very showy and profuse flowering hardy annuals of easy culture; very useful for cutting. 2 ft.	
1928	Double Appleblossom ¼ oz. 50c	.15
1930	Brilliant. Bright orange ¼ oz. 50c	.15
1931	Crimson Queen ¼ oz. 60c	.20
1932	Enchantress. Orange shading to pink.. ¼ oz. 50c	.15
1935	Orange King. Orange-scarlet.. ¼ oz. 50c	.15
1940	Purple Prince. Rich purple.. ¼ oz. 50c	.15
1945	Queen Mary. Rose-carmine .. ¼ oz. 50c	.15
1950	Salmon Queen. Salmon-pink ¼ oz. 50c	.15
1952	White15
1955	Mixed. Extra fine colors... ¼ oz. 25c	.10
	CLEMATIS. Well known as valuable, hardy, profuse flowering, climbing perennials.	
1965	Jackman's New Hybrids. Elegant large-flowered sorts ¼ oz. \$1.00	.25
1970	paniculata. Vigorous grower and covered in autumn with a cloud of star-like, fragrant white flowers ¼ oz. 35c	.10
1975	CLEOME pungens (Spiderflower). An attractive annual. 4 ft. Flowers rose with long stamens ¼ oz. 75c	.15
1976	alba. White15
1980	CLIANTHEUS dampieri (Glory Pea). A magnificent greenhouse annual, with large brilliant scarlet, pea-shaped flowers having a black center25



Double Crested Cosmos.

No.		Pkt.
1985	COBAEA scandens. Popular half hardy, climbing perennial of rapid growth, with large, purple, bell-shaped flowers; blooming first season from seed which should be planted edgewise. 20 ft. ¼ oz. 30c, oz. \$1.00	\$0.15
1990	scandens alba. White flowered.....	.25
1993	Mixed. ¼ oz. 30c, oz. \$1.00	.10
	COCKSCOMB. See <i>Celosia</i> .	
2001	COLCHICUM autumnale (Meadow Saffron, or Fall-blooming Crocus). Bulbous perennial ½ oz. 35c	.10
	COLEUS. Ornamental foliage plants, easily grown from seed. Half hardy perennial.	
2005	Mixed Hybrids. From a large collection..	.15
2010	New Large-leaved Varieties. Extra fine...	.25
2015	COLLINSIA, Mixed. Free flowering, hardy annuals of deserved popularity, blooming from June to October, and suited to dry situations ¼ oz. 20c	.10
2020	COMMELINA coelestis. Half hardy tuberous-rooted perennial, with sky-blue flowers; blooms first season. 1½ ft.15
2025	CONVOLVULUS minor, Mixed. Handsome, hardy annual, with large, richly colored flowers, producing a brilliant effect. 1 ft. Oz. 40c	.10
	major. See <i>Ipomoea</i> .	
	COSMOS. One of the most beautiful and useful of the hardy annuals, producing through the season thousands of beautiful flowers. Seed should be sown in May in the open ground. The early varieties will bloom from July till frost. 4 to 6 ft.	
	Double Crested. Early blooming.	
2026	Carnelia. Crimson ¼ oz. \$1.00	.25
2027	Peach Blossom. Pink ¼ oz. 1.00	.25
2028	Whirlwind. White ¼ oz. 1.00	.25
2029	Finest Mixed ¼ oz. 1.00	.25
2030	Extra Early, Mammoth Midsummer, Mixed. The blossoms, under ordinary field cultivation, average 4 to 5 inches across, surpassing in size any of the late varieties ¼ oz. 85c	.15

COSMOS—Continued.

No.		Pkt.
	From seed sown in the open ground, the White blossoms in 60 days, Pink in 65 and the Crimson in 70 days.	
2035	White. 4 ft. ¼ oz. 75c, oz. \$2.50	\$0.15
2040	Pink. 4 ft. ¼ oz. 75c, oz. \$2.50	.15
2045	Crimson. 4 ft. ¼ oz. 75c, oz. \$2.50	.15
	Mammoth. Late flowering. 5 ft.	
2055	Crimson ¼ oz. 50c	.10
2060	Lady Lenox. Shell-pink..... ¼ oz. 75c	.15
2065	Lady Lenox. White..... ¼ oz. 75c	.15
2085	CUPHEA platycentra (Cigar Plant). Dwarf, half hardy perennial, with bright scarlet, tubular flowers, tipped with black; blooms freely from seed. Fine pot plant. 1 ft.25
	CYCLAMEN. The seed we offer is saved by a leading specialist from selected strains of the very best varieties, and cannot fail to produce flowers of the largest size, finest substance and most charming shades of color. July to August is the best time for sowing. Seedlings should be grown on without any check whatever, and when grown cool the results are more satisfactory.	
2105	Giant America. Imp. Salmon-scarlet....	.75
2110	Blood Red75
2111	Bonfire75
2138	Lavender. Self color, very large.....	1.00
2140	Orange Beauty.	1.00
2142	Pink Pearl. Large, pale salmon.....	1.00
2143	Perle of Zehlendorf. Deep salmon.....	.75
2150	Pure Rose. Rich color.....	.75
2152	Rose of Marienthal. Pink, red eye....	.75
2157	Rose of Zehlendorf. Light salmon....	.75
2160	Saffron. Red	1.00
2161	Saffron. Silver Edge.	1.00
2162	White75
2165	White, Carmine Eye75
2180	Grey's Giant Mixture. All colors75
	For above named Cyclamen, 100 seeds \$2.50, 1000 seeds \$18.00	
2182	CYNOGLOSSUM amabile (Chinese Forget-me-not). Annual of easy culture. Heavenly blue	\$0.15
2184	Amabile Pink. Habit same as the above..	.20
2185	CYPERUS alternifolius (Umbrella Plant). Numerous erect stems, supporting in an umbellate manner a quantity of glossy, long, narrow leaves; excellent for house or greenhouse. 1 ft.25
2190	Papyrus (Egyptian Paper Plant). Palm-like foliage; an aquatic or for pots. 5 ft.25
	CYPRESS VINE. See <i>Ipomea quamoclit</i> .	
	DAHLIA. This popular flower can be easily raised from seed flowering the same season. Seed should be sown early in gentle heat. Half-hardy perennial 4 to 6 ft.	
2195	Cactus, Double Mixed. Saved from a fine collection ¼ oz. \$2.00	.25
2198	Coltness Hybrids. 18-24 in. Single flowers on long stems.25
2199	Coltness Mignon. Very dwarf, extra fine bedder. Mixed25
2200	Peony-flowered Giant. Single and semi-double flowers of enormous size, resembling the Peony..... ¼ oz. \$2.00	.25
2205	Pompon, Double Mixed. Small flowered..	.25
2210	Show, Double Mixed. Large flowered....	.25
2215	Single Giant Perfection. Surpassing all others in size and colors.... ¼ oz. \$1.50	.25
	DAISY. See <i>Bellis perennis</i> .	



Kelway's Show Delphiniums.

No.		Pkt.
2280	Mixed	1/8 oz. 40c \$0.20
2285	Collection of 6 packets	1.00
2300	Azure Fairy. Clear, light blue. 15 in.25
2301	Blue Gem. Deep blue. 9 to 12 in.15
2305	Blue Butterfly. Bright blue. 15 in.	1/4 oz. \$1.00 .25

DELPHINIUM, Hardy Perennial Varieties.

From seed they are of easy culture and produce splendid spikes of bloom through the summer. When sown early they usually bloom in September. 1 to 5 ft.

2310	Columbia Hybrids. An exceptionally fine strain selected from the best large flowering varieties, immense spikes.	1/4 oz. \$1.50 .25
2312	Blackmore and Langdon's Prize Strain. A world famous strain . . . 1-16 oz. \$1.50	.50
2315	Kelway's Show, Mixed. Saved from their celebrated collection of show varieties, which is undoubtedly the largest and finest collection of this popular perennial in existence 1-16 oz. \$1.50	.50
2325	Belladonna Improved. Clear turquoise blue; the everblooming, hardy Larkspur; if sown early will bloom in late summer and autumn 1/8 oz. \$1.25	.25
2326	Bellamosum. Deep blue 1/8 oz. \$1.25	.25
2340	chinense (grandiflorum). Large, deep blue. 1 1/2 ft. 1/4 oz. 85c	.10
2345	chinense album. Large white. 1/4 oz. 85c	.10
2348	chinense, Cambridge Blue. Clear Belladonna blue. 2 to 3 ft.25
2365	formosum coelestinum. Light blue. 2 1/2 ft. 1/8 oz. \$1.25	.25
2367	Hollyhock Delphinium, Wrexham Hybrids.	.50
2370	Hybrids, Wrexham, Pale Blue Shades. From newest large flowering sorts. 1/8 oz. \$1.25	.25
2375	Hybrids, Wrexham, Dark Blue Shades. From new, large flowering sorts 1/8 oz. \$1.25	.25
2380	King of Delphiniums. Deep blue, white center 1/8 oz. \$1.25	.25

DIANTHUS, or PINKS. Annual Varieties.

These are really hardy biennials though treated as annuals, and bloom the first season from early summer until frost. They are beautiful border plants and deserve a place in every garden.

DOUBLE-FLOWERING VARIETIES		
2385	chinensis, Mixed. Indian Pink. 1/4 oz. 40c	.10
2390	diadematus, Mixed, Diadem Pink. 1/4 oz. \$1.00	.15
2395	heddewigi, Mixed, Japan Pink 1/4 oz. 60c	.10
2400	laciniatus, Mixed. Lace Pink. 1/4 oz. 60c	.10
2405	latifolius, Mixed. Large flowers, resembling the Sweet William in shades of rose, crimson and maroon. 1/4 oz. 75c	.10
2410	nobilis, Mixed (Royal Pink). Largest size and brightest colors 1/4 oz. 50c	.10
2415	Blood Red. Deep color; extra. 1/4 oz. 75c	.10
2420	Mourning Pink. Deep crimson, white edge. 1/4 oz. 75c	.10
2425	Salmon Pink (Salmon King). 1/4 oz. \$1.00	.20
2430	White. Very fine variety. 1/4 oz. 75c	.10
SINGLE-FLOWERING VARIETIES		
2435	Crimson Belle. Dark red. 1/4 oz. 75c	.10
2440	The Bride. White, purple eye 1/4 oz. 60c	.10
2445	Vesuvius. Brilliant scarlet 1/4 oz. 50c	.10
2450	Mixed. Finest colors and sorts. 1/4 oz. 50c	.10

DIANTHUS caryophyllus (Carnation Pink).

2455	Riviera Market (Giant of Nice). Superior class of perpetual flowered Carnations.50
------	--	-----

No. Pkt.

DATURA (Trumpetflower). Handsome, hardy annuals of very rapid growth, with large, trumpet-shaped flowers. 3 ft.

2240	Double Mixed. All sorts 1/4 oz. 35c	\$0.15
------	---	--------

DELPHINIUM, Annual Varieties (Larkspur). Among the best of hardy annuals, lasting a long time in flower. The plants should be transplanted or thinned out to avoid over-crowding and to secure the branching habit.

TALL BRANCHING STOCK FLOWERED. 3 ft.

2244	Appleblossom Pink 1/4 oz. 50c	.15
2246	Brilliant Carmine 1/4 oz. 50c	.15
2248	Dark Blue 1/4 oz. 50c	.15
2250	Empress. Rose-pink 1/4 oz. 50c	.15
2252	La France. Salmon-pink 1/4 oz. 50c	.15
2254	Light Blue 1/4 oz. 50c	.15
2256	Newport Scarlet 1/4 oz. 50c	.15
2257	Rosamond. Pure rose, does not fade. 1/4 oz. 75c	.20
2258	White 1/4 oz. 50c	.15
2260	Mixed 1/4 oz. 50c	.15
2262	Collection of 6 packets75

GIANT IMPERIAL 4 ft.

2263	Blue Bell. Clear light blue20
2264	Blue Spire. Deep blue 1/8 oz. 40c	.20
2266	Lilac Spire 1/8 oz. 40c	.20
2268	White Spire 1/8 oz. 40c	.20
2270	Exquisite Soft Pink Imp. 1/8 oz. 40c	.20
2272	Exquisite Rose 1/8 oz. 40c	.20
2274	Gloria. Rich, deep rose. 1/8 oz. 40c	.20
2276	Los Angeles. Rose on salmon ground. 1/8 oz. 40c	.20
2278	Peach Blossom. Clear light pink. 1/8 oz. 40c	.20

No.		Pkt.
2460	Marguerite, Giant Mixed. Improved and very large, double-flowered strain of this early flowering Carnation which blooms in four months from time of sowing 1/8 oz. 75c \$0.20	
2462	Giant Rose 1/8 oz. 75c .20	
2465	Giant Scarlet 1/8 oz. 75c .20	
2470	Giant Yellow 1/8 oz. 75c .20	
2475	Giant White 1/8 oz. 75c .20	
	Chaubaud's Giant Improved French Carnation. Half hardy perennial. Seed sown early inside will bloom in six months. Clove-scented.	
2479	Cardinal Red (Sparkler)25	
2481	Crimson (Nero)25	
2483	Flesh Pink25	
2491	Rose Pink (The Pearl)25	
2492	Salmon Rose25	
2493	White (Jeanne Dionis)25	
2496	Yellow (Marie Chaubaud)25	
2497	Finest Mixed25	
2500	DIANTHUS deltoides Brilliant. (Maiden Pink). Beautiful, hardy sort for rockeries, sunken gardens, etc. The flowers are bright pink, small and in abundance from May to Aug. 6 in. 1/4 oz. 85c .15	
2505	deltoides albus. White flowers .. 1/4 oz. 85c .15	
2508	DIANTHUS (Hardy Carnation) allwoodi. A new race of Hardy Pinks, very free flowering and producing about 75 per cent of double flowers. Mixed colors.... .50	
2520	scoticus fl. pl. Perfection. Prize strain of double Scotch or florists' Pinks in finest colors50	
2524	Sweet Wivelsfield. A hybrid of many colors. Seed started inside early will flower outside from early June to November. Seed planted outside in spring will flower the same season. Seed planted outside in July or August will flower early the following spring25	
2525	DIANTHUS plumarius (Hardy Garden or Clove Pink). Double mixed. Free blooming strain, with double or semi-double flowers of spicy odor; in finest colors 1/4 oz. \$1.00 .25	
2528	DIASCIA barbarae. 1 ft. coral-pink. Charming little rock garden annual.15	
2530	DICTAMNUS, Mixed (Fraxinella). Gas Plant. Very showy, hardy perennial... 1/4 oz. \$1.00 .15	
2532	DIDISCUS coeruleus (Blue Lace Flower). Hardy annual. 18 in..... 1/8 oz. 50c .15	
	DIGITALIS (Foxglove). Hardy perennials of easy culture, valuable for shrubbery borders, woodland walks, partially shady places. Blooms in June and July. 3 to 4 ft.	
2535	gloxiniaeflora, Mixed. Fine colors, spotted in the throat 1/4 oz. 50c .15	
2540	grandiflora. Light yellow, fine. 1/4 oz. 35c .10	
2545	Ivery's Spotted. An extra choice strain of beautifully spotted flowers. 1/4 oz. 50c .10	
2548	Lutzii. Salmon hybrids. 4 ft. .. 1/8 oz. 50c .20	
2550	monstrosa, Mixed. Beautiful colors with one enormous flower at top of spike. 1/4 oz. 75c .15	
2553	The Shirley. Giant mixed..... 1/4 oz. 85c .20	
2555	purpurea, Mixed. All colors 1/4 oz. 40c .10	
2560	purpurea, Red 1/4 oz. 50c .15	
2565	purpurea, Rose 1/4 oz. 50c .15	
2570	purpurea, White 1/4 oz. 50c .15	

No.		Pkt.
2575	DIMORPHOTHECA aurantiaca (African Marguerite). Beautiful Transvaal annual, with a profusion of rich orange-gold flowers throughout the season. 15 in. 1/4 oz. 75c \$0.15	
2576	Eklonis. Pure white, blue center..... 1/8 oz. 60c .20	
2580	New Hybrids. Rich colors 1/4 oz. 75c .15	
2582	Salmon Beauty 1/8 oz. 60c .20	
	DOLICHOS (Hyacinth-bean). A beautiful, quick growing annual climber; the seed pods are quite ornamental. 10 ft.	
2585	Darkness. Rich, purple-violet Oz. 40c .10	
2590	Daylight. Snow white; excellent.. Oz. 40c .10	
2595	lablab, Mixed. Purple and white.. Oz. 30c .10	
2596	DORONICUM caucasicum. H. P. Early yellow, 2 ft.50	
2598	pardalianches (Bunch of Gold). H. P. 2 1/2 ft.. Long stemmed flowers of bright canary yellow, blooming in May and June.75	
	DRACAENA. Decorative plants, with long, graceful foliage; valuable for vases and house decoration; tender perennials.	
2605	indivisa. Narrow green foliage. 1/4 oz. 30c .10	
2610	Ornamental Foliage Sorts. Including the best and most brilliant colors..... .25	
2615	DRACOCEPHALUM moldavica. Fine hardy annual, with spikes of violet blue, Salvia-shaped flowers. 2 ft.10	
2620	ECHINACEA helianthus (Red Perennial Sunflower). Large, purplish red flowers freely produced through the whole summer. 5 ft.15	
2625	purpurea. Large purple, black disc. 3 ft... .15	
2630	ECHINOCYSTIS lobata (Wild Cucumber). Rapid growing annual climbers, with ornamental seed pods and large seed. Soak the seed in warm water over night and plant the eye down. 20 ft... Oz. 50c .10	



Dianthus deltoides.

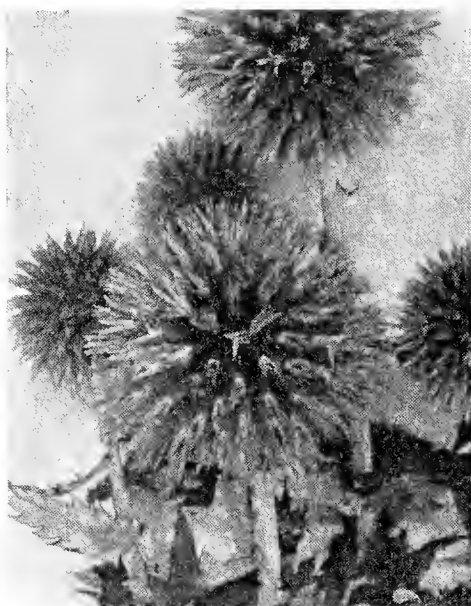

Echinops ritro.



Erigeron.



Eschscholtzia.

No.		Pkt.	No.		Pkt.
2633	ECHINOPS ritro (Globe Thistle). Blue thistle-like flowers, silvery-white foliage	\$0.15	2708	TANGO . Bronzy red overlaid terra cotta... ¼ oz. 50c	\$0.15
2634	ECHIUM plantagineum . Annual. 1½ feet. Purple-blue flowers with rosy tint. Fine for bees.25	2709	The Geisha . Fluted petals, orange-crimson	¼ oz. 50c .15
2635	EDELWEISS (Gnaphalium leontopodium). Charming Swiss Alpine plant, with lovely star-shaped, white everlasting flowers25	2710	Finest Mixed . All colors	Oz. 50c .10
	ERIGERON (Midsummer Daisy). Effective hardy perennial, May to Oct. 1½ ft.		2712	Ramona Strain Frilled Hybrids . A new, compact erect strain of fluted and frilled blossoms of many beautiful hues	Oz. \$1.00 15
2648	alpinus . Dwarf, free flowering with clusters of small purplish daisy-like flowers. Fine for rock gardens.25		EUPATORIUM . Free blooming, hardy perennials. Blooms first season from seed. Aug. to Oct.	
2650	aurantiacus hybridus . Shades of orange and yellow25	2715	ageratoides . Dense heads of small, white flowers. 4 ft.	¼ oz. 75c .10
2655	speciosus hybridus grandiflorus . Large mauve color; excellent for cutting.....	.15	2720	fraseri . Snow white. 2 ft.....	½ oz. 1.00 .25
2660	ERYNGIUM amethystinum . A handsome, hardy perennial, with beautiful foliage and flowers of a lovely blue. Can be dried for winter. July, Aug. 3 ft..... ¼ oz. \$1.00	.25	2725	EUPHORBIA heterophylla (Mexican Fire-plant). The beautiful orange-scarlet bracts completely cover the plant almost the entire season. Annual. 2 to 3 ft.	¼ oz. 50c .15
2665	ERYSIMUM, Golden Gem . Golden yellow hardy biennial, like a miniature Wall-flower, effective for Spring bedding. ¾ ft.	¼ oz. 85c .10	2730	variegata (Snow-on-the-mountain). Foliage striped and margined with white. Annual. 1½ to 2 ft.....	Oz. \$1.00 .10
	ESCHSCHOLTZIA (California Poppy). Pro-fuse flowering plants, with bright, showy flowers; excellent for bedding massing or ribbon work. Hardy annual June to Oct. 1 ft.		2735	EXACUM affine . Dwarf, showy, tender annual for pot culture with clusters of fragrant lilac flowers. 1 ft.....	.25
2668	Double Autumn Glory . Frilled, outside orange-crimson, inside coppery orange.	.15		FERNS . A well-known, graceful and attractive class of plants.	
2670	aurantiaca . Orange True California Poppy	Oz. 50c .10	2740	Greenhouse Varieties, Finest Mixed25
2675	california alba	Oz. 50c .10	2745	Hardy Varieties, Mixed . Finest sorts for outdoor growing25
2680	Carmine King . Deepest carmine..	Oz. 75c .10	2750	Adiantum cuneatum (Maidenhair Fern)..	.25
2685	crocea fl. pl. Double orange.....	Oz. 75c .10		FEVERFEW . See <i>Matricaria</i> .	
2690	Frilled Pink . Delicate pink	Oz. 75c .10		FORGET-ME-NOT . See <i>Myosotis</i> .	
2691	Golden Glory . Double Golden-yellow deepening to orange at the center20		FOUR O'CLOCK . See <i>Mirabilis</i> .	
2692	Golden West . Yellow, orange center.... Oz. 50c	.10		FOXGLOVE . See <i>Digitalis</i> .	
2695	Mandarin . Inside orange, outside scarlet.	Oz. 75c .10	2755	FRANCOA ramosa (Bridal Wreath). The long sprays of pure white flowers are largely used for table decoration. An excellent decorative greenhouse plant. 2½ ft.25
2705	Rose Cardinal . Creamy rose.....	Oz. 50c .10	2760	FREESIA, New Hybrids Mixed . Beautiful variety, with new colors and delicate shades, blooming in six to eight months.	.25

No.		Pkt.
2765	FUCHSIA, Double and Single Mixed. The raising of Fuchsias from seed is interesting, there always being the possibility of securing something new and distinct; the seed offered is saved from a choice collection	\$0.50
	GAILLARDIA (Blanketflower). Beautifully showy annuals, giving a profusion of brilliant flowers during the summer and autumn. Fine for cutting. 2 ft.	
2770	Single, Finest Mixed. All colors..Oz. 75c	.10
2775	Double, Finest Mixed ¼ oz. 50c	.10
2780	Indian Chief. Single bronze red. ¼ oz. 50c	.15
	GAILLARDIA. Perennial varieties. 2 to 3 ft.	
2783	Burgundy. Shining wine red flowers, 2½ in. across. Plants bushy, 2½ ft....	.25
2785	sanguinea. Large, deep crimson with golden margin ¼ oz. 60c	.15
2790	maxima. Large. pure yellow ... ¼ oz. 50	.15
2793	Portola hybrida (New). Bronzy red shades, golden tipped ½ oz. 50c	.25
2796	Tangerine. Orange-red25
2797	The Dazzler. Red, tipped gold.. ½ oz. 35c	.15
2800	Finest Hybrids ¼ oz. 50c	.15
2805	GAURA lindheimeri. Half hardy annual of graceful habit with numerous sprays of rosy white flowers throughout the summer. Fine for vases. 2 ft. ¼ oz. 50c	.15
2808	GAZANIA splendens hybrida grandiflora. 8 in. Half hardy perennial flowering first year. Plants spread close on the ground and produce brilliant orange, yellow and white daisy-like flowers marked with a black and silver zone at base of petals. Sunny location.35
2810	GENISTA canariensis (Broom). Handsome, half hardy perennials for room decoration, with bright yellow flowers. 2 ft...	.25
2815	andreaana. Crimson and yellow, handsome	.25
2820	GENTIANA acaulis (Alpine Blue Gentian). Dwarf early, spring-flowering Alpine perennial, with intense blue, bell-shaped flowers. 6 in. ¼ oz. 85c	.15
2825	lutea (Giant Gentian). Bright yellow flowers in whorls on stems. 4 ft high..	.15
	GERANIUM. Popular plants, easily raised from seed. Half hardy perennial.	
2830	Apple-scented. Fragrant foliage.....	.25
2835	Show Pelargoniums (Lady Washington). Newest large-flowered Show varieties.	.50
2840	zonale, Finest Mixed. Specially saved....	.15
2845	Double, Finest Mixed. Finest sorts.....	.50
2850	GERARDIA, New Hybrids. Spikes of handsome. Foxglove-like flowers; very free flowering perennials, blooming first season from seed and hardy in sheltered situations. July to September. 2 ft..... ½ oz. 25c	.10
2855	GERBERA jamesoni (Transvaal Daisy). Beautiful Daisy of a brilliant orange-vermillion color, on long stems, blooming almost the whole year if given greenhouse protection during winter..	.50
2860	jamesoni Hybrids. New hybrids of the preceding which are more hardy and easily grown. The colors are rich and delicate, with a wonderful range from pure white through orange, salmon, rose, cerise, to ruby red and violet.....	.50

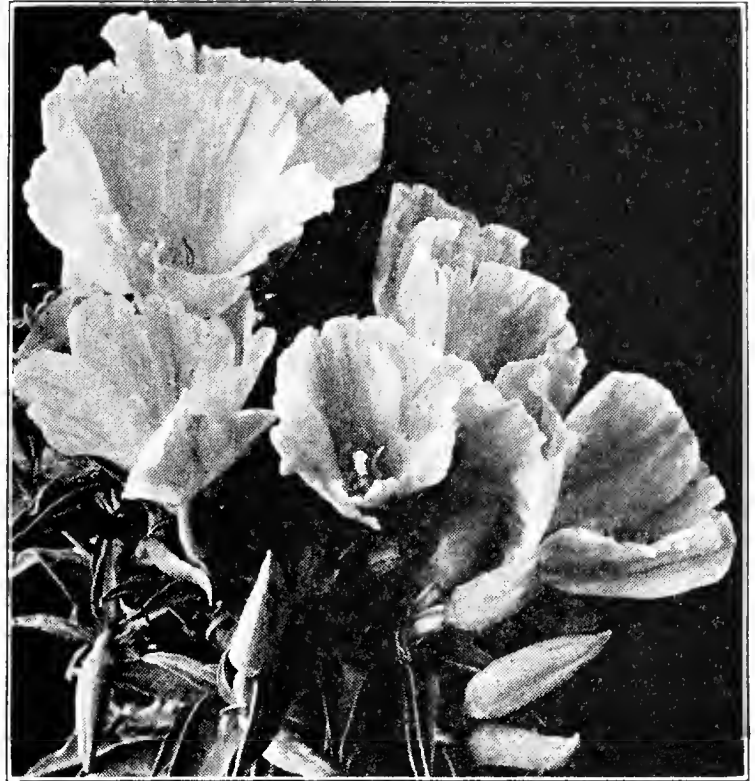

Godetia, (See page 20).

No.		Pkt.
2865	GESNERIA, Mixed Hybrids. Greenhouse bulbous plants with beautifully marked velvety foliage and handsome spikes of brilliantly colored flowers	\$0.50
	GEUM. Showy, hardy perennial of easy culture, and well adapted for the flower garden; fine for cutting. July to Oct. 2 ft.	
2875	coccineum. Bright scarlet ¼ oz. 30c	.10
2876	Mrs. Bradshaw. Double scarlet.....	.25
2877	Lady Stratheden. Beautiful orange.....	.25
2880	GILIA, Finest Mixed. Showy, hardy annual, blooming from early in the season until frost. 1 ft. ¼ oz. 30c	.10
2885	GLAUCUM flavum tricolor (Horned-poppy). Free flowering, hardy annuals. Handsome silvery foliage; orange-scarlet and black flowers in July. 2 ft. .. ¼ oz. 50c.	.15
	GLOBE-AMARANTH (Gomphrena). Showy annual everlasting; the flowers resemble clover heads, and when dried are used for winter decoration; fine for bedding. 1½ ft.	
2890	Purple ¼ oz. 25c	.10
2895	Orange ¼ oz. 25c	.10
2898	Rose ¼ oz. 25c	.10
2900	White ¼ oz. 25c	.10
2905	Mixed. All colors ¼ oz. 25c	.10
	GLOXINIA. The seed offered has been selected from the finest erect flowering varieties and will give blooms of finest quality. For a succession of flowers from seed, sowings should be made at intervals from January to May. A moist heat of from 65 to 70 degrees is best to start them in.	
2910	Grey's Invincible Prize. Has the reputation of being the finest strain grown; very free flowering, with large open flower in the greatest variety of colors.	1.00
2915	Giant Mixed. A prize strain with large flowers of richest colors50

No.		Pkt.	No.		Pkt.
	GOSETIA (Satin Flower). Handsome hardy annuals, blooming profusely from July to October. Large, wide open flowers of shining satiny texture, and of the most delicate and brilliant colors. 1½ ft.			HELIANTHUS (Sunflower). Well-known hardy annuals, the small flowering sorts being very useful for cutting, while the larger sorts are very ornamental and useful, blooming all summer.	
2920	Duchess of Albany. Satiny white		3060	Double Californian. Deep yellow. 5 ft.	
		¼ oz. 50c \$0.10		Oz. 50c \$0.10	
2925	Double Rosy Morn.	¼ oz. 75c .15	3065	Double Chrysanthemum flowered. Orange yellow, fine for cutting. 5 ft.	Oz. 60c .10
2930	gloriosa. Brilliant, blood red	¼ oz. 60c .10	3070	Dwarf. Orange. 3 ft.	Oz. 50c .10
2935	Lady Satin Rose. Rich rose-pink.	¼ oz. 75c .15	3075	globosus fistulosus. Large, globe shaped, rich orange color. 7 ft.	Oz. 30c .10
2937	Lavender. True color	¼ oz. 75c .15	3080	Single cucumerifolius (Miniature Sunflower). Small, bright yellow, with black center. 4 ft.	Oz. 75c .10
2938	Sweetheart. New Dwarf Double. Bright cream-pink	¼ oz. 75c .15	3090	cucumerifolius, Stella. Golden yellow. The largest miniature sort. 4 ft.	Oz. \$1.00 .10
2939	Sybil Sherwood. Bright salmon-pink.	¼ oz. \$1.00 .25	3095	giganteus uniflorus. One immense flower a foot or more across	Oz. 35c .10
2940	Mixed. Tall, double. Beautiful colors.	¼ oz. 35c .10	4000	Giant Russian. Large. 6 ft.	Oz. 20c .10
	GOURDS, Ornamental. Quick growing vines desirable for covering arbors, walls, etc., and producing useful and ornamental fruit in great variety of shapes and colors. Tender annual. 15 to 20 ft.		4002	Golden Fleece. Small Cactus flowers, golden yellow; dark center15
2945	Collection of 12 sorts	1.00	4005	Maroon Prince. Deep crimson, shading lighter toward the points.	¼ oz. 50c .15
2950	Angora. White spotted fruit	Oz. 40c .10	4010	Perennial Hybrids. The flowers vary in shades, size and form	¼ oz. \$1.00 .15
2955	Apple Shape. Striped fruit	Oz. 40c .10		HELICHRYSUM, Double Flowered. Pretty annual everlasting, blooming all summer; fine in mixed borders and useful as dried flowers for winter, for which purpose they should be gathered before fully open. 2 ft.	
2960	Bottle Shape. White and green.	Oz. 40c .10	4015	Mixed	¼ oz. 50c .10
2965	Dipper Shape	Oz. 40c .10	4016	Canary Yellow	¼ oz. 60c .15
2970	Dishcloth or Sponge	Oz. 40c .10	4017	Deep Crimson	¼ oz. 60c .15
2975	Egg Shape. Useful as nest eggs	Oz. 40c .10	4018	Salmon	¼ oz. 60c .15
2980	Gooseberry. Very small	Oz. 60c .10	4019	Golden Ball	¼ oz. 60c .15
2985	Hercules Club. 4 ft. long	Oz. 40c .10	4020	Rose Queen	¼ oz. 60c .15
2990	Orange Shape. Mock orange	Oz. 40c .10	4021	Silver Pink	¼ oz. 60c .15
2995	Pear Shape. Striped	Oz. 40c .10	4022	Violet	¼ oz. 60c .15
2998	Pipe Gourd (Calabash)	Oz. 40c .10	4023	White	¼ oz. 60c .15
3000	Serpent Shape. 4 to 5 ft. long.	Oz. 40c .10	4024	HELIOPHILA leptophylla. 9 in. Excellent annual for border. Flowers ½ in across, bright blue with white eye.25
3005	Sugar Trough	Oz. 40c .10			
3008	Turk's Turban. Small, bright red.	Oz. 40c .10			
3010	Mixed Sorts. In great variety	Oz. 30c .10			
	GRASS, Ornamental. See page 40.				
3015	GREVILLEA robusta (Silk-oak). Beautiful evergreen, with fern-like foliage, magnificent for decorative purposes, and well adapted for house culture. Tender perennial.	¼ oz. 50c, oz. \$1.75 .15			
	GYPSOPHILA (Babysbreath). Extremely light and graceful, hardy plants of easy growth, flowering from June to Sept. Useful for cutting to mix with other flowers.				
3020	elegans alba grandiflora. Large, white, annual	¼ oz. 15c, oz. 50c .10			
3022	elegans carminea.	¼ oz. 15c .10			
3025	elegans rosea. Rose-pink, annual.	Oz. 50c .10			
3028	pacifica. Hardy perennial. New pink, blooming after the paniculata variety.20			
3030	paniculata. Pure white, hardy.	¼ oz. 50c .10			
3035	fl. pl. Double, white, hardy. This variety produces about 60 per cent of double flowering plants.25			
	HELENIUM. A most valuable hardy perennial, fine for cutting, as it gives an enormous crop of flowers in the late summer and autumn. 5 ft.				
3045	autumnale superbum. Golden; fine25			
3050	bigelowi. Golden yellow, with black center15			
3054	Riverton Gem. Old gold changing to wallflower red. 3 ft.25			
3055	HELIANTHEMUM mutabile. Dwarf hardy perennial, with brilliant flowers of various colors; very profuse in bloom and suited for dry soil and rockeries. June to Sept. 6 in.	¼ oz. 60c .15			



Helenium.

No.		Pkt.
	HELIOTROPE. A universal favorite on account of its delicious fragrance; excellent for cutting. H. H. P.	
4025	Grey's Giant Dwarf. Splendid strain of low, compact growth 1/8 oz. 85c	\$0.25
4030	Giant Hybrids. Mammoth 1/8 oz. 85c	.25
4035	Mixed Dark Blue Shades 1/8 oz. 50c	.15
	HESPERIS matronalis (Sweet Rocket). Fragrant spring flowering hardy perennial, growing freely in ordinary soils.	
4045	Dwarf Pure White. Early. 1 ft., 1/4 oz. 50c	.15
4050	Pure White. 3 ft. Oz. \$1.50	.10
4055	Purple. 3 ft. Oz. 1.50	.10
4060	Mixed. Purple and white Oz. 1.00	.10
4064	HEUCHERA. Choice Hybrids. Dwarf hardy perennials. Spikes of numerous small bell-shaped flowers, well above the foliage. 1 ft25
4065	sanguinea splendens. Brilliant crimson.25
	HIBISCUS. A showy class of plants suitable for mixed beds or borders, with large and beautifully colored flowers. Free flowering. Hardy perennials, unless noted.	
4070	africanus. Buff, with maroon center. Hardy annual, July to October. 2 ft. 1/4 oz. 35c	.10
4075	Crimson Eye. Large, pure white, crimson center, July to Sept. 4 ft. 1/4 oz 50c	.15
4078	Giant Red. 1/4 oz. 50c	.15
4080	moscheutos, Rose. Large, light rose. July to Oct. 4 ft. 1/4 oz. 50c, oz. \$1.50	.15
4085	moscheutos, White. Large, pure white. July to Oct. 4 ft. 1/4 oz. 50c, oz. \$1.50	.15
4087	moscheutos Hybrids. 1/4 oz. 50c, oz. \$1.50	.15

No.		Pkt.
	HOLLYHOCK. One of the oldest garden favorites and finest of our autumn flowers. Seed sown in February and potted on will bloom the same season, and July sown seed the next season. They require a well-drained, deep, rich soil. Hardy biennial.	
4095	Collection of 6 Double Varieties.	\$1.00
5000	Double Superb Mixed. An improved strain 1/4 oz. 75c, oz. \$2.75	.20
5002	Colorado Sunset. Copper to cream 1/4 oz. 75c, oz. \$2.75	.20
5005	Crimson 1/4 oz. 75c, oz. \$2.75	.20
5006	Exquisite. A large, double fringed Hollyhock in a variety of colors with margined and blotched petals25
5007	Imperator. Mixed. Flowers 5 or 6 in. across, fringed, with rosette centers.35
5007A	Lilac Beauty 1/4 oz. 75c, oz. \$2.75	.20
5007B	Maroon 1/4 oz. 75c, oz. \$2.75	.20
5008	Newport Pink 1/4 oz. 75c, oz. \$2.75	.20
5010	Orange Prince25
5012	Purple 1/4 oz. 75c, oz. \$2.75	.20
5015	Rose Pink 1/4 oz. 75c, oz. \$2.75	.20
5020	Royal Scarlet 1/4 oz. 75c, oz. \$2.75	.20
5025	Snow White 1/4 oz. 75c, oz. \$2.75	.20
5030	Yellow 1/4 oz. 75c, oz. \$2.75	.20
5035	Single Mixed 1/4 oz. 50c	.15
5036	Maroon 1/4 oz. 50c	.15
5038	Mauve 1/4 oz. 50c	.15
5039	Pink 1/4 oz. 50c	.15
5040	Rose 1/4 oz. 50c	.15
5041	Scarlet 1/4 oz. 50c	.15
5042	White 1/4 oz. 50c	.15
5043	Yellow 1/4 oz. 50c	.15
5044	Collection, 6 Single Varieties75
	EVERBLOOMING HYBRIDS (Annual). Beautiful flowers in all colors and shades, blooming the first season.	
5045	Double Mixed 1/4 oz. 75c	.15
5050	Single Mixed 1/4 oz. 60c	.15
5055	HONESTY, Mixed (<i>Lunaria biennis</i>). The seed pods, which are flat and broad, look like transparent silver and are much prized for winter decoration. 2 ft. 1/4 oz. 50c	.10
	HUMULUS (Hop). Rapid growing climbers, with handsome foliage. 15 to 20 ft.	
5060	japonicus. Green foliage, H. A. 1/4 oz. 30c	.10
5065	variegatus. Variegated foliage. 1/4 oz. 30c	.10
5070	lupulus. Hardy perennial 1/4 oz. 40c	.10
5075	HUNNEMANNIA fumaraeifolia (Giant Yellow Tulip Poppy). Perennial. Flowers throughout the season. Blooms in three months from seed. 2 ft. 1/4 oz. 50c	.10
5078	Sunlite. Double perennial poppy with extra band of petals outside, giving the impression of an open flower at all times. Color, canary-yellow, foliage light gray-green. 2 ft.20
	IBERIS (Hardy Candytuft). Free flowering compact perennials, making a beautiful display early in the season; suitable for rockeries and borders. 1 ft.	
5080	gibraltarica. Very large flowers of a delicate lilac color 1/4 oz. \$1.50	.15
5083	Queen of Italy. Rosy lilac 1/4 oz. 50c	.15
5085	sempervirens. The evergreen Candytuft with glossy, deep green foliage and white flowers 1/4 oz. \$1.75	.15
	Annual Varieties. See Candytuft.	



Double Hollyhocks.

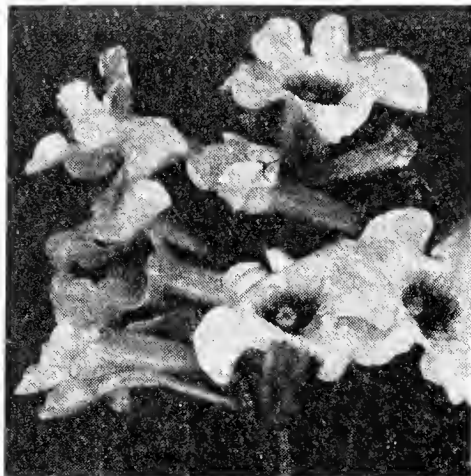

Incarvillea.



Kochia.

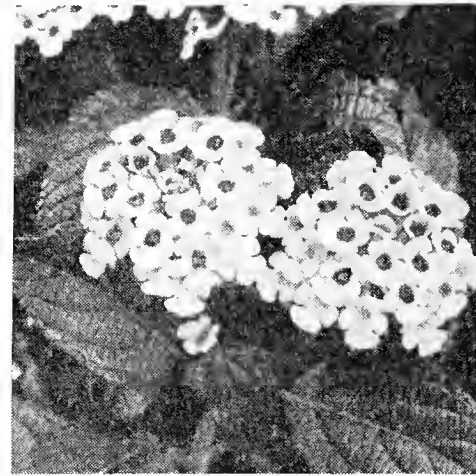

Lantana.

No.		Pkt.
5090	ICE PLANT. Half-hardy annual with leaves and stems thickly covered with sparkling ice-like globules. Fine for vases and piazza boxes, also for garnishing. Flowers white, 6 in. ¼ oz. 25c \$0.10	
	IMPATIENS (Sultan's or Zanzibar Balsam). A very fine, tender perennial for pot culture in the house or greenhouse and very useful for summer bedding, as they are in bloom continually.	
5095	holsti. Large, brilliant vermilion. 1½ ft.50
5100	holsti Hybrids. Choice colors of these large flowered new sorts. 1½ ft.35
5105	sultani. Large, rich bright rose. 1 ft.25
5110	INCARVILLEA delavayi. Fine half hardy tuberous-rooted perennial, with large bright rose-colored, bell-shaped flowers in clusters. The tubers can be taken up and stored through the winter. 2½ ft.25
5115	INULA glandulosa grandiflora. Very bold and handsome hardy perennial, large orange-yellow flowers. 2 ft.25
	IPOMOEA. Splendid rapid growing climbers, with large, bright colored flowers; they are exceedingly pretty when grown among other climbers. Hardy annual. 15 ft.	
5120	purpurea, Finest Mixed (Morning-glory, Convolvulus major)...Oz. 25c, ¼ lb. 75c	.10
5125	purpurea, Double MixedOz. 50c	.10
5130	coccinea (Star Ipomoea). Scarlet, star-shaped flowers in profusion....Oz. 60c	.10
5135	Heavenly Blue. Early flowering. Immense beautiful flowers of bright sky blue; seed should not be sown outside till ground is warm.¼ oz. 75c	.15
5140	imperialis japonica (Japanese Giant). Most beautiful strain, with immense flowers of finest colors and markings Oz. 60c	.10
5145	noctiflora hybrida (Moonflower). Large, fragrant, white flowers.....Oz. \$1.00	.10
5148	Rose Marie. New, double deep rose.....	.25
5150	setosa. Enormous leaves and large rose-colored flowers in clusters....Oz. 75c	.10
	quamoclit (Cypress Vine). Finely cut fern-like foliage and masses of brilliant, star-shaped flowers.	
5155	Bright ScarletOz. \$1.00	.10
5160	Pure WhiteOz. 1.00	.10
5165	Mixed. Scarlet, white and pink. Oz. 1.00	.10

No.		Pkt.
5170	hybrida (Cardinal Climber). Large, brilliant cardinal-red flowers in clusters, all summer	\$0.25
5175	IRIS, Mixed Varieties. All sorts and colors of this beautiful spring and summer blooming hardy perennial..... ¼ oz. 75c	.10
	JACOBS-LADDER. See Polemonium.	
	KENILWORTH IVY. See Linaria cymbalaria.	
5180	KOCHIA trichophylla (Mock Cypress, or Belvedere). A pretty half-hardy annual forming compact bushes about 2½ ft. high, with small, feathery, light green foliage which changes to a crimson hue in September¼ oz. 25c	.10
5182	KUDZU VINE. Easily grown from seed. Attains a length of 40-50 ft. from established roots. Flowers purple, pea-shaped, and borne in clusters late in the season. Foliage large and lobed....	.15
	LANTANA. Most elegant and showy bedding plants of as easy culture as Verbena or Geranium; flowers freely produced in beautiful clusters, and constantly changing in hue.	
5185	New Dwarf Bedding Hybrids. 1 ft.....	.25
5190	Tall Hybrids. 2 ft.¼ oz. 50c	.15
	LARKSPUR. See Delphinium.	
	LATHYRUS latifolius (Perennial Pea). Handsome, free-flowering, hardy perennial climber of great beauty, with clusters of elegant, Sweet Pea-like flowers in great profusion; useful as a cut flower. 6 ft.	
5195	albus. Pure white, very desirable., ¼ oz. 75c	.15
5200	Pink Beauty. Bright rosy pink. ¼ oz. 75c	.15
5205	splendens. Rich crimson¼ oz. 75c	.15
5210	Mixed. All colors ...¼ oz. 40c, oz. \$1.25	.10
	LAVATERA (Bar Harbor Marsh Mallow). Large flowered variety, hardy annual, allied to the Mallows, covered during the entire summer with its pretty and showy blossoms. 3 ft.	
5215	splendens. Rose¼ oz. 50c	.15
5218	splendens, Sunset. Rosy Carmine ¼ oz. 50c	.15
5220	splendens. White¼ oz. 50c	.15
5225	LAVANDULA vera (Sweet Lavender). Chiefly cultivated for the delicious and lasting fragrance of its flowers. Hardy perennial. July to September. 2 ft. Oz. \$1.00	.15

No.		Pkt.	No.		Pkt.
5230	LEPTOSYNE maritima. Free flowering hardy annual, large single yellow Coropsis-like flowers on long stems; fine for cut flowers. Aug. to Oct. 2 ft. ¼ oz. \$1.00	\$0.15	5280	hybrida, Sapphire. Deep sapphire blue, white eye. Fine for hanging baskets...	\$0.25
5232	Stillmani. A dwarf early flowering sort, fine for borders and for forcing in the greenhouse. 18 in.25	5285	speciosa (Crystal Palace). Spreading habit, with dark blue flowers ¼ oz.	85c .15
5234	LIATRIS pycnostachya. Purple, 4 ft. August to October. Hardy perennial.25	5290	White Lady. Compact, large flowered, pure white ¼ oz.	60c .10
5235	spicata. (Blazing Star). Desirable hardy perennial. The brilliant rosy purple flowers are on long spikes and freely produced. July to September. 2 ft.15	5295	ramosa (Erect growing). Rich blue, large flowered. 9 in. ½ oz.	50c .25
5240	LILIUM regale (Royal Lily).....	.50	5300	alba. Large white ½ oz.	50c .25
	LINARIA (Toadflax). Annual. 1 ft.		5305	Heavenly Blue. Large, clear blue ¾ oz.	50c .25
5241	Fairy Bouquet. Dwarf, Compact, large, bright flowers in mixed colors.25	5310	rosea. Large, deep rose ½ oz.	50c .25
5243	maroccana, Excelsior Mixed15	5315	LOPHOSPERMUM scandens. Beautiful half hardy climber, suited for baskets and vases. Bright pink ¼ oz.	60c .15
5243A	maroccana. Snow white.15		LUPINUS (Lupines). Old-fashioned and well-known annuals, very free growing, with long spikes of bright colored, pea-shaped flowers, and useful in a cut state. 2½ to 3 ft.	
5245	cymbalaria (Kenilworth Ivy). Beautiful, trailing plants for baskets or rock work15	5320	cruckshanki. Dark blue; fine....Oz.	50c .10
	LINUM. A valuable class of plants flowering for months and worthy of extended cultivation in masses or clumps in mixed borders. 1½ ft.		5325	hartwegi albus. White.....Oz.	\$1.00 .10
5250	grandiflorum rubrum. Brilliant scarlet, profuse flowering annual.Oz.	75c .10	5330	Cambridge Blue. Sky blue....Oz.	\$1.00 .10
5254	perenne, Blue. June-Aug. Fine for borders	.25	5332	King Blue. 3-4 ft. Enormous spikes of rich Oxford blue flowers with a white stripe. Excellent for cut flowers and for forcing under glass.....	¾ oz. 75c .20
5255	Mixed Perennial Sorts. Fine ..¼ oz.	50c .10	5333	King White. Glistening pure white, a companion to King Blue. Exquisitely scented. ¼ oz.	75c .20
	LOBELIA Most useful plants, free flowering and of easy culture. For bedding, edging, vases, etc. Treated as annuals, except the Cardinal varieties.		5335	Oxford Blue. Rich dark blue. .Oz.	\$1.00 .10
5260	cardinalis. Brilliant scarlet; hardy. 3 ft.	.25	5340	roseus. Fine rose-pinkOz.	\$1.00 .10
5265	grandiflora. Flowers double the size of the old sorts; hardy. 3 ft.25	5342	luteus romulus. Large yellow, 1 ft. ¼ oz.	50c .20
5266	Blue Stone Erinus. Compact, clear blue without eye, best for bedding.25	5345	mutabilis. White, sweet scented. Oz.	50c .10
5267	Blue Wings. A splendid dwarf blue variety; large flowers25	5350	roseus hybridus.Oz.	\$1.50 .10
5268	Cambridge Blue. Light blue, large flowered, green foliage, compact25	5355	Mixed Annual Sorts. All colors. Oz.	50c .10
5270	Crystal Palace compacta. Extra select dark blue; fine edgings. .. ¼ oz.	\$1.00 .15		LUPINUS (Lupines). Perennial Varieties. Handsome hardy perennials with immense spikes of pea shaped flowers. 3 ft.	
5275	gracilis. Spreading habit, with bright blue flowers.¼ oz.	75c .15	5360	polyphyllus, Blue	Oz. 75c .10
			5362	Elliott's Sweet Scented. Mixed colors..	.20
			5363	Lavender Queen15
			5364	luteus. Yellow.20
			5365	moerheimi. Rose and white...Oz.	\$2.50 .25
			5370	roseus. Pink shades	Oz. \$1.50 .15
			5375	White	Oz. 75c .10
			5380	Mixed	Oz. 75c .10
			5385	Excelsior Mixed. New shades.. Oz.	\$1.25 .15



Lobelia, Crystal Palace.



Linum perenne.



Lychnis chalcidonica.

No.		Pkt.
	LYCHNIS. Hardy perennials with large terminal trusses of very showy flowers.	
5390	<i>chalcedonica.</i> Scarlet. 3 ft. ¼ oz.	50c \$0.10
5395	<i>alba.</i> White. 3 ft. ¼ oz.	50c .10
5400	<i>viscaria splendens.</i> Deep red. 16 in. ¼ oz.	60c .10
5405	<i>haageana hybrida.</i> 18 in. ¼ oz.	85c .15
5410	LYTHRUM roseum superbum. Vigorous perennial with spikes of bright rose colored flowers. 3 ft.15
	MALOPE. Free blooming, hardy annuals, with large, handsome, mallow-like flowers. July to Oct. 3 ft.	
5415	<i>grandiflora alba.</i> White.....Oz.	75c .15
5420	<i>grandiflora rosea.</i> Rose-pinkOz.	75c .15
	MALVA or MALLOW. Free flowering, hardy perennials. Sown early, will bloom first season.	
5425	<i>alcea.</i> Pink; blooms all summer. ¼ oz.	85c .15
5430	<i>moschata</i> (Muskmallow). Clusters of fragrant rose-colored flowers .. ¼ oz.	50c .15
5435	<i>alba.</i> White, fragrant. 2½ ft. .. ¼ oz.	50c .15
	MARIGOLD, Double African. Handsome hardy annuals, with rich and showy flowers throughout the season. 3 ft.	
5445	Grey's Selected Orange Prince25
5450	Grey's Selected Lemon Queen25
	Above two sorts specially grown for us by a Scotch specialist and are without an equal.	
5455	Collection of 6 varieties, separate50
5456	All double Lemon. Tall large flowers15
5458	All double Orange. Tall large flowers15
5460	Lemon. Ball. Extra ¼ oz.	40c .10
5465	Orange. Ball. Extra ¼ oz.	40c .10
5470	Pride of the Garden. Deep yellow quilled. 1½ ft. ¼ oz.	40c .10
5472	Primrose Queen. Very large quilled.15
5475	El Dorado Mixture. Finest large-flowered sorts	¼ oz. 50c .15
5480	Dwarf Double Queen Strain Mixed. Flowers 2-3 in. across with rather flat petals15
	MARIGOLD, French, Double. These are the small velvety flowered sorts. 1 ft.	
5485	Collection of 6 varieties, separate50
5486	Dark Brown ¼ oz.	40c .10
5488	Dark Maroon. (Robert Beist) ¼ oz.	40c .10
5490	Gold Striped. ¼ oz.	40c .10
5491	Golden Ball ¼ oz.	40c .10
5493	Electric Light. Yellow blotched brown. ¼ oz.	40c .10
5494	Pallida. Sulphur-yellow ¼ oz.	40c .10
5495	Pulchra. Spotted ¼ oz.	40c .10
5500	Double Mixed. 1 ft. ¼ oz.	40c .10
5502	Dwarf Monarch Strain. Very compact, large, tight double flowers in wide color range. ¼ oz.	50c .15
5504	Tall French, Double Royal Scot. 2-2½ ft. The large, well formed flowers are a striking combination of mahogany and gold stripes radiating from the center ½ oz.	40c .15
5505	Scotch Prize. Special Scotch strain, from double striped prize flowers only. 2½ ft. ¼ oz.	\$2.50 .25
5510	Tall Double Mixed. 2½ ft. .. ¼ oz.	50c .10
5512	Tall Single French Josephine. 3 ft. Brown with fine gold edge10
5514	Dwarf Single French, Fire Cross. Saffron-orange with brown-red center.15



All Double Marigold.

No.		Pkt.
5515	Legion of Honor (Little Brownie). Single golden yellow, with a large spot of crimson velvet. 1 ft. ¼ oz.	50c \$0.15
5520	signata pumila (Tagetes). Single orange-yellow. 1 ft. ¼ oz.	50c .10
5522	Star of India. Single crimson striped yellow ¼ oz.	60c .15
5525	MATTHIOLA bicornis (Night-scented Stock). Delightfully fragrant towards evening. Hardy annual, with purplish red flowers. 1 ft. ¼ oz.	50c .10
	MATRICARIA (Feverfew). Free flowering annuals, useful for groups, borders and pot culture; also fine for cut flowers.	
5528	<i>capensis alba plenissima.</i> 2 ft. ¼ oz.	50c .15
5530	Dwarf Double Snowball	⅛ oz. 40c .15
5535	Dwarf Double Golden Ball. Quilled petals. ⅛ oz.	40c .15
5540	MAURANDIA, Finest Mixed. Elegant twining plants, with purple, rose and white flowers. Splendid for hanging baskets, window boxes, etc. ⅛ oz.	75c .10
5541	<i>barclayana.</i> Blue.25
5542	MECONOPSIS baileyi. Perennial sky blue. (Thibetan Poppy).50
	MESEMBRYANTHEMUM. Dwarf growing annuals of great beauty; excellent for rockeries, edgings, vases, etc. 6 in.	
5545	tricolor Mixed. ¼ oz.	50c .15
5550	cordifolium variegatum. Handsome foliage and bright rose colored flowers. ..	.25
5552	crinifolium (Livingstone Daisy). Annual. Small flowers of various colors. 3-4 in. high. Ideal for carpeting and rockeries.25
	crystallinum. See Ice Plant.	
	MIGNONETTE (Reseda). The most popular and favorite annual for garden and house culture, producing quantities of deliciously fragrant spikes of flowers.	
5555	Improved Eclipse. The immense, fragrant spikes of flowers 10 to 15 in. long, are produced in the greatest profusion. A superior variety for winter blooming, exhibition or cutting 1/16 oz.	\$2.00 .50
5560	Defiance. Very fragrant, large spikes, with individual florets of immense size..... ¼ oz.	40c, oz. \$1.25 .10

No.		Pkt.
5565	Giant Pyramidal. Large, fragrant spikes of reddish flowers. ... ¼ oz. 25c, oz. 75c	\$0.10
5570	Machet Improved. Dense spikes of very fragrant, dark red flowers; fine for pot culture ¼ oz. 50c, oz. \$1.50	.15
5575	Machet, Golden. Long, massive spikes with fragrant, golden-yellow flowers... ¼ oz. 25c, oz. 75c	.10
5580	Machet, White Pearl. Long spikes of fragrant white flowers ¼ oz. 50c.	.10
5590	odorata. The old-fashioned common sweet-scented sort Oz. 35c, ¼ lb. \$1.00	.10
5595	MIMOSA pudica (Sensitive plant). A tender annual of light and elegant growth, the leaflets of which fold up when touched; the pale, purplish flowers are produced at the axils of the leaves. 2 ft. ¼ oz. 50c	.15
MIMULUS. Showy, half-hardy annuals, with handsome flowers; excellent for pots or garden.		
5600	cardinalis grandiflorus. Large, bright scarlet. 2 ft.15
5605	tigrinus grandiflorus. Large - flowered, tigered and spotted varieties. 1½ ft....	.15
5610	Musk (Moschatus). Well known, popular plant, with fragrant, yellow flowers and foliage ½ oz. 85c	.25
5615	MINA lobata. A rapid growing annual climber bearing profusely racemes of orange-red flowers; prefer a warm situation.... ¼ oz. 85c	.15
MIRABILIS (Marvel of Peru, or Four-o'clock) Well known annuals, with most brilliant flowers of various colors, suitable for beds or borders. 2 ft.		
5620	Mixed. Brilliant colorsOz. 35c	.10
5625	Variegated Foliage, Mixed. All colors, with green and white leaves... Oz. 35c	.10
MOMORDICA. Ornamental, climbing annual, with handsome fruit which, when ripe, bursts open, exposing its bright red seeds and carmine interior.		
5630	balsamina (Balsam-apple). Apple-shaped fruit. 10 ft.Oz. \$1.00	.10
5635	charantia (Balsam-pear). Pear-shaped fruit. 10 ft.Oz. \$1.00	.10
MOONFLOWER. See <i>Ipomoea</i> .		
MORNING GLORY. See <i>Ipomoea purpurea</i> .		
MOURNING BRIDE. See <i>Scabiosa</i> .		
MOUNTAIN FRINGE. See <i>Adlumia</i> .		
5640	MUSA ensete (Abyssinian Banana). A splendid, large-leaved, palm-like plant, suitable for open air in summer, and producing a striking effect; seedlings attain a very large size the first season; tender perennial...100 seeds \$2.50	.25
MUSK PLANT. See <i>Mimulus</i> .		
MYOSOTIS (Forget-me-not). These beautiful half-hardy perennials bloom the first season and succeed best in moist, shady situations. If sown in frames in July or August, fine plants may be had for spring blooming. Fine for edging or in beds with Pansies, Daisies, etc.		
5645	Alpestris robusta grandiflora. Large, bright blue clusters. 1 ft. .. ¼ oz. \$1.00	.15
5650	Indigo or Royal Blue. Rich. ¼ oz. \$2.00	.25
5653	Indigo compacta. Very dwarf. ¼ oz. \$2.50	.25
5655	Victoria. Rich, bright blue, of dwarf, globular habit. ¼ oz. \$2.50	.20



Myosotis palustris.

No.		Pkt.
5660	Victoria rosea. Fine pink. ... ¼ oz. \$2.50	\$0.20
5670	dissitiflora Perfection. Bright blue flowers on long stalks last a long time, and are most suitable for table decoration at Christmas. Sow in June for winter blooming. The finest of all. 1 ft. ¼ oz. \$2.00	.25
5675	Palustris semperflorens (True Water Forget-me-not). Large, azure blue flowers. Blooms all summer ¼ oz. \$2.50	.25
5680	Ruth Fischer. Azure blue. The largest flowered variety25
5685	Stricta grandiflora. Upright, pillar-like habit; bright blue; very striking..... ¼ oz. \$1.50	.15
5690	Special Mixture. All colors... ¼ oz. \$1.00	.15
NASTURTIUM, Dwarf, or Tom Thumb varieties. Splendid for marginal lines to borders and indispensable summer bedding plants. They succeed best and flower better in poor soil and remain longer in bloom than perhaps any other annual. 1 ft.		
Oz. 25c, ¼ lb. 75c, 1 lb. \$2.50, unless priced.		
5695	Collection of 12 colors. Our selection....	\$1.00
5700	Columbia Mixture. Our own mixture which we make up from separate and distinct sorts; is without an equal....	.10
5705	Aurora. Primrose, striped with carmine..	.10
5710	Bronze. Bronzy orange.....	.10
5715	Beauty. Light scarlet.....	.10
5720	Chameleon. Straw color, flaked and veined red10
5725	Coerulea rosea. Rose, blue tinge.....	.10
5730	Crystal Palace Gem. Buff, spotted.....	.10

No.		Pkt.
NASTURTITIUM—Continued.		
5735	Dark Crimson. Fine, deep color.	\$0.10
5740	Empress of India. Deep, brilliant crimson, dark foliage10
5745	Golden King. Rich, golden yellow.....	.10
5750	King Theodore. Maroon, dark foliage....	.10
5755	King of Tom Thumb. Rich scarlet, dark foliage10
5760	Lady Bird. Yellow, barred with ruby....	.10
5765	Pearl. Pearly white.10
5770	Prince Henry. Yellow, scarlet spots.....	.10
5775	Rose. Soft carmine-rose.....	.10
5780	Ruby King. Rich ruby red, dark foliage..	.10
5785	Scarlet. Very brilliant. Gold leaved.10
5790	Spotted King. Yellow, spotted maroon, dark foliage.....	.10
5795	Vesuvius. Brilliant salmon-pink, dark foliage10
5800	Ivy-leaved, Mixed. Ivy-like foliage and attractive fringed flowers.....	.10
	Oz. 25c, ¼ lb. 75c	
5805	Variegated-leaved, Mixed. Beautifully variegated foliage ...Oz. 25c, ¼ oz. 75c	.10
5810	NASTURTITIUM, Lilliput, Finest Mixed. A distinct and fine flowering class, with its small compact bushes and immense numbers of small blooms displayed well above the foliage.....Oz. 35c	.10
NASTURTITIUM, Tall or Running Varieties.		
These are the large free flowering climbers for verandas, trellises and covering unsightly places. Seed pods picked when green and tender are used for pickling.		
Oz. 25c, ¼ lb. 75c, lb. \$2.25, unless priced.		
5815	Collection of 12 colors. Our selection.....	1.00
5820	Columbia Mixture. Our own mixture, which we make up from separate and distinct sorts, is without an equal.....	.10
5825	Bright Rose10
5830	Chameleon. Varying in color.....	.10
5835	Coccineum. Bright scarlet.....	.10
5840	Dark Crimson10
5845	Dunnett's Orange. Orange-red10
5850	Edward Otto. Brownish lilac.....	.10
5855	Fashion. Pure ecru, veined with old rose.10
5858	Gold Garnet. Orange-yellow, spotted garnet10
5865	King Theodore. Very deep maroon.....	.10
5870	Luteum. Fine yellow.....	.10
5875	Moonlight. Giant pale straw.....	.10
5880	Pearl. Almost white.....	.10
5885	Regelianum. Violet-ruby10
5892	Shillingi. Yellow spotted maroon.....	.10
5895	Sunlight. Giant, rich golden.....	.10
5900	Twilight. Light salmon, suffused with rosy salmon10
5905	Vesuvius. Rich apricot, dark foliage....	.10
5910	Von Moltke. Dark rose10
5915	Ivy-leaved, Mixed. Ivy-like foliage and fringed flowers in variety.10
	Oz. 25c, ¼ lb. 75c	
5920	Variegated-leaved, Mixed. An exceedingly fine acquisition ...Oz. 25c, ¼ lb. 75c	.10

No.		Pkt.
NASTURTITIUM, lobbianum Varieties. These differ from the tall Nasturtiums in being more free flowering, richer and brighter in color, and with darker foliage, and are superior for house or conservatory, also vases, baskets, etc. Are a mass of color from early summer until frost.		
5925	Asa Gray. Almost white	Oz. 25c \$0.10
5930	Black Prince. Velvety black.....	Oz. 35c .10
5945	Crown Prince. Deep blood-red....	Oz. 25c .10
5947	Firefly. Yellow, scarlet spotted... Oz. 25c	.10
5950	Golden Queen. Clear golden.....	Oz. 25c .10
5952	Lucifer. Glowing red, dark leaved. Oz. 25c	.10
5955	Margaret. Straw, crimson spot... Oz. 25c	.10
5965	Napoleon III. Golden brown spot.Oz. 25c	.10
5970	Primrose. Cream brown spots....	Oz. 25c .10
5975	Regina. Beautiful salmon.....	Oz. 25c .10
5978	Roi des Noirs. Black-brown.....	Oz. 25c .10
5980	Rudolf Virchow. Ruby-rose	Oz. 25c .10
5985	Spitfire. Bright scarlet; splendid. Oz. 25c	.10
5990	Mixed. All colors.....	Oz. 20c, ¼ lb. 60c .10
5995	Madame Gunther Hybrids. Dark foliage hybrids	Oz. 25c .10
6000	NEMESIA strumosa suttoni, Improved Mixed. A valuable long-blooming annual25
6001	Blue Gem, strumosa nana compacta. 8 in.	.25
6002	Fire King, strumosa nana compacta. 8 in.	.25
6003	Orange Prince, strumosa nana compacta. 8 in.25
6003A	Rose, strumosa grandif. suttoni25
6004	White Gem, strumosa nana compacta. 8 in.25
NEMOPHILA. Splendid, showy hardy annual for beds or edgings; beautiful decorative plants in pots for spring flowering in house or conservatory. 1 ft.		
6005	insignis. Bright blue, white center	¼ oz. 20c \$0.10
6010	Mixed. All shades	¼ oz. 20c .10

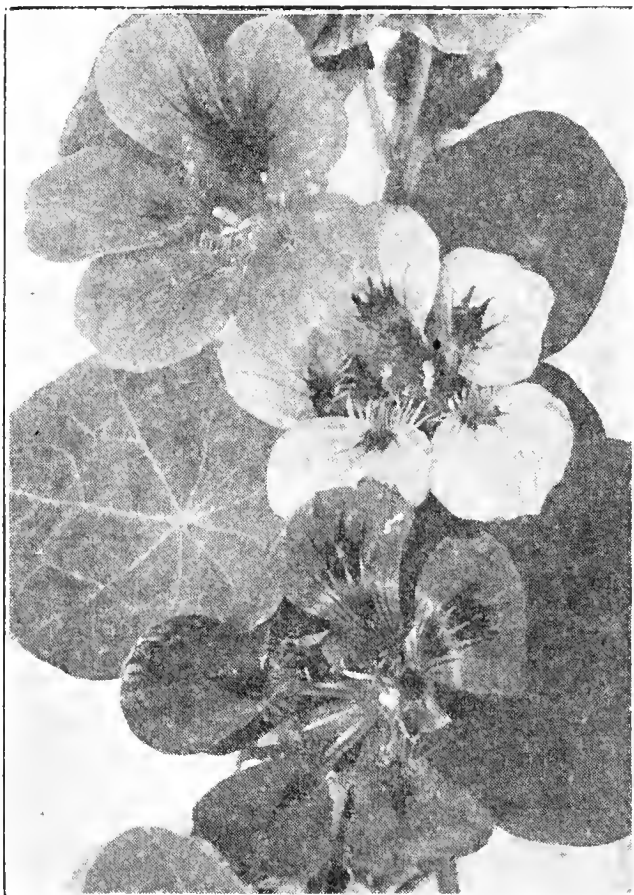

Columbia Mixture Nasturtiums.



Nicotiana.

- No. Pkt.
- NICOTIANA.** Very effective annuals; in bloom throughout the season, and produce their fragrant, tubular-shaped flowers in great profusion; excellent for cutting.
- 6015 **affinis.** White; fragrant; 3 ft... ¼ oz. 35c \$0.10
- 6020 **Choice Hybrids.** A great variety of bright colors: fragrant ... ¼ oz. 60c .10
- 6022 **Crimson Bedder.** Dwarf, pyramidal rich deep crimson, 15 in.25
- 6025 **colossea.** Giant foliage plant of a dark glossy green, with reddish ribs. 5 to 6 ft.25
- 6028 **hybrida, Pink Shades** ¼ oz. 40c .10
- 6030 **sanderae.** Brilliant carmine red. ¼ oz. 50c .10
- 6032 **suaveolens.** Small flowered species, pure white, delightfully scented. 1½ ft .. .25
- 6035 **sylvestris.** Pure white. 4 ft.... ¼ oz. 50c .10
- NIEREMBERGIA.** Graceful, half-hardy perennials of slender growth, blooming profusely the whole summer; fine for vases, baskets, etc.
- 6040 **frutescens.** White and blue15
- 6045 **gracilis.** White and purple15
- NIGELLA** (Love-in-a-mist). Interesting and free flowering, half-hardy annuals, with elegant cut foliage and curious flowers, of easy culture. 1½ ft.
- 6050 **Miss Jekyll.** Beautiful long-stemmed variety, bright Cornflower blue.. ¼ oz. 35c .10
- 6052 **Miss Jekyll.** White ¼ oz. 50c .15
- 6055 **Mixed.** Shades of blue and white. Oz. 35c .10
- 6058 **NOLANA atriplicifolia.** 6 in. Lavender-blue rock garden annual, suitable for ground covers and edging.10
- 6060 **NYCTERINIA capensis.** 1 ft. Large heads of sweet-scented, white star-shaped flowers, produced throughout the whole season; hardy annual, ¼ oz. 50c .10
- OENOTHERA** (Evening-primrose). A magnificent class of hardy plants, with large showy blossoms, preferring a light, sandy soil, and warm, sunny situations; July to October, 2 to 3 ft.

- No. Pkt.
- 6065 **fraseri.** Large, deep yellow; fine ¼ oz. \$1.50 \$0.15
- 6068 **fruticosa youngi.** 1½ ft. Large golden yellow, reddish stems.25
- 6070 **lamarkiana.** 3 ft. Enormous yellow flowers from July to October.10
- 6072 **missouriensis.** 10 in. June to August. A low prostrate growing variety with ascending branches. Flowers very large soft yellow.25
- 6073 **odorata.** Yellow, fragrant ¼ oz. 40c .10
- 6075 **speciosa rosea.** Fine rose color ½ oz. 75c .25
- 6090 **OXALIS tropaeloides.** Fast growing, hardy annual, with dark bronze foliage and deep yellow flowers, best suited to edgings, rockwork, vases, etc. 6 in. ¼ oz. 85c .15

PANSY. Too much importance cannot be attached to the culture of these beautiful plants. For early spring blooming the seed should be sown in July or August and the plants protected during winter. Early spring sown seed will give fine blooms during summer and fall. A good, cool, rich soil is essential. Rotted cow manure is the best fertilizer, and one cannot use too much. No fertilizer of a heating nature should be used; give plenty of water through dry weather. You cannot grow good Pansies under trees.

- No. Pkt.
- 6095 **Grey's Prize Exhibition Strain.** This splendid mixture represents the highest perfection of large flowering, new high colored sorts; their brilliancy and richness are most striking. ½ oz. \$2.50, ¼ oz. \$4.00 .50
- 6100 **Grey's Special Mixture.** A grand mixture of the finest varieties, and one of the richest ever sent out; very striking and recommended for market growing ¼ oz. \$2.00, oz. \$7.00 .25

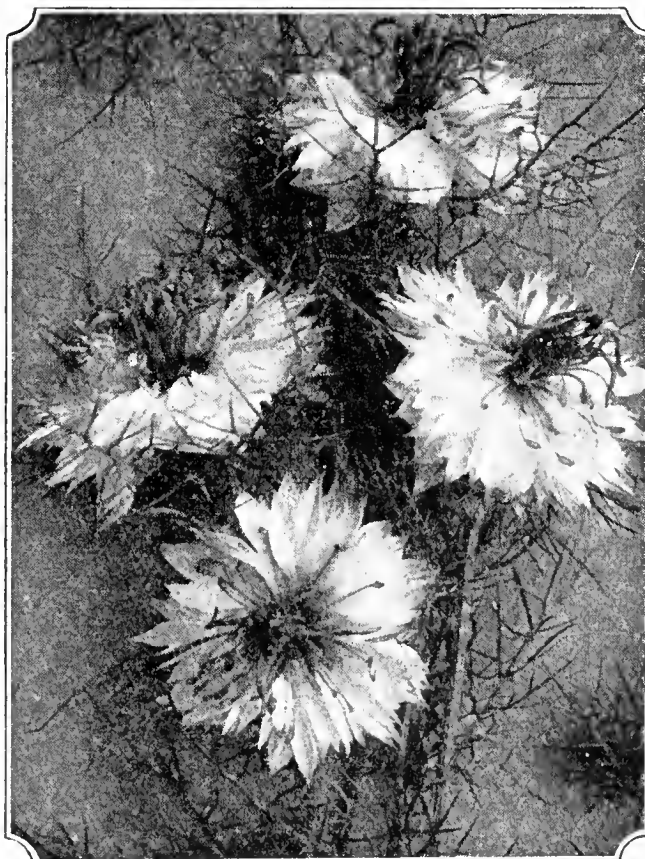

Nigella, Miss Jekyll.



Superb Ruffled Giant Petunias.

PANSY—Continued.

No.		Pkt.
6105	Bugnot's Superb Blotched. Very beautiful class of large flowers with broad blotches. Many of the upper petals are finely lined or veined; great diversity of the handsomest and rarest colors ¼ oz. \$2.00	\$0.25
6110	Cassier's Giant Odier. A strain of great excellence, producing very large, rich and showy flowers ¼ oz. \$2.00	.25
6115	colossea venosa. Giant, round flowers in light veined shades..... ½ oz. \$2.00	.50
6120	English Show. Selected compact strain of the finest large flowering sorts in splendid colors ¼ oz. \$2.50	.25
6125	Giant Trimardeau. Very showy and vigorous size. ¼ oz. \$1.50, oz. \$5.00	.15
6135	Masterpiece. Frilled edge, giant flowers of the richest colors ¼ oz. \$3.00	.25
6140	Matchless. English exhibition strain of immense size and substance in matchless variety of exquisite shades and art colors ½ oz. \$3.00	.50
6147	Swiss Giants, Mixed. Enormous size, very long stems; flowers 3- and 5-blotched. Special greenhouse variety ½ oz. \$2.00	.50

PANSY, Giant, in Separate Colors.

6155	Collection of 6 colors. Our selection....	1.20
6160	Adonis. Light blue; beautiful ¼ oz. \$1.50	.25
6170	Bronze Shades ¼ oz. \$1.50	.25
6175	Cornflower Blue. One of the finest dark blues ¼ oz. \$1.50	.25
6180	Fire King. Crimson, yellow edge ¼ oz. \$1.50	.25
6182	Gold Orange (St. Knud)25	
6185	Golden Queen. Pure yellow .. ¼ oz. \$1.50	.25
6190	Golden Yellow. Dark eye.... ¼ oz. \$1.50	.25

No.		Pkt.
6195	Hortensia Red ¼ oz. \$1.50	\$0.25
6200	King of the Blacks. Velvety ¼ oz. \$1.50	.25
6205	Lord Beaconsfield. Violet, top petals shading off to white .. ¼ oz. \$1.50	.25
6210	Mme. Perret. Mostly rose, ruby and crimson shades on white ground ¼ oz. \$1.50	.25
6215	Peacock. Peacock blue, white edge ¼ oz. \$1.50	.25
6220	Psyche. Velvety violet, bordered with white; waved petals ¼ oz. \$1.50	.25
6225	Ruby King. Extensive range of color from orange scarlet to pink ¼ oz. \$1.50	.25
6230	Silver-edged. Purple, white edge ¼ oz. \$1.50	.25
6235	Snow Queen. Pure white ¼ oz. \$1.50	.25
6245	Violet. Fine violet-blue ¼ oz. \$1.50	.25
6250	Vulcan. Brilliant, dark red, with five large black spots; frilled edges ¼ oz. \$2.50	.25
6255	White. Pure white, violet eye ¼ oz. \$1.50	.25

TUFTED PANSIES. See *Viola cornuta*.

6260	PASSIFLORA caerulea (Passionflower). Fast growing and free flowering, ornamental perennial climbers, with large, showy blue flowers, suitable for conservatory or outside in summer ¼ oz. 85c	.25
------	---	-----

PENTSTEMON. Valuable class of perennials, but are best treated as annuals. Seeds sown in February or March will make a fine display the same season. 2 to 3 ft.

6264	grandiflorum, Excelsior Mixed. Colors range from white to deepest scarlet... .25	
6265	Giant-flowering Hybrids. Superb strain saved from the finest large-flowered sorts; many new and rich colors 1-16 oz. \$1.00	.25
6275	digitalis. Pure white with violet spotted throat ¼ oz. 75c	.10
6280	hartwegi albus. Large, pure white flowers	.25
6285	Southgate Gem. Glowing scarlet.25	
6290	speciosus. Extra deep blue..... ½ oz. 50c	.10
6295	PERILLA atropurpurea laciniata. Dark bronzy purple fringed foliage; very ornamental hardy annual. 2 ft. ¼ oz. 35c	.10

PETUNIA. An exceedingly attractive and favorite hardy annual for both indoor and outdoor cultivation; when not in too rich soil they will flower profusely through the summer. 1 to 1½ ft.

6296	Balcony Blue20	
6297	Balcony Crimson20	
6297A	Balcony Netted Blue Gem. Large steel blue flowers netted with deep violet.... .25	
6298	Balcony Rose20	
6299	Balcony White20	
6300	Balcony Mixed20	
Dwarf Compacta Varieties.		
6302	Fringed Rose25	
6303	Heavenly Blue. 8 in. Light silvery blue. .25	
6308	Striped. 8 in. ¼ oz. \$1.25	.15
6310	Snowball. Pure white ¼ oz. \$1.25	.15
6311	violacea nana compacta ¼ oz. \$1.00	.15
6312	nana compacta Mixed15	
6315	Howard's Star. Rich, dark crimson, with five-pointed white star .. ¼ oz. \$1.00	.15

No.	PETUNIAS—Continued.	Pkt.
6317	Rose of Heaven. A very dwarf, brilliant rose-pink variety 1/8 oz. 75c	\$0.15
6325	Rosy Morn. Lovely, bright pink 1/4 oz. \$1.50	.15
6327	Violet Blue50
6330	White. Pure white, free bloomer. 1/4 oz. 60c	.10
6335	Striped and Blotched. 1/4 oz. 50c, oz. \$1.50	.10
6340	Splendid Mixed. Rich colors, superb strain 1/4 oz. 60c, oz. \$2.00	.10
Grandiflora or Large-flowering Sorts		
6345	Elk's Pride. Large, dark velvety purple, plain edge25
6348	Fimbriata caerulea. Fringed steel blue Petunia, deeper blue throat heavily veined; a very fine light blue sort50
6350	Fringed Perfection. Immense, deeply fringed flowers; exquisite colors25
6352	Fringed Violet Hybrida. Rich velvety violet.35
6355	Superb California Giants. The flowers of this reselected strain are deep throated and very large, of great excellence and variety of colors25
6360	Superb Ruffled Giants. A California strain of extraordinary size and colors with deeply ruffled or fluted edges50
6362	New Dwarf California Giants. A very compact type of the Giant Petunia. Very large, well formed flowers. Specially recommended for pot culture. Throats well marked and veined.75
6364	Theodosia. Fringed, soft rose-pink, large.35
6365	White Beauty. Immense ruffled and fringed snow white flowers25
6367	White Cloud. Compact bushes covered with pure white blooms. 12 in.35
Double Large-flowering Sorts. Seed saved from the most carefully hybridized flowers. The weaker seedlings should be carefully saved, as these invariably produce the finest double flowers.		
6370	Fringed, Grey's Select. One of the finest strains in existence. The double flowers are very large, full and beautifully formed50
6375	grandiflora, Mixed. Choice strain25
6376	Rosy Morn. Double; same color and habit as single Rosy Morn.35
6380	PHACELIA campanularia. Beautiful annual with rich, deep blue, bell-shaped flowers; blooms in about eight weeks from seed. 3/4 ft. 1/8 oz. 35c	.10
PHLOX drummondii. These beautiful, hardy annuals continue in bloom the whole of the summer, and for bedding or massing nothing can surpass them for brilliancy and richness of color or profusion of flowers. 1 to 1 1/2 ft.		
6385	grandiflora collection of 6 colors, separate	.50
6390	Finest Mixed. An improved strain, with very large flowers and trusses; in brilliant colors 1/4 oz. 85c	.10
6395	Brilliant Scarlet 1/4 oz. 85c	.10
6400	Crimson. White star center 1/4 oz. 85c	.10
6410	Rose Pink. Fine shade. 1/4 oz. 85c	.10
6415	Pure White 1/4 oz. 85c	.10
6417	Salmon Pink 1/4 oz. 85c	.10
6418	Violet. White eye 1/4 oz. 85c	.10
6420	Yellow 1/4 oz. 85c	.10
6425	cuspidata, Finest Mixed. Beautiful star-shaped flowers in showy colors 1/4 oz. 75c	.10

No.		Pkt.
6430	Dwarf, Extra Mixed. An excellent, compact strain for pot culture or edgings. blooming early throughout the season. Finest colors. 6 in. 1/8 oz. \$1.00	\$0.25
6433	Apricot 1/8 oz. \$1.25	.25
6435	Bright Scarlet 1/8 oz. \$1.25	.25
6438	coerulea stellata. Mauve, white eye, 1/8 oz. \$1.25	.25
6440	Daybreak Pink 1/8 oz. \$1.25	.25
6445	Pure White 1/8 oz. \$1.25	.25
6446	Yellow 1/8 oz. \$1.25	.25
6450	Collection. 6 dwarf varieties, \$1.25.	
6460	PHORMIUM tenax foliis variegatis (New Zealand Flax). Handsome, decorative plant for greenhouse or garden. The rigid, erect leaves are often 6 ft. in length, narrow dark green, striped with rich yellow and white. The spikes of orange colored flowers are 8 to 12 ft. high25
6465	PHYSALIS francheti (Japanese Winter-cherry). Hardy perennial, treated as an annual, fruiting first season from seed. A Japanese variety of the Ground-cherry, with edible fruit in large brilliant red capsules, which retain their color for months; fine for winter decoration. 2 ft. 1/4 oz. 75c	.15
6470	PHYSOSTEGIA virginica (Texas Heath). Fine hardy perennial, resembling a giant heather with beautiful pink flowers through the summer. Fine for cutting. 2 ft. 1/4 oz. \$1.00	.15
6475	virginica alba. Large white. . . 1/4 oz. \$1.00	.25
PINKS. See Dianthus.		
6480	PLATYCODON grandiflorum. Handsome hardy perennial, with large, deep blue, bell-shaped flowers, from June to Oct; allied to the Campanula. 2 ft. 1/4 oz. \$1.00	.15
6485	grandiflora alba. Large white. 1/4 oz. \$1.00	.15
6490	mariesi. Dwarf, compact sort with rich blue flowers. 1 ft. 1/4 oz. \$1.50	.25



Annual Phlox.

No.		Pkt.
6495	POLEMONIUM caeruleum , blue (Jacobsladder). Fine hardy perennials with large heads of showy flowers, easily grown in any good garden soil. May to August. 2 ft. ¼ oz. \$1.00	\$0.15
	POPPIES, Single Annual Varieties. For hardiness and easy culture these showy plants cannot be surpassed. They are very free flowering and make a gorgeous display.	
6500	Admiral. Large, single, white, with a broad edge of bright scarlet. Oz. \$1.25	.10
6502	American Legion. Brilliant scarlet with white maltese cross. Oz. 75c	.10
6505	Danebrog. Single scarlet, with white blotch on each petal oz. 75c	.10
6510	English Scarlet. The common scarlet field Poppy oz. \$1.25	.15
6515	glaucum (Tulip Poppy). Vivid scarlet, 1 ft. ¼ oz. 25c	.10
6520	Shirley, Extra Selected. A much improved strain, with flowers of large size and from the most distinct and charming colors. The flowers are of a shining silky texture. 2 ft. .. ¼ oz. 25c, oz. 75c	.10
6523	Apricot. A beautiful shade .. ¼ oz. 40c	.15
6524	Blue Shades ½ oz. 35c	.15
6525	Salmon Shades ¼ oz. 60c	.15
6530	The Bride. Large, pure white, 2 ft. Oz. 75c	.10
6535	umbrosium. Rich vermilion, with black spot at base of each petal. 1½ ft. Oz. \$1.00	.10
6540	Collection of 6 Single Varieties50	
	POPPIES, Double Annual Varieties.	
6545	American Flag. Large, snow white, fringed flowers, bordered with scarlet. 2 ft. Oz. \$1.00	.10
6550	Cardinal Hybrids. Semi-dwarf, beautiful class, with large flowers in richest and brightest colors. 1½ ft. ¼ oz. 30c	.10
6555	Carnation-flowered mixed. Large, showy fringed flowers in choice colors. Oz. 75c	.10
6560	Japanese Pompon, Mixed. Beautiful, small double flowers. 1 ft. ¼ oz. 50c	.15
6565	Mikado. Double white fringed petals, tipped with crimson. 2 ft. Oz. 75c	.10

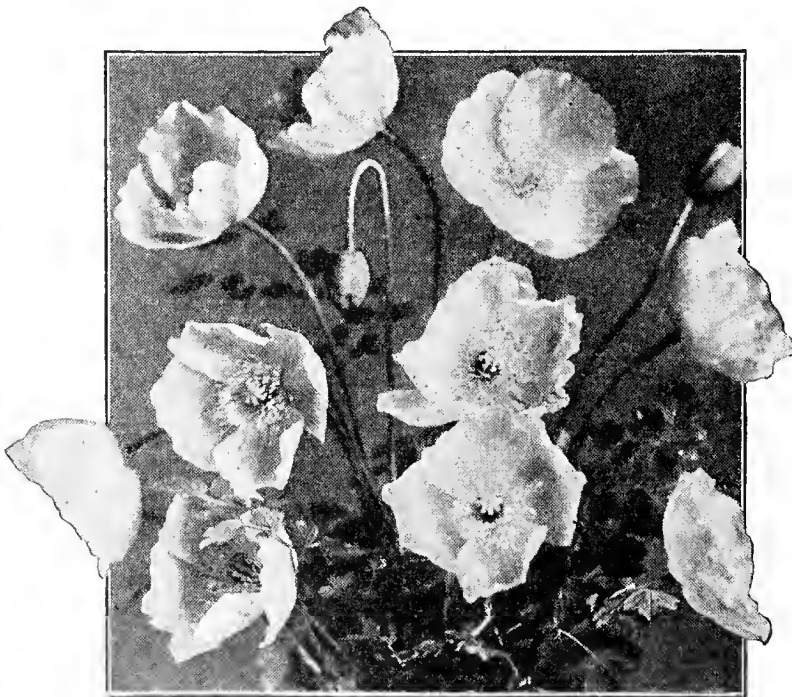

Iceland Poppies.

No.		Pkt.
6570	Peony-flowered Mixed. Immense globular flowers; in choice colors. 2 ft. ... Oz. 75c	\$0.10
6575	Pink. Immense bright pink.... Oz. 85c	.10
6580	Scarlet. Immense flowers..... Oz. 85c	.10
6585	White. Immense, pure white.... Oz. 85c	.10
6590	Yellow. Immense, clear yellow.. Oz. 85c	.10
6592	Cavalcade. New double Begonia-flowered. Orange-scarlet. ¼ oz. 40c	.15
6595	Sweet Briar. New double Begonia-flowered Shirley Poppy. Deep rose-pink15	
6596	salmonium. Double Shirley in all salmon shades15	
6600	White Swan. Dwarf white. 1 ft. ¼ oz. 35c	.10
6605	Collection of 6 Double Varieties50	
	POPPIES, Hardy Perennial Varieties.	
6610	Alpine, Mixed. Pretty dwarf, free flowering sorts, in delicate colors. ½ ft. .25	
6615	Iceland Poppies, nudicaule. Sunbeam Single Mixed. Beautiful border plant with bright, delicate colors, and if sown early will bloom the first year. 1 ft. ¼ oz. \$1.25	.20
6620	Bright Yellow ¼ oz. \$1.25	.25
6622	Iceland, Coonara Pinks. Mixed hybrids in various shades of pink and yellow. Introduced from Australia; will bloom the same season from early spring sown seed. Strong stems and large flowers25	
6624	Iceland, El Monte. Very large, deep tangerine flowers borne on long, wiry stems. Comes true to color. Blooms in six months from seed. Fine as a cut flower.25	
6625	Orange Scarlet ¼ oz. \$1.25	.25
6630	Pure White ¼ oz. \$1.25	.25
6635	Double Mixed. All colors ... ¼ oz. \$1.50	.25
6640	Orientele. Very large, brilliant scarlet with black blotch. 3 ft. .. ¼ oz. 70c	.10
6650	Livermore. Large deep crimson, ½ oz. 75c	.25
6652	Mrs. Perry. Orange-apricot25	
6654	Pink Beauty. Light pink. ... ½ oz. \$1.00	.25
6655	Queen Alexandra. Bright rosy salmon	.15
6660	Royal Scarlet. Immense blooms. ½ oz. 50c	.15
6665	Salmon Queen. Salmon-yellow. ½ oz. 50c	.15
6670	White. New large white25	
6675	Hybrids. Many choice shades. ¼ oz. \$1.00	.15
	PORTULACA. One of our finest hardy annuals, specially adapted to light soils, dry, sunny situations and exposed rockeries. Flowers freely during the hottest weather. 6 in.	
6680	Double-flowered, Mixed. Perfectly double flowers in brilliant and striking colors ¼ oz. \$1.25	.25
6685	Single-flowered, Mixed. Large flowers in most brilliant colors. ¼ oz. 60c, oz. \$2.00	.10
6690	Rose ¼ oz. 60c, oz. 2.00	.10
6695	Scarlet ¼ oz. 60c, oz. \$2.00	.10
6700	White ¼ oz. 60c, oz. \$2.00	.10
6705	Yellow ¼ oz. 60c, oz. \$2.00	.10
6710	Collection of 4 colors, separate35	
	POTENTILLA. A showy class of hardy perennials, producing in great abundance rich colored flowers of velvety texture; July to October. 1½ to 2 ft.	
6715	Double Hybrids, Mixed25	
6720	Single Hybrids, Mixed ¼ oz. 60c	.15

No.		Pkt.
	PRIMULA or PRIMROSE. Hardy and half-hardy sorts. The following Primulas are exceedingly charming and useful plants for growing under glass or in the open air. Most of the hardy sorts require, in our climate, protection during winter.	
6725	auricula. Saved from a large and varied collection of choice colors	\$0.25
6730	Garden Primrose, New Hybrids (Acaulis). An excellent, large flowering strain of bright colors	1/8 oz. \$3.00 .25
6735	Blue. Clear blue color25
6740	Yellow. English Primrose ..	1/8 oz. \$1.50 .25
6745	polyanthus, Giant Mixed. New large flowering strain of the brightest colors25
6750	Finest Fancy Mixed. Extra choice strain15
6755	Gold Laced. Yellow edged sorts15
6759	Large-flowered Bedding Hybrids. Dwarf upright25

	PRIMULA chinensis (Chinese Primrose). All chinensis and stellata Primroses are grown for us by an English specialist who grows nothing but Primulas. For excellence in every point they cannot be equalled.	
6760	Grey's Giant Mixture. A mixture of giant Primroses	1.00
6765	Half packet of Giant Mixture50
6770	Grey's Giant White. The largest and best white ever sent out; flowers of great substance	1.00
6775	Grey's Giant Pink. The finest and largest flesh pink; petals extremely large and of great substance	1.00
6780	Grey's Giant Crimson. Most lovely rich velvety crimson, fine habit, good substance and very free flowering	1.00
6785	Grey's Giant Salmon. A distinct and valuable sort with massive trusses of salmon-pink flowers well above the foliage	1.00
6790	Grey's Giant True Blue. Beautiful fringed blossoms of immense size, fine substance and freely produced; the best blue	1.00
6795	Grey's Orange King. A grand new sort, said to be an entirely new color in Primulas, a beautiful orange color in bud and when open of a terra cotta shade with orange-salmon around the edge; very large and free	1.00

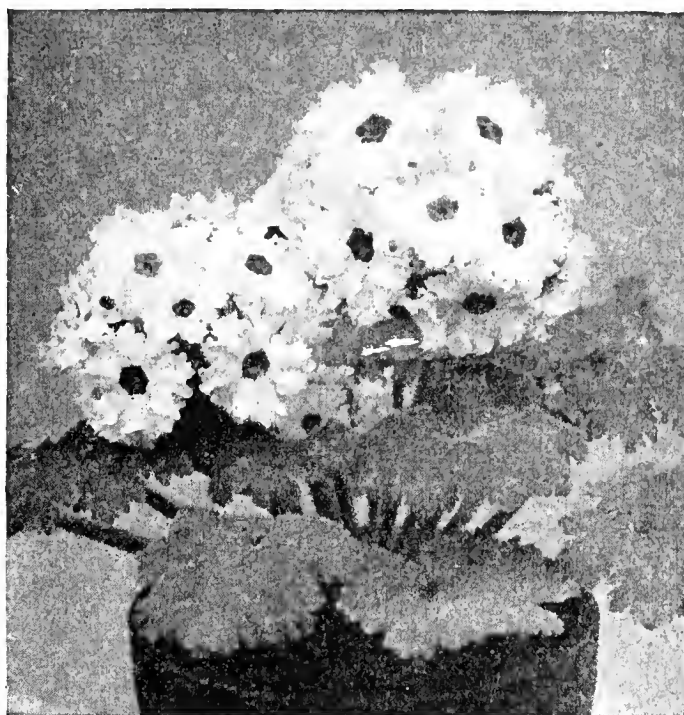

Primula chinensis.

No.		Pkt.
6800	Giant Art Shade. One of the most lovely yet introduced. The immense blooms are fringed and curved; the color is an art shade of an intense fiery glare	\$1.00
6810	Giant Chiswick Red. Improved strain, with large, beautifully fringed crimson-scarlet flowers75
6835	Giant King George V (New). The darkest crimson yet offered, of giant size, beautifully fringed, very free flowering and of massive substance75
6840	Giant Queen Mary (New). One of the finest ever raised, erect, free flowering, of great substance, and of a lovely delicate flesh pink color75
6845	Giant Ruby Queen. One of the finest of all the deep red sorts; the flowers are large, finely fringed, and of an intense rich scarlet with bright yellow eye75
6850	Giant Duchess. Most distinct and beautiful, having large pure white flowers with a zone of carmine-crimson around a clear yellow eye.75

PRIMULA stellata, or Star Primrose. This valuable and very distinct variety should be extensively grown for greenhouse and table decoration. The innumerable star-shaped flowers make an effective contrast to the attractive dark foliage.

6855	Blue Star Improved. A strain of very large dark blue flowers and pale green foliage75
6860	Brilliant Rose Star. Bright rose flowers and graceful, dark green fern leaf foliage, which is red underneath75
6865	Crimson Star. Fine colored sort with large, brilliant, rich crimson flowers75
6870	King of Star. Deep crimson75
6875	Salmon Fink Star. Improved strain75
6880	White Star. Improved large, pure white75
6885	Mixed Star. A special mixture75

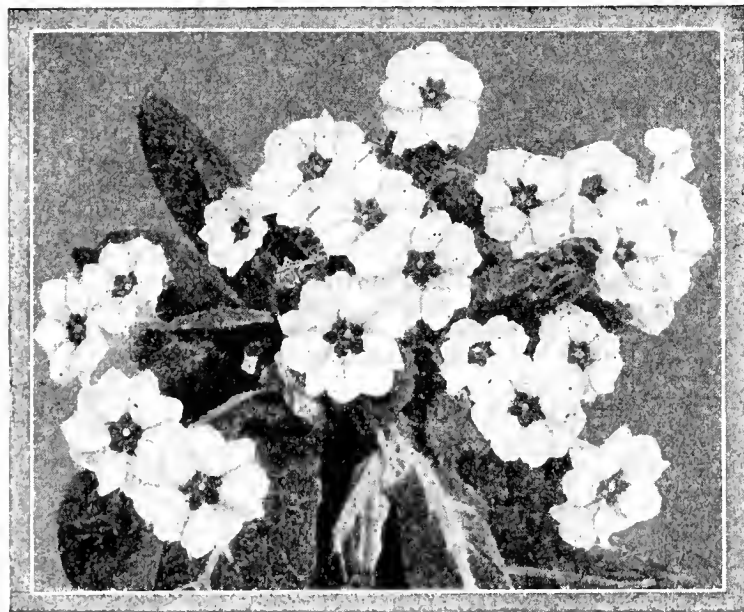

Primula vulgaris, English Primrose.

No.		Pkt.
	PRIMULA obconica. A beautiful and continuous blooming variety with handsome spikes of flowers and pretty foliage. For winter blooming, seed should be sown in April or May in good porous loam. The grandiflora sorts are the freest blooming, but the individual flowers are not as large as the gigantea type.	
6890	grandiflora alba. Large, pure white	\$0.25
6895	carminea. Large, carmine-red25
6900	hybrida. Finest giant flowered sorts, mixed50
6905	Giant fimbriata. Giant fringed sorts50
6910	Apple Blossom. Delicate pink.....	.50
6915	Bright Rose50
6920	lilacina. Dark lilac50
6925	oculata. Dark-eyed varieties50
6935	Rich Crimson50
6937	Salmon. A fine shade50
6940	forbesi (Baby Primrose). Rosy lilac, yellow-eyed flowers. Blooms in three months after sowing25
6945	PRIMULA kewensis. A great acquisition as a winter flowering decorative plant and excellent for cutting. The flowers are bright yellow. Very fragrant, on erect stems 12 to 18 in. long50
6950	PRIMULA Malacoides. Very free flowering species from China and an excellent pot plant for indoor growing; the flowers are ½ to ¾ in. across, of a light lilac color25
6951	Baby Rose Ericksoni. Very deep rose-pink.	1.00
6956	New Baby Ericksoni Lavender-pink	1.00
6962	Pink Beauty. Rose-pink shading mauve.	.30
6963	Salmon Beauty30
6964	Snow Queen. Large pure white35
6965	Superba. Deep pink, fine greenhouse variety.30
6966	Wonder Baby Ericksoni. Beautiful pink..	1.00
	PYRETHRUM. Handsome, hardy perennials, indispensable for herbaceous borders or for cutting. They grow best in cool, moist situations, 2 ft.	
6970	Double Hybrids, Mixed. Saved from a choice strain of double and semi-double flowers, in finest colors ... ¼ oz. \$3.00	.25
6972	Double Hybrids, Kelway's. Saved from their unequalled collection of named sorts50



Pyrethrum, Single and Double.

No.		Pkt.
6975	Single Hybrids, Mixed. Single Daisy-like flowers in rich colors ¼ oz. \$2.00	\$0.20
6976	Single Hybrids, Kelway's. Superb large flowering sorts with immense single flowers of richest colorings. ½ oz. \$1.50	.25
6978	Single Crimson15
6980	Single Rose15
6982	Single White15
6985	PYRETHRUM aureum (Golden Feather). Bright golden foliage used extensively for summer bedding, edgings, and ribbon work. Treated as annuals. ¾ ft. ¼ oz. 50c	.15



Ranunculus, Double French.

6995	RANUNCULUS, Double Mixed French. Beautiful double Buttercup-like flowers in great variety of choice colors; flowering first season from seed; hardy with protection. ¾ ft. ¼ oz. 75c	.15
	RESEDA. See Mignonette.	
7000	RHODANTHE, Mixed. Handsome pink and white, annual everlasting; excellent for bouquets of dried flowers. 1 ft. ¼ oz. 40c	.10
7005	manglesi. Bright pink; beautiful ¼ oz. 60c	.15
	RICINUS (Castor-oil Bean). Large, luxuriant, rapid growing foliage plants, palm-like leaves, brilliant colored fruit. In center of beds or singly on lawns, they produce a fine effect; half hardy annual.	
7010	borboniensis. Large, purplish green leaves, 15 ft.oz. 40c	.10

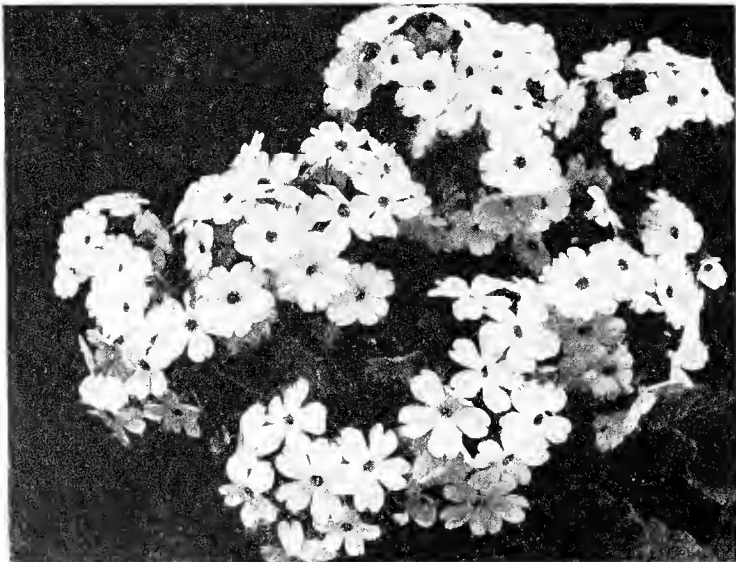

Primula Obconica.



Salvia Splendens.

			Pkt.
7064	SALPIGLOSSIS, Primrose	¼ oz. \$1.00	\$0.15
7065	Purple, Golden Veined	¼ oz. \$1.00	.15
7070	Rose, Golden Veined	¼ oz. \$1.00	.15
7075	Scarlet, Golden Veined	¼ oz. \$1.00	.15
7078	Velvet Violet	¼ oz. \$1.00	.15
7080	Large-Flowering, Mixed	¼ oz. \$1.00	.15
7085	Emperor, Mixed. A robust class, with only one leading stem covered with immense flowers of richest colors	¼ oz. \$1.00	.15
7090	Dwarf, Mixed. New class, 12 to 15 in. high, with larger flowers more freely produced than the tall growing25
7095	Collection of 6 Colors. Separate75
SALVIA. One of our handsomest and most showy summer and autumn flowering plants forming compact bushes, which are literally ablaze with brilliant flowers from July to frost.			
7098	America (Globe of Fire)	½ oz. \$1.25	.25
7100	farinacea. Remarkable for its long flower spikes of lavender-blue. 3 ft.	½ oz. \$1.00	.15
7102	farinacea, Blue Bedder. Compact, deep blue; fine for bedding or borders	½ oz. \$1.50	.25
7103	horminum violacea. Half-hardy annual. 2 ft. Violet-blue..		.15
7105	patens. Rich blue. 2 ft.	½ oz. \$1.75	.25
7110	splendens, Bonfire. Finest compact sort of very even growth, with dense spikes of vivid dark flowers. 2½ ft.	¼ oz. \$1.50	.20
7115	splendens, Fireball. Compact sort, with large, scarlet flower spikes, early and rich flowering. 2 ft. ¼ oz. \$1.75		.20

			Pkt.
7015	RICINUS cambodgensis Best dark-leaved sort. 6 ft.	Oz. 40c	\$0.10
7020	gibsoni. Dark purple stems and foliage. 6 ft. Oz. 35c		.10
7025	gibsoni mirabilis. Dwarf reddish foliage. 4 ft. ...	Oz. 35c	.10
7030	sanguinensis. Red stalks and fruit. 8 ft. .Oz. 30c		.10
7035	zanzibarensis, Mixed. A distinct race with enormous leaves varying in color from pale green to brownish purple	Oz. 25c, ¼ lb. 75c	.10
7045	ROMNEYA coulteri (Giant White California Poppy). A California perennial, with immense, pure white, fragrant flowers, with golden center, blooming continually from June to September; makes a fine pot plant and requires protection in winter. The seed will sometimes remain dormant for months after planting. 3 ft.15
RUDBECKIA (Coneflower). Beautiful border plants lasting a long time in bloom and excellent for summer and autumn display; each bloom is like a miniature sunflower. 2 ft.			
7050	bicolor superba. Orange-yellow with velvety brown center; annual	¼ oz. 50c	.15
7052	Kelvedon Star. Annual. Deep golden yellow with mahogany zone; long-stemmed. Single and semi-double25
7054	My Joy. Bright orange flowers sometimes 5 inches across, with small centers. Excellent for cutting and for borders20
7055	newmanni. Golden yellow with velvety maroon center; hardy perennial15
	purpurea. See Echinacea.		
7060	SAINTPAULIA ionantha grandiflora. Charming greenhouse plant, with beautiful deep blue flowers, 1¼ inches in diameter, resembling the violet.		.25
SALPIGLOSSIS, Improved Large-Flowering. Very beautiful free flowering annuals in great variety of color. The large, richly colored flowers are elegantly veined, and penciled, blooming from July to frost, and are splendid for cutting. 2 ft.			
7062	Crimson	¼ oz. \$1.00	.15
7063	Light Blue and Gold	¼ oz. \$1.00	.15



Salpiglossis.

SALVIA—Continued.

No.		Pkt.
7120	SALVIA splendens grandiflora. Large, brilliant scarlet flower spikes. The most popular sort grown. 3 ft. ... ¼ oz. \$1.00	\$0.10
7122	splendens, Harbinger. Dwarf, compact dazzling scarlet, dark foliage. Seed planted in February will flower in June	.30
7130	splendens, Ostrich Plume. The spikes of flowers are like plumes; of the brightest scarlet, and the bush is well covered; each plume is a bouquet in itself	.25
7135	Zurich. The very earliest flowering variety; it is of a rich scarlet and suitable for pot growing, as it is very dwarf. 1 ft.	.25
7140	SANVITALIA procumbens fl. pl. Pretty free flowering hardy annual, with double flowers of a bright yellow. 9 in. ... ¼ oz. 75c	.15
	SAPONARIA. Compact growing, hardy annuals, with small starry flowers from July to September.	
7145	vaccaria. Beautiful pink feathery flowers. 3 ft. ... ¼ oz. 20c	.10
7150	vaccaria alba. White-flowered; a fine market flower. ... ¼ oz. 20c	.10
	SCABIOSA, Improved Large-Flowering (Mourning Bride). One of our best summer flowering annuals. The rich and beautiful colored flowers are very handsome and excellent for cutting; profuse bloomer. June to Oct. 2½ ft.	
7155	Azure Fairy. Delicate mauve ... ¼ oz. 50c	.10
7156	Blue Cockade. Pure deep azure-blue. 3 ft.25
7158	Cattleya. Rich rosy lilac of the beautiful orchid tone	.25
7160	Cherry Red. Bright color ... ¼ oz. 50c	.10
7165	Fiery Scarlet. Brilliant color ... ¼ oz. 50c	.10
7170	King of Blacks. Black purple ... ¼ oz. 50c	.10
7172	Giant Loveliness. Flowers salmon-rose shades. Fragrant. Strong stems	.25



Schizanthus.

No.		Pkt.
7175	Rose Pink. Beautiful shade ... ¼ oz. 50c	\$0.10
7178	Peach Blossom. Peach-blossom-pink	.20
7180	Purple. Edged white ... ¼ oz. 50c	.10
7182	Shasta. Enormous white Californian variety	.20
7185	White. Large pure white ... ¼ oz. 50c	.10
7186	Yellow. ... ¼ oz. 50c	.10
7190	Mixed. All colors ... ¼ oz. 50c	.10
7195	Collection of 6 colors. Our selection	.50
	SCABIOSA, Hardy Perennial Varieties. Of great value either in the herbaceous border or for cutting, 2 ft.	
7200	caucasica. Beautiful lilac-blue. ¼ oz. \$2.50	.15

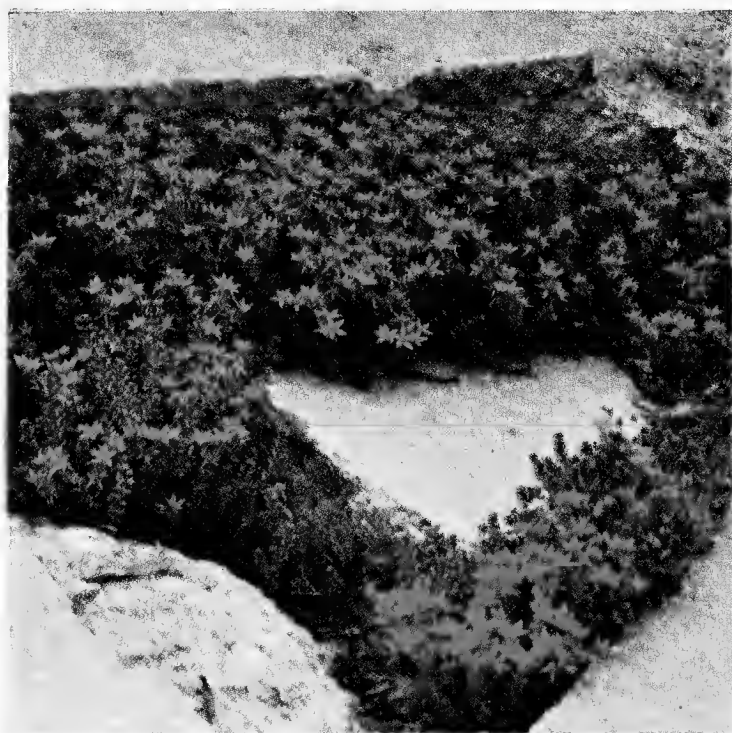

Sedum Acre.

SCABIOSA, Hardy Perennial Varieties.		
7202	Columbaria. A low growing pink Scabiosa, very large flowers	\$0.30
7203	caucasica, Isaac House strain. Giant Hybrids.	.35
7204	caucasica. Pure white.	.25
7205	Large-flowered Hybrids	.25
	SCHIZANTHUS (Butterflyflower). Beautiful annuals for house or garden. 1½ ft.	
7210	hybridus grandiflorus. Very fine new large flowered varieties. ... ¼ oz. 75c	.15
7215	Giant Hybrids (Garaways). A beautiful strain for greenhouses	.50
7220	wisetonensis. Containing the most delicate shades of white, pink, rose and crimson; excellent for pot culture. 1-16 oz. \$2.00	.25
7222	wisetonensis. Rose and amber shades.	.25
7225	Bridal Veil. Glistening snow white; very compact. 16 in.	.25
7226	Snowflake. Compact, pyramidal habit. Pure white frilled edges.	.25
7228	Pink Pearl	.25
7229	roseus compactus. A fine greenhouse variety	.60
7230	SCHIZOPETALON walkeri. Hardy annual, producing quantities of white, almond-scented flowers, which are elegantly fringed at edges. June to October. 1 ft.	.15
7235	SEDUM (Stonecrop). Mixed. Suitable for rock work, edgings and dry situations; their glaucous foliage and bright flowers invariably attract attention; hardy perennial. 4 in. ... ¼ oz. \$1.25	.20
7238	acre. Bright yellow. 3 in., hardy	.25
7240	coeruleum. Blue-flowered annual variety.	.25
7241	spectabile. 1 ft. Perennial. Large lavender-pink flowers.	.25
7245	SHAMROCK. True, small leaved variety; imported seed ... ¼ oz. 50c	.10
7248	SIDALCEA hybrida. Hardy, 2½ to 3 ft. June-July. In many shades of rose, pink, red, salmon, lilac and heliotrope.	.25

No.		Pkt.
	SILENE (Catchfly). Very pretty and profuse blooming plants.	
7250	armeria, Mixed. Free flowering hardy annual, with pink, white and red flowers. 1 ft. ¼ oz. 25c	\$0.10
7255	pendula, Peach Blossom. Beautiful bright pink annual variety for spring bedding, edgings, etc. ¼ oz. 35c	.10
7260	orientalis. Fine hardy perennial with large globular heads of beautiful pink flowers; blooms from June to August and is fine for cutting; flowers first season from seed. 2½ ft. ¼ oz. 50c	.10
7265	SMILAX (Myrsiphyllum asparagoides). A climbing plant unsurpassed for its graceful foliage and orange blossom fragrance of its flowers....¼ oz. 35c	.10
7270	Myrtle-leaved. New and distinct form, more graceful than preceding 100 seeds 75c	.20
	SNAPDRAGON. See <i>Antirrhinum</i> .	
7275	SOLANUM capsicastrum nanum (Jerusalem Cherry). Very ornamental plants for house or greenhouse, being almost completely covered with bright scarlet berries. Early spring sown seed will produce fruiting plants in the autumn. 1 ft. ¼ oz. 50c	.10
7280	Cleveland. Very large, brilliant berries. A fine decorative plant	.15
7282	Blavacek's Masterpiece. Large scarlet.	.15
7284	STATICE (<i>Sea Lavender</i>). Dumosa. Perennial. 2½ ft. Pure silvery grey.	.25
7285	Mixed. Beautiful hardy perennial	.10
7290	latifolia. Deep lavender-blue.. ⅛ oz. 40c	.10
7290A	sinuata, Annual Mixed. ¼ oz. 40c	.15
7291	sinuata, Blue ¼ oz. 40c	.15
7291A	sinuata, Lavender. ¼ oz. 40c	.15
7292	sinuata, Rose ¼ oz. 40c	.15
7293	sinuata, White ¼ oz. 40c	.15
7293A	suworowii (<i>Russian Statice</i>), Annual. Tail-like spikes of pink flowers	.15
7294	bonduelli. Yellow	.15
	STEVIA. Free flowering greenhouse perennials, with sprays of tiny flowers. 2 ft.	
7295	eupatoria. Fine pinkish white. ⅛ oz. 35c	.10
7300	serrata. Pure white, fragrant	.15
	STOCKS (<i>Gilliflower</i>). One of the most highly prized of all our cultivated flowers. The delightful fragrance, free-blooming character and beautiful colors have made them as desirable for winter cultivation in the greenhouse as for the garden in summer.	
7302	Imperial Buttercup. Giant early, deep rich yellow ⅛ oz. \$1.50	.35
7303	Imperial Golden Rose. Giant early rich bright rose, golden sheen center. ⅛ oz. \$1.50	.35
	LARGE-FLOWERED DOUBLE GIANT PERPETUAL PERFECTION (<i>Cut-and-come-again</i>). An excellent variety of fine branching habit, with large double flowers in great abundance from June till frost. 2½ ft.	
7305	Apple Blossom Pink ⅛ oz. \$1.00	.15
7310	Bright Rose ⅛ oz. \$1.00	.15
7315	Canary Yellow ⅛ oz. \$1.00	.15
7320	Dark Blood Red ⅛ oz. \$1.00	.15
7325	Dark Blue ⅛ oz. \$1.00	.15
7330	Light Blue ⅛ oz. \$1.00	.15
7340	Snow White ⅛ oz. \$1.00	.15
7345	Mixed, Extra ⅛ oz. \$1.00	.15
7350	Collection of 6 colors. Our selection	.75

No.		Pkt.
	SPECIAL LARGE-FLOWERING PERFECTION OF NICE, TEN-WEEKS. Splendid strain for garden or greenhouse, of fine branching habit, with very large, double fragrant flowers. An unusually long and free blooming strain. 2 ft.	
7351	Collection of Six Separate Colors \$0.75	
7352	Almond Blossom. Shell-pink. ... ⅛ oz. \$1.00	.15
7353	Apricot Special Forcing. 2½ to 3 ft. Soft apricot, delicately tinged pink, large and fragrant	.35
7354	Belle of Naples. Old rose ⅛ oz. \$1.00	.15
7355	Beauty of Nice. Delicate flesh pink ⅛ oz. \$1.00	.15
7358	Mont Blanc. White ⅛ oz. \$1.00	.15
7362	Cote d'Azur. Light blue ⅛ oz. \$1.00	.15
7365	Crimson King. Rich crimson... ⅛ oz. \$1.00	.15
7370	Monte Carlo. Yellow ⅛ oz. \$1.00	.15
7375	Queen Alexander. Mauve ⅛ oz. \$1.00	.15
7376	Summer Night. Deep blue ⅛ oz. \$1.00	.15
7377	Violet of Nice. Dark violet ⅛ oz. \$1.00	.15
7378	Mixed ⅛ oz. \$1.00	.15
	MAMMOTH COLUMN TEN - WEEKS Splendid variety; earliest flowering of the Ten-Weeks Stocks; produces only one spike of large, double flowers 2½ ft.	
7380	Crimson ⅛ oz. \$2.00	.25
7390	Light Blue ⅛ oz. \$2.00	.25
7395	Rose Pink ⅛ oz. \$2.00	.25
7400	Snow White ⅛ oz. \$2.00	.25
	STOCK BISMARCK IMPROVED OR IMPERIAL. Large branching habit. Early forcing. 2½ ft.	
7401	Apple Blossom. ⅛ oz. \$1.00	.15
7402	Blood Red. ⅛ oz. \$1.00	.15
7403	Bright Rose. ⅛ oz. \$1.00	.15
7404	Dark Blue. ⅛ oz. \$1.00	.15
7406	Light Blue. ⅛ oz. \$1.00	.15
7407	Peach Blossom. ⅛ oz. \$1.00	.15
7409	White. ⅛ oz. \$1.00	.15
7411	Yellow. ⅛ oz. \$1.00	.15
7416	Mixed Colors. ⅛ oz. \$1.00	.15

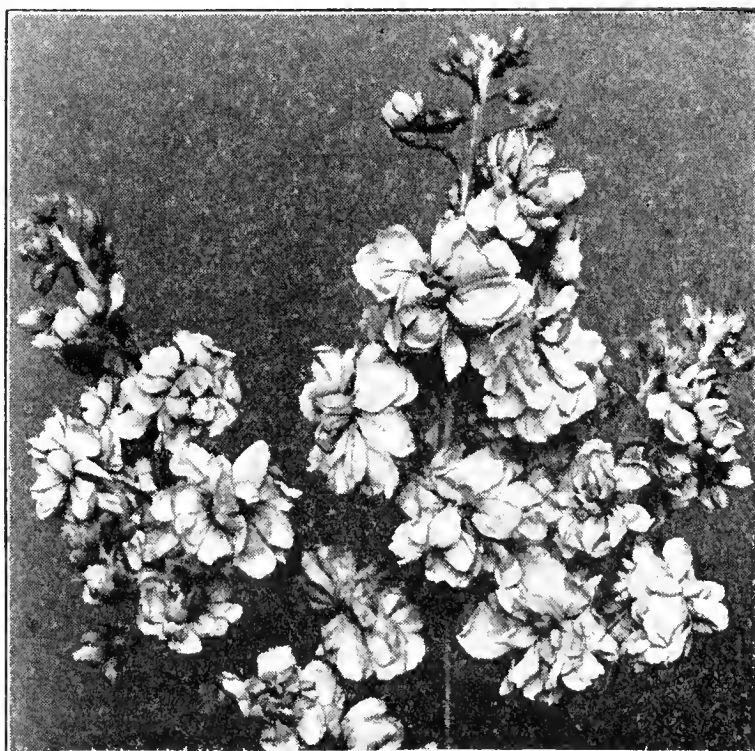

Double Giant Perpetual Perfection Stock.

No.		Pkt.
	DWARF BOUQUET TEN-WEEKS. Dwarf Stock for growing in pots. 8 in.	
7417	Crimson. Fine deep color 1/8 oz. \$1.00	\$0.15
7418	Dark Blue 1/8 oz. \$1.00	.15
7419	Pure White. Excellent 1/8 oz. \$1.00	.15
7420	Light Blue 1/8 oz. \$1.00	.15
7421	Light Rose 1/8 oz. \$1.00	.15
7422	Mixed. All colors 1/8 oz. \$1.00	.15
7423	STOKESIA cyanea (Cornflower Aster). Beautiful hardy perennial with lavender-blue blossoms July to frost. 16 in. 1/4 oz. \$1.50	.25
7424	cyanea. Mixed15
7425	STREPTOCARPUS, Veitch's New Hybrids. Handsome greenhouse perennial, with Achimene-like flowers in clusters on slender stems. Treatment same as for Gloxinia75
	SUNFLOWER. See Helianthus.	
	SWAINSONA. Fragrant, tender perennial for house or conservatory. Graceful foliage and Sweet Pea-like flowers. Grown as a climber or trimmed into bush form. Usually grown in pots.	
7434	Grandiflora. Finest mixed50
	SWEET CLOVER. Grown for the fragrance of their flowers and foliage.	
7440	mellilotus alba. Yellowish white; very fragrant; hardy biennial, 3 ft. oz. 30c	.10
7445	coerulea. Blue flowers; very sweet, hardy annual, 2 ft. oz. 50c	.10

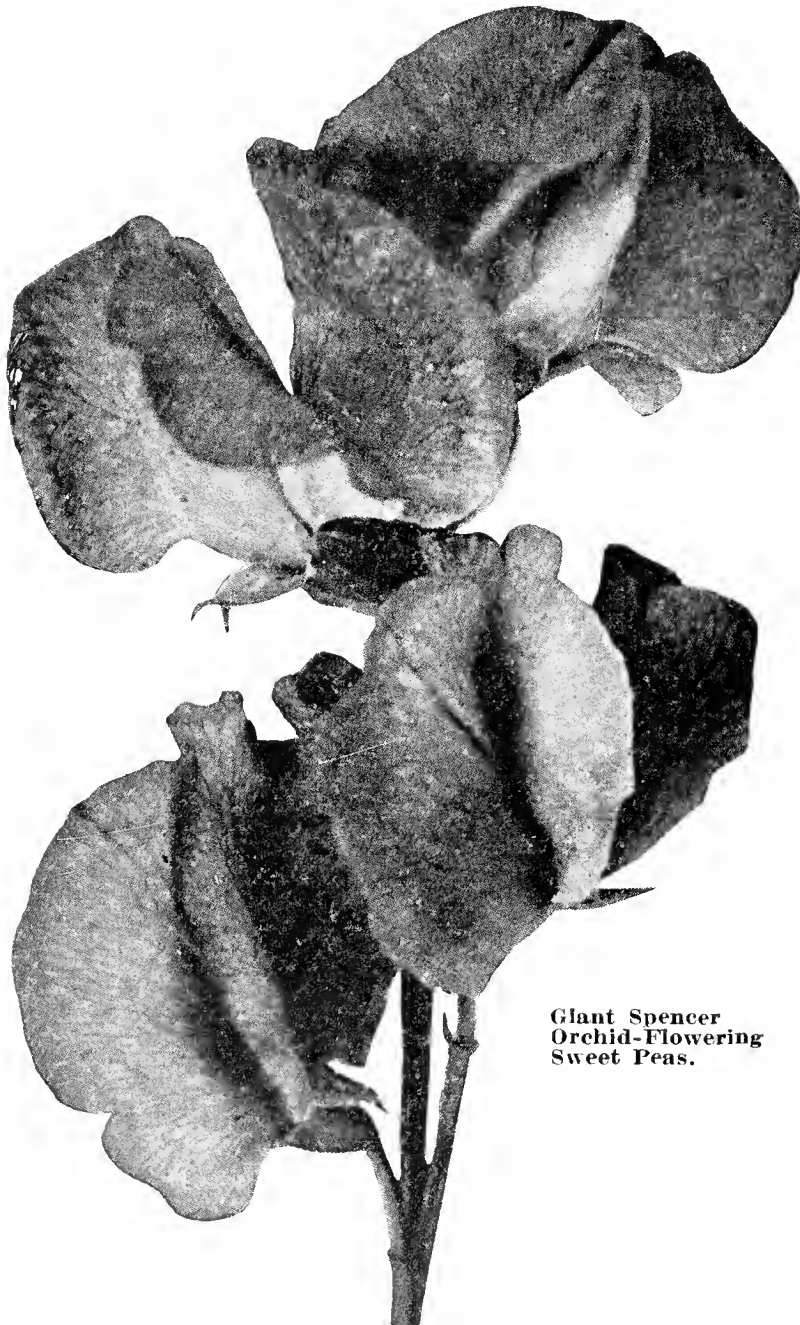

GIANT SPENCER
ORCHID-FLOWERING
SWEET PEAS.

SWEET PEAS

No.		Pkt.
	GIANT SPENCER or ORCHID FLOWERING. Unquestionably the finest type of this most popular flower that has ever been introduced. The waved flowers are of immense size, usually 2 in. or more across and with three to five flowers on a stem. The season of bloom is much longer than the old type. Grow 3 or 4 in. apart in the rows.	
7450	Special Exhibition Mixture. This mixture is made up entirely of the Spencer types and includes the finest sorts and most effective colors; it is without equal and cannot fail to give the greatest satisfaction. Oz. 35c, 1/4 lb. \$1.00, 1 lb. \$3.25 \$0.10	
	Separate Varieties. Oz. 50c, 1/4 lb. \$1.50, unless otherwise priced.	
7460	Angele. Blue-mauve, suffused pink.....	.10
7465	Austin Frederick Improved. Giant true lavender10
7470	Avalanche. Glistening white10
7475	Barbara. Large salmon10
7476	Bon Bon. Rich pink shading amber. Oz. 60c	.15
7480	Bonfire. Bicolor cherry-pink, cream wings10
7485	Campfire. Bright scarlet10
7498	Cattleya Queen. Rose-mauve tinted orchid	Oz. 60c .15
7505	Charming. Deep cerise10
7510	Chieftain. Deep satiny mauve10
7515	Colorado. Bright orange10
7520	Constance Hinton. Mammoth white, black seeded10
7530	Crimson King. Deep crimson10
7535	Defiance. Orange-scarlet10
7550	Doreen. Carmine10
7555	Flamingo. Scarlet-cerise10
7560	Fortune. Dark blue10
7565	Gleneagles. Light blue-lavender10
7570	Glengarry. Deep velvety crimson. Mammoth ruffled and duplexed10
7580	Hawlmart Cerise10
7585	Hawlmart Lavender10
7590	Hawlmart Pink10
7595	Hawlmart Salmon10
7600	Hawlmart Scarlet10
7605	Heavenly Blue. Delphinium blue10
7610	Hebe. Bright pink10
7615	Huntsman. New shade scarlet10
7625	King White. Giant pure white.....	.10
7645	Mary Pickford. Dainty cream-pink suffused salmon10
7650	Matchless. Clear cream10
7655	Mermaid. Blue-lavender10
7660	Model. Large white, black seeded10
7665	Mrs. A. Searles. Pink, merging to red ..	.10
7670	Mrs. Tom Jones. Bright Delphinium blue10
7675	Olympia. Deep purple10
7680	Picture. Rich pink, shaded creamy apricot10
7685	Pinkie. Large rose-pink10
7688	Pirate Gold. Golden orangeOz. 60c	.15
7690	Powerscourt. Lavender10
7698	Rosie. Deep rose-pink10
7700	Reflection. Clear blue10
7702	Ripples. Rose-pink, wavy and semi-duplex10
7710	Royal Purple10
7720	Royal Sovereign. Orange10
7730	Sunkist. Cream picotee rose10
7740	Sybil Henshaw. Deep crimson10
7750	The Sultan. Black-maroon10
7755	Warrior. Giant red-maroon10
7765	What Joy. Primrose yellow10
7770	Winnie Morse. Duplex frilled, cream ground, flushed rose	Oz. 60c .15
7775	Youth. White picotee rose10

No. Pkt.

SPENCER VARIETIES FOR GREENHOUSE

All white seeded varieties will germinate better if sown in small pots of sand, being less liable to decay and can readily be transplanted to permanent place.

¼ oz. 35c, oz. \$1.00 each, unless priced.

7805	Amethyst. Royal purple	\$0.15
7808	Annie Laurie. Rose pink, long stems	
	oz. \$1.50	.20
7810	Aviator. Dazzling crimson-scarlet15
7811	Ball Blue. Clear blue15
7812	Ball Orange. Rich, deep color15
7812A	Ball Rose. Sparkling rose-pink15
7813	Blaze. Glistening fiery orange ..oz. \$1.25	.20
7815	Bluebird. Violet-blue15
7818	Blue Bonnet. Extra large, clear blue ..	.15
7820	Burpee's Orange.15
7830	Edward Zvolanek. Giant lavender15
7832	Eldorado. Rich salmon-orange15
7834	Fragrance. Clear lavender, self color	
	oz. \$1.50	.20
7835	Glitters. Cerise15
7838	Gloria. New sparkling salmon-rose:	
	oz. \$1.50	.20
7840	Grenadier. Dazzling scarlet15
7842	Hope. Mammoth black-seeded white	
	oz. \$1.50	.20
7843	Laddie Rose-pink, white ground15
7845	Lavender Harmony. Clear lavender15
7852	Majestic Rose. Brilliant deep rose.	
	oz. \$1.25	.20
7855	Miss Louise Gude. Brilliant pink15
7860	Mrs. Kerr. Salmon15
7865	New Blue. Deep blue15
7872	Red Cross. Glowing Poppy scarlet15
7875	Snowstorm Improved. Pure white15
7880	Springsong. Salmon-pink15
7892	Valencia. Bright orange, sunproof	
	oz. \$1.25	.20
7895	White Harmony. Black-seeded white15
7905	Zvolanek's Rose15
7910	Mixed, All Varieties .. ¼ lb. \$1.50, oz. 50c	.15

SWEET ROCKET. See *Hesperis*.

SWEET SULTAN. See *Centaurea*.

SWEET WILLIAM. Popular and showy hardy biennial of easiest culture, producing their brilliant colored flowers in great profusion; very desirable for borders and old-fashioned gardens 1½ ft.

8055 **Boston Giant.** An extraordinary strain with flowers as large as a half dol-

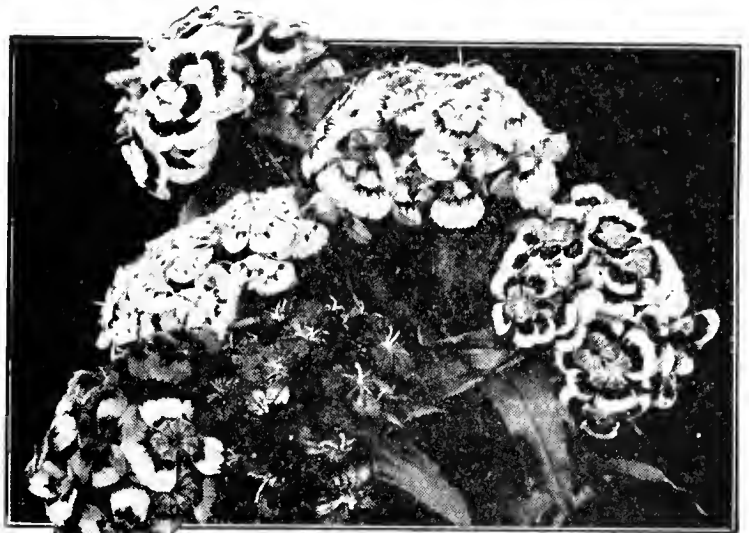

Sweet William, Boston Giant.

No.		Pkt.
	lar and contains colors not in other strains	\$0.25
8060	Double Mixed. Very large flowers in choice colors	¼ oz. 75c .15
8065	Holborn Glory. Extra large flowers, finest colors, with clearly defined eyes	
	¼ oz. 50c	.10
8070	Single Finest Mixed	¼ oz. 50c .10
8075	Dark Crimson	¼ oz. 50c .10
8080	Deep Velvety Maroon	¼ oz. 75c .10
8082	Newport Pink. Beautiful salmon-pink.25
8085	Pure White	¼ oz. 75c .10
8090	Pink Beauty. Soft pink	½ oz. 75c .25
8095	Scarlet Beauty. Vivid	½ oz. 75c .25
8100	Annual Mixed. Flowers of good size and well marked; seed sown in March will bloom the same year. 9 in. ..	¼ oz. 75c .15
8102	THALICTRUM dipteroarpum. 3½ ft. Ornamental foliage and sprays of dainty graceful flowers of violet-mauve with yellow stamens and anthers. Fine for cutting15
	THUNBERGIA (<i>Black-eyed-susan</i>). Beautiful free flowering annual twiners of rapid growth, used extensively in window boxes, vases, etc. 4 ft.	
8105	alata. Yellow, with dark eye....	¼ oz. 65c \$0.10
8110	alba. White, with dark eye....	¼ oz. 65c .10
8115	aurantiaca. Orange, with dark eye	
	¼ oz. 65c	.10
8120	Mixed. All colors	¼ oz. 50c .10
8123	TITHONIA speciosa. Golden flower of the Incas. Annual 6-8 ft. tall, fine for background planting. Flowers single orange-vermilion, similar in growth to a dahlia25
	TORENIA. Beautiful free flowering, tender annuals, suitable for pot culture in house or conservatory. also excellent for the border during the summer, and for baskets and vases are unsurpassed. June to October. 1 ft.	
8125	bailloni. Golden yellow, purple throat..	.25
8130	fournieri grandiflora. Bright blue, with dark blue spots, bright yellow throat..	.25
8135	White Wings. Blush-white, yellow throat.	.25
8140	TRITOMA semperflorens (<i>Flame Flower</i>). Perpetual flowering, showy perennial, with numerous spikes of orange-red flowers from July until frost; excellent for beds or borders. 3 to 4 ft....	.15
8145	hybrida mirabilis. New dwarf annual strain ranging in color from lemon-yellow to deep orange. Sown early and planted out in May, they bloom freely from July until frost. 2 ft.15

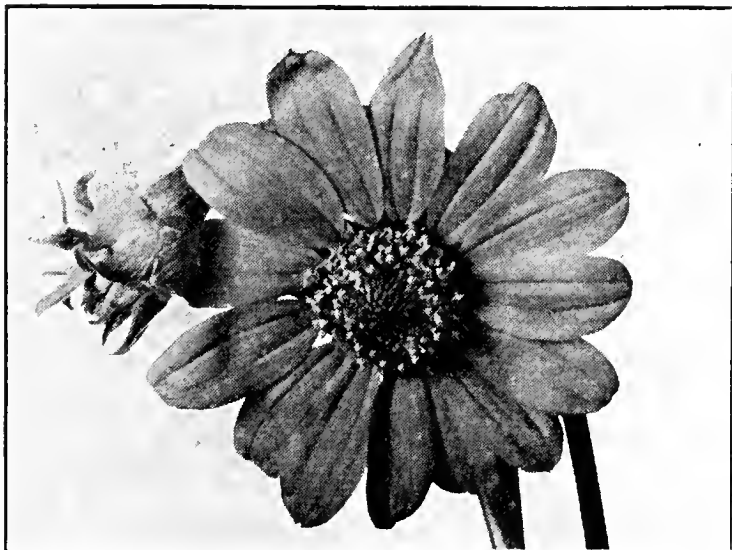

Tithonia speciosa.

No.		Pkt.
	TROLLIUS (Gloflower). Charming spring flowering, hardy perennials, with large globular Buttercup-like flowers.	
8150	Orange Globe. Large, deep orange	\$0.25
8155	Mixed Hybrids. Newest large flowered varieties25
8160	TROPAEOLUM canariense (Canary-creeper). Well-known climbing annual with elegantly fringed, bright yellow flowers. 10 ft.	Oz. 50c .10
8163	URSINIA anethoides. Pretty daisy-like flower from South Africa, color bright orange with a purple zone. Height about 10 inches25
8164	aurora. A dwarf variety with brilliant orange flowers with a broad zone of deep crimson in the center25
8165	VALERIAN, Mixed. Showy, hardy perennial with long spikes of heliotrope-scented flowers. 2 ft.	¼ oz. 35c .10
8170	officinalis (Garden Heliotrope). Large trusses of fragrant pink flowers. 3 ft.25
8173	VENIDIUM fastuosum. Annual. 2-3 feet. Deep orange daisy-like flowers 4-5 inches across with upper row of petal marked with reddish brown zone.25
8174	VERBASCUM phoeniceum Hybrids. A superior strain of these excellent hardy perennials. Plants 3 ft. high with colors ranging from white, pink, rose, purple and bronze to brown	¼ oz. 35c .15
	VERBENA. These are invaluable for summer bedding purposes. Seed sown in March will commence to bloom in June and continue until frost. 1½ ft.	
8175	Grey's Mammoth, Mixed. A grand strain of giant Verbenas, with flowers of exceptional size	¼ oz. 75c, oz. \$2.50 .10
8176	Auricula-flowered Mixed. Large flowers with white eye.	¼ oz. 60c .10
8177	Beauty of Oxford Hybrid. Rose-pink shading to rose-red.	¼ oz. 50c .25
8178	Blue. White eye.	Oz. \$2.50, ¼ oz. 75c .10
8179	Dwarf compacta Mixed.	¼ oz. 50c .20
8182	Etna. Geranium red, yellow eye.	¼ oz. 50c .15
8184	Giant Salmon Pink.	¼ oz. 75c .15
8187	Golden Queen.	¼ oz. 75c .15
8191	Helen Willmott. Salmon-pink, white eye.	¼ oz. 75c .15

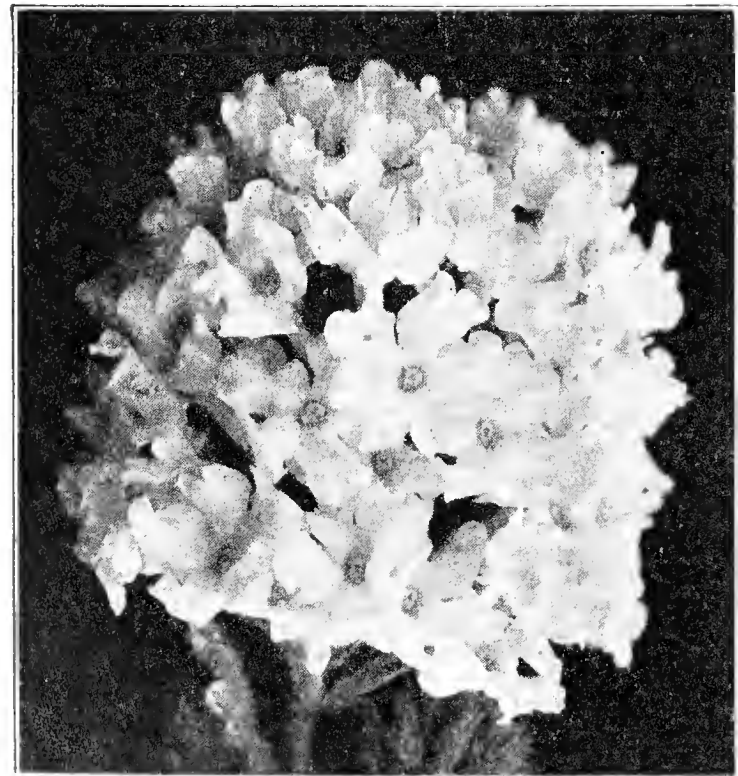

Grey's Mammoth Verbena.

No.	Viola Cornuta.	Pkt.
8193	Lavender Glory. Creamy white eye, fragrant	¼ oz. 50c \$0.25
8194	Rose Queen	¼ oz. 60c .20
8195	rosea stellata. Rose, white eye.	¼ oz. 75c .10
8197	Royale Hybrida. Royal blue, yellow eye.	¼ oz. 60c .20
8200	Scarlet Lucifer	¼ oz. 75c .10
8202	Scarlet Queen. Very large	¼ oz. 60c .20
8203	Snow Queen. Very large	¼ oz. 60c .20
8208	Spectrum Red. Intense bright scarlet, no eye	¼ oz. 75c .25
8210	White hybrida	¼ oz. 75c .10
8212	Erinoides (Moss Verbena). 1 ft. Purple.15
8214	erinoides alba. 1 foot. Moss Verbena. White	¼ oz. 30c .15
8215	Lemon Verbena (Aloysia citriodora). Fragrant foliage for cutting25
8221	venosa lilacina.	¼ oz. 50c .25
8222	venosa. Purple	¼ oz. 50c .15
	VERONICA. Splendid hardy perennials, with showy spikes of bright colored flowers; fine border plant. 1½ to 2 ft.	
8224	longifolia. 2½ ft. Compact clusters of blue flowers15
8225	spicata Blue. Bright blue20
8227	spicata, Mixed20
	VINCA. Handsome, profuse blooming half-hardy perennials, flowering the first season from seed. They have dark green foliage and pretty pink and white flowers; excellent for borders and bedding out. 1 ft.	
8235	Bright Rose	¼ oz. 75c, oz. \$2.50 .15
8240	Pure White	¼ oz. 75c, oz. \$2.50 .15
8245	White, with Rose Eye ¼ oz. 75c, oz. \$2.50 .15	.15
8250	Mixed. All colors	¼ oz. 75c, oz. \$2.50 .15
	VIOLA cornuta (Tufted Pansies). Fine flowering plants, excellent for partially shaded beds or borders, blooming throughout the season; hardier than other Pansies, but with smaller flowers.	
8255	Admiration. Rich, dark blue.	¼ oz. \$1.75 .15
8260	Blue Perfection. Light blue	¼ oz. \$1.75 .15
8265	lutea. Old yellow sort	¼ oz. \$1.50 .15
8266	Papilio Deep Violet15
8270	rosea. Delicate rose	¼ oz. \$1.75 .15
8275	White Perfection. Large white.	¼ oz. \$1.50 .15
8280	Mixed. Finest varieties	¼ oz. \$1.25 .15
8285	Scotch Strains. Choicest and newest bedding hybrids in finest colors.25
8287	Sutton's Bedding Apricot. Rich apricot tinged orange center35
8288	VIOLA, Jersey Gem. A large, compact growing variety, continuous bloomer, deep violet-blue; fine for rockery and border35
	VIOLA odcrata (Sweet scented Violet). A favorite hardy perennial. Easily grown from seed, doing best in a cool, moist situation.	
8295	The Czar. Very large dark blue.	¼ oz. 85c .15
8300	White Czar. Very large white.	¼ oz. 75c .15
8305	Mixed. Blue and white shades.	¼ oz. 50c .10

No.		Pkt.
8310	VIRGINIAN STOCK , Mixed. Early free flowering hardy annual ¼ oz. 75c	\$0.15
8312	Crimson Gem . 8 in. Erect and compact. .15	
8315	VISCARIA , Finest Mixed . Remarkably showy, free flowering hardy annual, for border or masses. The bright flowers are continued through the season. 1 ft. ¼ oz. 25c	.10
	WALLFLOWER . Delicately fragrant half-hardy perennials, with beautiful velvety flowers.	
8320	Double Branching , Mixed. . . ¼ oz. \$1.50	.25
8325	Kewensis . Very fragrant flowers varying from sulphur-yellow to orange and purple-violet ¼ oz. \$1.50	.25
8330	Vulcan . Extra large, velvety crimson-brown flowers ¼ oz. 60c	.15
	WALLFLOWER , Annual . Early flowering single varieties which bloom throughout the summer from spring-sown seed. Excellent for bedding purposes. 2 ft.	
8335	Blood Red ¼ oz. 50c	.25
8340	Earliest Paris . Fine brown. ¼ oz. 50c	.25
8345	Golden Yellow ¼ oz. 50c	.25
8350	Mixed . All colors ¼ oz. 50c	.15
8352	Double Early Wonder Mixed . 2 ft. Blooms within 3 months. ¼ oz. 50c	.15
8365	XERANTHEMUM , Double , Mixed . Showy hardy annual of easy culture, well suited to drying as everlasting. ¼ oz. 60c	.15
8370	YUCCA filamentosa (Adam's Needle). Hardy perennial. The large, white, waxy flowers of drooping habit are borne in huge panicles above the sword-shaped foliage during July and August. 4 ft. ¼ oz. 75c	.15
8374	ZEA japonica Rainbow . Green white, rose and yellow striped foliage. 5 ft. Oz. 25c	.10
	ZINNIA . These attractive and decorative hardy annuals are most desirable for borders or bedding purposes, and are remarkable for the profusion and duration of their flowers, in bloom from June to frost.	
	Giant Dahlia-Flowered.	
	Collection. 12 varieties ¼ oz. Pkt.	\$1.50
8375	Canary Bird . Delicate primrose. 35	.15
8380B	Crimson Monarch 35	.15
8381	Dream . Deep lavender 35	.15
8382	Eldorado . Rose on deep salmon. 35	.15
8382A	Exquisite . Light rose, deep center. 35	.15
8383	Golden Dawn . Beautiful golden yellow 35	.15
8383A	Golden State . Orange-yellow 35	.15
8384	Illumination . Deep rose self color. 35	.15
8384A	Lemon Beauty . Golden yellow or brown; a real pastel shade 35	.15
8384B	Luminosa . Bright deep pink, light suffusion of salmon 35	.15
8384C	Meteor . Glowing deep red 35	.15
8385	Old Rose . A real old rose color 35	.15
8385A	Old Gold . Burnished deep and lighter shades of old gold 35	.15
8385B	Oriole . Orange and gold 35	.15
8386	Polar Bear . Pure white 35	.15
8387	Purple Prince . A deep purple 35	.15
8387A	Scarlet Flame . Bright scarlet 35	.15
8387B	Youth . Light pink 35	.15
8387C	Special Mixture 35	.15
8388	Double Giant Flowering Columbia Strain . Saved from selected prize flowers. 2 ft. ¼ oz. Pkt.	\$0.50
8389	Bright Rose 50	.10
8389A	Burnt Orange 50	.10
8390	Cardinal 50	.10
8395	Crimson 50	.10
8400	Deep Ruby Red 50	.10
8405	Flesh Pink 50	.10
8410	Golden Yellow 50	.10
8415	Light Canary 50	.10
8420	Violet 50	.10

No.		¼ oz.	Pkt.
8425	Scarlet	\$0.50	\$0.10
8430	Salmon Rose50	.10
8435	White50	.10
8440	Columbia Prize Mixture50	.10
8442	Pastel Shades, Mixed50	.10
8445	Collection of 6 Colors . Our selection50
8450	Dwarf Crimson . 1 ft.50	.10
8455	Bright Rose Finkie (New)50	.10
8458	Canary Yellow50	.10
8460	Carmine50	.10
8465	Dazzling Scarlet50	.10
8470	Flesh Pink50	.10
8475	Golden Orange50	.10
8478	Salmon Rose . Good florist's shade50	.10
8480	White50	.10
8485	Mixed . All colors50	.10
8490	Collection of 6 Colors . Our selection50
8502	Gracillima . Dwarf Red Riding50	.10
8505	Lilliput , Mixed . Very small double fine for borders. 1½ ft.50	.15
8508	Canary Yellow50	.15
8510	Crimson Gem . Deep crimson50	.15
8512	Deep Flesh50	.15
8515	Golden Gem . Golden yellow50	.15
8516	Lilac Gem50	.15
8517	Rosebud . Rose-pink.50	.15
8518	Salmon Rose Gem50	.15
8520	Scarlet Gem . Dazzling scarlet50	.15
8522	Valencia . Burnt orange.50	.15
8525	White Gem . Pure white.50	.15
8526	Collection 6 colors75
		¼ oz.	Pkt.
8528	Double Mexican , haageana hybrida Mixed . 1 ft. Small, double blooms of unusual coloring	\$0.50	\$0.15
8529	Single Mexican Hybrids Mixed30	.10
	California Giants . The flowers are very graceful, of large size and flat, with a small, flat center. Height 3 to 4 ft.		
8600	Cerise Queen . Beautiful cerise-rose35	.15
8605	Daffodil . Canary-yellow35	.15
8610	Enchantress . Light rose, deeper rose center35	.15
8615	Golden Queen . Golden lemon35	.15
8620	Grenadier . Bright dark red35	.15
8625	Lavender Gem . Deep lavender35	.15
8630	Miss Willmott . Soft pink35	.15
8635	Orange Queen . Golden orange35	.15
8640	Purity . White35	.15
8645	Salmon Queen . Salmon-rose35	.15
8650	Mixed Colors35	.15
8660	Collection of 10 Separate Varieties		1.25



Double Giant Flowering Zinnias.

Mixed Flower Seeds for Wild Gardens

"Wild Gardens" have proved a marked success, and we are in receipt of the most satisfactory evidence of the estimation in which they are held. Any one who has cultivated flowers knows the constant attention necessary in the care of well laid out beds and borders. To those who cannot give this care, the "Wild Garden" presents a substitute which, for its unusual and varied effects, cheapness, and the small amount of labor necessary for its construction, has no rival. "Wild Garden" seeds are a mixture of over one hundred varieties of flower seeds, and, being mixed together can be offered at a much less price than when sold in separate packets. The different seasons of bloom insure something new almost every day.

8530 **Dwarf Sorts.** ½ oz. pkts., with full directions, each 15c, oz. 25c, 4 ozs. 85c, lb. \$2.50.

8535 **Tall Sorts.** ½ oz. pkts., with full directions, each 15c, oz. 25c, 4 ozs. 85c, lb. \$2.50.

Grey's Collections of Flower Seeds

TEN HARDY ANNUALS, 90c.—1 packet each of the following: Aster American Branching mixed, Balsam Rose-flowered mixed, Calendula Orange King, Centaurea Double Deep Blue, Cosmos Extra Early Mammoth mixed, Delphinium Grey's Imperial mixed, Nasturtium Dwarf Columbia mixed, Petunia Splendid mixed, Scabiosa grandiflora mixed, Zinnia Columbia Prize Mixture.

EIGHT PERENNIALS AND BIENNIALS, 90c.—1 packet each of the following: Canterbury-bells Cup-and-saucer mixed, Coreopsis grandiflora, Delphinium Columbia Hybrids, Digitalis (Foxglove) gloxiniaeflora mixed, Gaillardia grandiflora Hybrids, Hollyhock Double Superb mixed, Lupinus polyphyllus mixed, Sweet William single mixed.

Either Collection 90c



Ornamental Grasses

For borders and ornamental gardening; also, when dried, for winter bouquets and decorations, for which purpose they should be gathered before fully matured.

No.		Pkt.
8540	Finest Mixed. In great variety, for bouquets	\$0.10
8545	Avena sterilis (Animated Oats). Annual. 1½ ft.10
8550	Arundo donax variegata. Variegated foliage; half-hardy perennial. 7 ft.10
8555	Briza maxima (Quaking Grass). Annual. 1 ft.10
8560	Bromus brizaeformis. Drooping; annual. 1½ ft.10
8565	Coix lachryma (Job's Tears). Striped leaves; annual. 2 ft.10
8570	Eulalia japonica zebrina. Beautiful variegated leaves with yellow bars running crosswise; half-hardy perennial. 5 ft.10
8575	Gynerium argenteum (Pampas Grass). Large, silvery plume; half-hardy perennial. 10 ft.10
8580	Hordeum jubatum (Squirrel's Tail). Annual. 2 ft.	Oz. 50c .10
8585	Lagurus ovatus (Hare's Tail). Annual. 1 ft.10
8590	Pennisetum ruppelianum. Beautiful crimson-purple plumes, from spring-sown seed	¼ oz. 60c .15
8595	Stipa pennata (Feather Grass). 2 ft. ¼ oz. \$1.50	.15

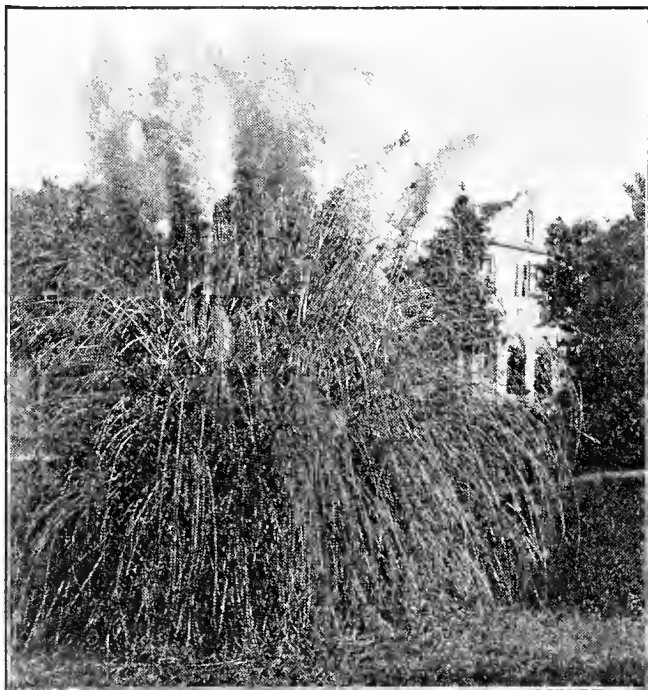

Gynerium argenteum—Pampas Grass.

Specialties in Vegetable Seeds

All prices subject to change without notice.

Pedigreed Asparagus

MARY WASHINGTON. It is earlier, produces more, has larger stalks, possesses highest rust resistance and will net a great deal more money per acre than the Martha Washington. Selected Asparagus roots. \$2.25 per 100, \$20.00 per 1000. Seed, pkt. 10c, oz. 50c, ¼ lb. \$1.50.

Beans

ASGROW VALENTINE. An extremely early entirely stringless Bean. Pods 6½ to 7 in. long and of excellent flavor. Lb. 35c, 2 lbs. 60c.

MASTERPIECE STRINGLESS BUSH. A fine variety for exhibition and for those who demand quality. Lb. 40c, 2 lbs. 75c.

TENDERGREEN. An early, round podded variety, the pods are meaty and of handsome appearance, absolutely stringless and of excellent flavor. Lb. 40c, 2 lbs. 75c.

THE PRINCE (Sutton's). A first early variety producing a heavy crop of long, meaty pods, often measuring from 11 to 12 in. in length. Absolutely stringless and of excellent flavor. Lb. \$1.25, 2 lbs. \$2.00.

Beet

EARLY WONDER. It is an ideal all-season Beet, for while it grows a nice size it retains its tender quality throughout the season. Pkt. 10c, oz. 25c; ¼ lb. 75c.

CROSBY'S EGYPTIAN SELECTED (Arlington Strain). One of the earliest dark leaved varieties; fine quality. Pkt. 15c, oz. 50c, ¼ lb. \$1.50, lb. \$4.00.

Cabbage

CHINESE CABBAGE, CHIHLL. For fine quality, earliness and sure heading, this variety is unsurpassed. Heads grow 18 to 20 inches tall, 3½ to 4 inches thick, tapered near tip. Very firm, well blanched, crisp, tender and sweet. Pkt. 10c, oz. 35c, ¼ lb. \$1.25.

DANISH BALLHEAD. A Winter Cabbage. Extra hard-headed of fine quality. Pkt. 10c, oz. 35c, ¼ lb. \$1.25.

THE GOLDEN ACRE. A new Cabbage, head measuring 9 in. in diameter; 10 days earlier than Copenhagen Market and more compact. Pkt. 10c, oz. 35c.

Carrot

AMSTERDAM FORCING (Coreless). The roots are a bright salmon-red color, blunt ended and small tap-root, the flesh is crisp, sweet, and extremely fine grained. Pkt. 10c, oz. 25c, ¼ lb. 75c.

DANVERS HALF-LONG IMPROVED. Special strain. Grown for us by a leading Carrot specialist. Pkt. 15c, oz. 50c, ¼ lb. \$1.50.

IMPERATOR. An outstanding variety, the roots average about 8 inches long, the flesh is of a rich orange color, fine grained, tender, and of fine quality. Pkt. 10c, oz. 25c, ¼ lb. 75c, lb. \$2.25.

PRIDE OF DENMARK. A wonderfully fine Carrot, 8 to 9 inches long and 2 to 3 inches in diameter, being practically the same size the whole length. It closely resembles the Hutchinson, but has less core and deeper color. Pkt. 15c, oz. 50c, ¼ lb. \$1.50.

Cauliflower

EARLY SIX WEEKS. A very early variety; the heads are pure white, very firm, solid, and of the finest quality. Excellent for forcing. Pkt. 25c, oz. \$5.00, ¼ lb. \$14.00.

Celery

GIANT PASCAL (Arlington Strain). This is the most profitable Celery for fall or winter use, thick, solid, crisp and of rich, nutty flavor. Pkt. 10c, oz. 50c, ¼ lb. \$1.75.

GOLDEN PLUME. It is considered by many gardeners the best of all early varieties. Pkt. 10c, oz. \$1.00, ¼ lb. \$3.50.

EASY BLANCHING. The plants make a rapid and vigorous growth, producing rather thick, solid stalks of excellent quality and rich, nutty flavor. Pkt. 15c, oz. \$1.50.

Sweet Corn

ASGROW GOLDEN COLONEL. A golden yellow late variety Sweet Corn of zig-zag kernel pattern. Grows 7 to 8 feet tall; the ears are large; deep kernels of fine quality and very sweet. Pkt. 25c, lb. 70c, 2 lbs. \$1.25.

GOLDEN CROSS BANTAM. Ears 7 to 8 inches long, 10 to 14-rowed. Slightly lighter yellow than Golden Bantam. Sweet and of fine flavor. Lb. 60c, 2 lbs. \$1.00.

GREY'S MINIATURE WHITE CORN. This extra early variety requires very little garden space, and may be grown successfully in the greenhouse. Grows about 30 inches high; ears 3 to 4 inches long, of fine quality and very sweet. Supply limited. Pkt. 35c, ¼ lb. 60c, lb. \$2.00.

Lettuce

MAY KING (Selected Strain). As a Lettuce for greenhouse forcing, this is the best; the heads form very quickly and are firm and of fine quality. Pkt. 15c, oz. 75c, ¼ lb. \$2.00.

SUTTON'S SUPREME. A fine Lettuce of the Drumhead type, which remains good for a long time before starting seed stems. Leaves prettily edged with red. Pkt. 25c.

WHITE BOSTON. A sure, hard heading variety, the heart and inner leaves are a rich yellow. It is deliciously flavored, very tender, of splendid quality. Pkt. 10c, oz. 50c, ¼ lb. \$1.50.

Melons

GREY'S SELECTED A-1. Flesh deep orange color, very thick and sweet with a delicious flavor, large size and very productive. Pkt. 25c, oz. \$1.00, ¼ lb. \$3.00.

HEARTS OF GOLD. A splendid small, midseason variety. Flesh very thick, deep salmon color, and of high quality; a good shipping Melon. Pkt. 10c, oz. 25c, ¼ lb. 75c.

LAKE CHAMPLAIN (Golden Champlain). An exceedingly early salmon-fleshed Melon of medium size and fine quality. Pkt. 10c, oz. 25c, ¼ lb. 75c.

SUTTON'S A-1. Rich scarlet flesh, large globular fruits; fine flavor. Pkt. 50c.

SUTTON'S UNIVERSAL. Fruits large, flesh is white and very thick, flavor exceptionally fine. Pkt. 50c.



The Golden Acre Cabbage.

Specialties in Vegetable Seeds

Onions

AILSA CRAIG. A handsome variety. Globe-shaped, flesh white, with pale yellow skin. A favorite for exhibition. Pkt. 25c, oz. \$1.00.

CRANSTON'S EXCELSIOR. Handsome, globe-shaped variety, large, solid with small neck, straw color; an exhibition variety. Pkt. 25c, oz. \$1.00.

DANVERS YELLOW GLOBE (Selected Strain). The finest type of this popular variety in the market. Grown for us by an Onion specialist. Pkt. 25c, oz. \$1.00, ¼ lb. \$3.00.

GIGANTIC GIBRALTAR. A handsome straw colored Onion of enormous size, possessed of many sterling qualities. Grand for exhibition. Pkt. 25c, oz. \$1.00.

Peas

ONWARD. Decidedly the best Pea of recent introduction; pods are 4 in. long with 6 to 8 deep green peas of the finest flavor. Lb. 40c, 2 lbs. 75c.

LAXTON'S PROGRESS. This is the finest new early dwarf Pea Laxton has ever yet raised; wrinkled, averaging 9 to 10 peas in a pod. Pods dark green, height 18 to 24 in. Lb. 30c, 2 lbs. 55c.

SUTTON'S SUPER V. C. The largest podded Pea in existence; height from 5 to 6 ft., large pods of fine flavor; an exhibition variety. Lb. 75c, 2 lbs. \$1.40.



THE BRITISHER PEA. A prolific, strong growing variety with medium green foliage. Pods are perfectly straight, pointed at the ends, and of a medium green color, containing nine large, nicely flavored Peas. 4 ft. Main crop; wrinkled. Lb. \$1.00, 2 lbs. \$1.75.

Parsley

DOBBIE'S EXHIBITION. This Parsley has long been recognized as a standard exhibition sort. It is remarkable for its large, fine leaves and close habits. The seed offered has been saved from selected plants only, every one of which was a perfect specimen. Pkt. 25c, oz. 75c.

Squash

DELICIOUS. One of the best varieties for table use. It is a fall and winter Squash, excellent at all seasons. Pkt. 10c, oz. 25c, ¼ lb. 75c.

GIANT STRAIGHTNECK SUMMER. A type nearly double the size of any other summer Squash. Despite its large size the flesh is rich and fine flavored. Pkt. 10c, oz. 25c, ¼ lb. 75c, lb. \$2.50.

HUBBARD, SYMMES BLUE. A superior strain, thick meated, fine grained, dry and very sweet. A heavy cropper and good keeper. Pkt. 10c, oz. 35c, ¼ lb. \$1.00.

THE WARREN. Resembles the Essex Hybrid, but has a shell generally harder and thicker. The color is of a richer and deeper orange. The flesh is of excellent quality. Pkt. 10c, oz. 35c, ¼ lb. \$1.00.

Spinach

NOBEL, GIANT-LEAVED. By far the best of the so-called smooth-leaved varieties. It grows rapidly and remains a long time in marketable condition. Oz. 15c, ¼ lb. 35c, lb. \$1.00.

SAVOY BLIGHT-RESISTING. On account of its resistance to blight, the yield is often very large. A valuable variety to use for fall sowing. Oz. 15c, ¼ lb. 35c.

SAVOY-LEAVED, LONG-STANDING. Darker green and more heavily crumpled than Bloomsdale; will stand 10 days longer before bolting to seed. Oz. 15c, ¼ lb. 35c.

Tomato

BREAK O' DAY. An early Tomato of the Marglobe type; fruit of good size, color scarlet, smooth and of good quality. Pkt. 10c, oz. 50c, ¼ lb. \$1.75.

COMET. One of the best for forcing; brilliant scarlet color; medium size, smooth and solid. Pkt. 10c, oz. 75c, ¼ lb. \$2.25.

LISTER'S EXCELSIOR. This variety is the result of a cross between Ailsa Craig and Lister's Prolific, one of the best for forcing or outdoor culture; a heavy cropper of good flavor and color. Original pkts. 50c.

LISTER'S PROLIFIC. Clusters of fruit are borne in great profusion and are remarkable for the number they carry; smooth and of a rich scarlet color. Original pkts. 50c.

LISTER'S PROTECTION. The best of Lister's productions. Color dark crimson, a heavy cropper; perfect in shape and size. Pkt. 75c.

MARGLOBE. A midseason variety entirely immune from rust, pure scarlet, globe-shaped. Good size, heavy cropper and fine quality. Pkt. 10c, oz. 40c.

SCOTT'S ELLENBANK. A very large cropper, carrying trusses from 3 to 4 lbs. One of the best Tomatoes for indoor or outdoor cultivation. Original pkts. 75c.

Important Free Delivery Notice

Free Delivery. When cash accompanies the order, we will send by Parcel Post to any part of the United States, east of the Mississippi River, all vegetable and flower seeds at quoted catalogue prices, on packages, ounces, quarter-pound, half-pound, pound and two pounds. For larger quantities, the purchaser pays transportation on bulk seeds, Bulbs, Field Seeds, Fertilizers, Grass Seeds, Onion Sets, Plants, Roots, Potatoes, Shrubs, Trees, Insecticides, Tools, and all Garden Requisites, except where free delivery is specified.

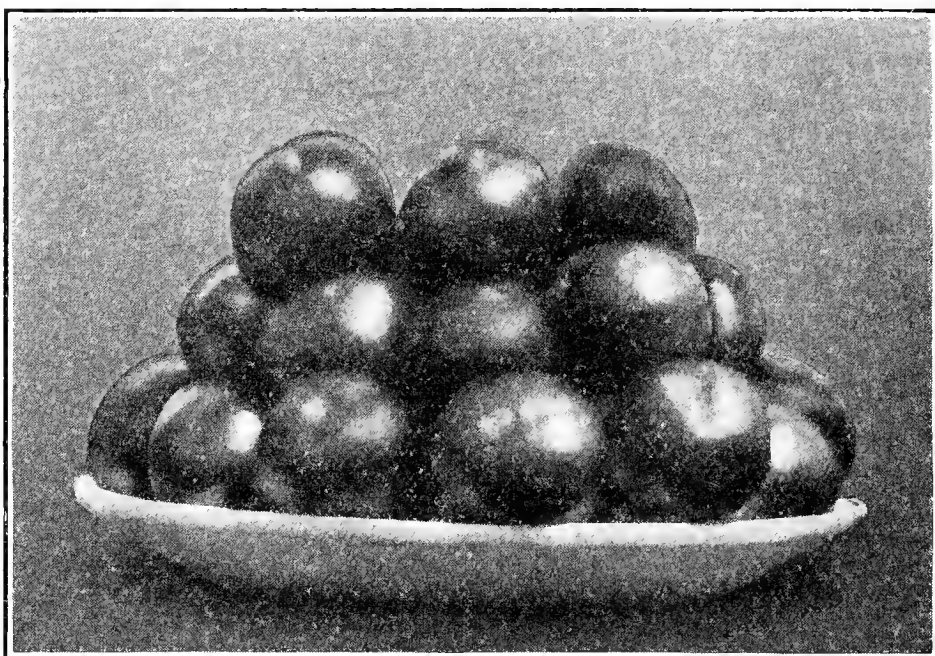

Bonny Best Tomato. (See page 60).

General List of VEGETABLE SEEDS

Our vegetable seeds are of the highest standard, grown for us by specialists. Our aim is purity, quality and service. Free Delivery. We will prepay Parcel Post charges on cash orders at quoted catalogue prices on Seeds, up to two pounds, anywhere in the United States, east of the Mississippi River; for larger quantities, the purchaser pays transportation charges.

Artichoke

Large Green Globe. The best variety; heads large and scales tender and excellent. Pkt. 25c, oz. \$1.00.

Jerusalem (*Helianthus tuberosus*). Cultivated for its edible tubers. April delivery only. Tubers, qt. 40c, pk. \$2.50.

Asparagus

One ounce will produce 200 plants.

A deep, rich, mellow soil is best adapted to the growth of Asparagus. The bed should be made rich by applying a heavy dressing of manure which should be plowed or spaded in; the roots should be set in rows 3 to 4 feet apart and 18 to 24 inches apart in the rows; the crown of the root should be 4 to 6 inches below the surface of the ground. Keep the plants free from weeds during the summer, and protect slightly during the winter. We recommend one-year-old Asparagus roots, as they are usually vigorous, healthy, and will make a better Asparagus bed.

Mary Washington. The latest improved variety. Very large shoots, early, vigorous and quite rust-resistant. Pkt. 10c, oz. 50c, ¼ lb. \$1.50.

Martha Washington. Pkt. 10c, oz. 25c, ¼ lb. 75c.

ASPARAGUS ROOTS

Mary Washington. Select roots. \$2.25 per 100, \$20.00 per 1000.

Martha Washington. \$2.00 per 100, \$18.00 per 1000.

BEANS Dwarf or Bush

2 lbs. of Beans will sow 100 ft. drill, 75 lbs. to an acre.

A warm, light soil is best adapted to the growth of Bush Beans. Plant in rows 2 to 3 feet apart, dropping the beans 3 inches apart and covering 2 inches. Keep the ground free from weeds and cultivate often. All the varieties are tender and must not be planted until the soil is dry and warm.

Before planting Beans, inoculate seed with



Free Delivery. We will prepay Parcel Post charges on cash orders at quoted catalogue prices on Beans, up to two pounds, anywhere in the United States, east of the Mississippi River; for larger quantities, the purchaser pays transportation charges.

We furnish 20c packets of all beans except where noted.

Wax-Podded Varieties

Black Wax, Improved Prolific. Early, very tender and of good quality. Lb. 35c, 2 lbs. 60c.

Black Wax Pencil. Pods are long, pencil-like, very tender and brittle. Lb. 35c, 2 lbs. 60c.

Brittle Wax. The best of the round podded sorts, maturing early, prolific, and bearing long, stringless pods of excellent quality. Lb. 35c, 2 lbs. 60c.

Davis' Kidney Wax. Plant vigorous and of compact, upright growth, with pods extra long, straight, oval. Lb. 35c, 2 lbs. 60c.

Golden Wax. The standard variety for general use; pods long, broad and flat, very fleshy and of fine quality. Vines erect, hardy and productive. Lb. 35c, 2 lbs. 60c.

Round Pod Kidney Wax. The pods are long, straight and extremely handsome. It is an exceedingly heavy bearer. Lb. 35c, 2 lbs. 60c.

Sure Crop Stringless Wax. A valuable new variety of dwarf wax Beans, very productive, rustproof, and will stand a longer season of damp, wet weather than any other wax Bean. Lb. 35c, 2 lbs. 60c.

Wardwell's Kidney Wax. Very long, straight, tender pods. Vines large, vigorous and productive. Lb. 35c, 2 lbs. 60c.

Webber Wax or "Cracker Jack." A high quality, flat-podded, stringless variety. Pods 6 to 6½ in. long, quite broad and uniformly curved, fleshy, stringless and brittle, with little fibre. Lb. 40c, 2 lbs. 75c.

Green-Podded Varieties

Abundance. An extra early variety, producing a heavy crop of long, stringless pods; excellent flavor. Lb. 40c, 2 lbs. 75c.

Asgrow Valentine. An extremely early entirely stringless Bean. Pods 6½ to 7 in. long and of excellent flavor. A fine variety for the private estate and commercial grower. Lb. 35c, 2 lbs. 60c.

Bountiful. Extra early, very prolific and long bearing, flat green pods, tender and stringless. Lb. 35c, 2 lbs. 60c.

Broad Windsor (Sutton's White). English variety, very hardy. Lb. 50c, 2 lbs. 90c.

Emperor of Russia. Extremely prolific and highly esteemed where known. Pods long, slender and meaty. Medium early. French grown. Lb. 50c, 2 lbs. 90c.

Giant Stringless Green Pod. Color deep green, very long, round, fleshy pods; very prolific and entirely stringless. Lb. 35c, 2 lbs. 60c.

Horticultural Dwarf. A shell bean of fine quality, early and productive. Lb. 35c, 2 lbs. 60c.

Horticultural French Dwarf. An improved form of Dwarf Horticultural, producing long pods, beautifully splashed with bright crimson, heavy cropper. Lb. 40c, 2 lbs. 75c.



Webber Wax Beans.

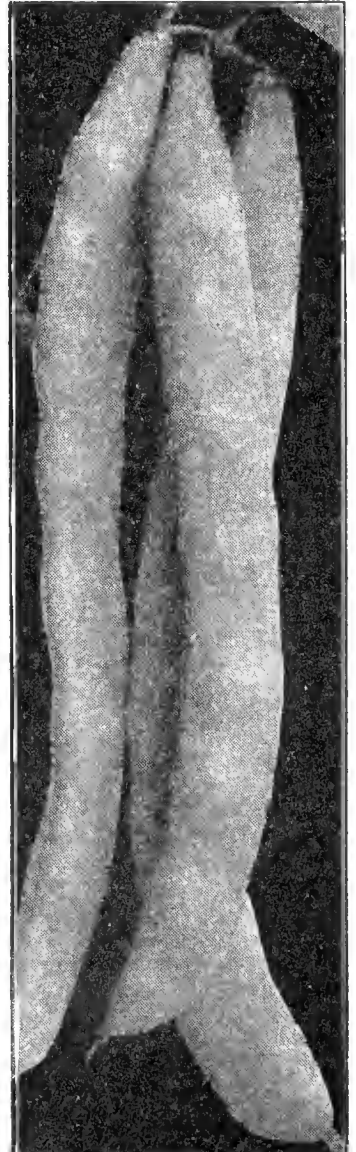

Bountiful Beans.

BEANS, Green-podded Varieties—Continued

- Low's Champion.** One of the best for snap or shell, with stringless, large, green, flat pods. Lb. 30c, 2 lbs. 50c.
- Masterpiece Stringless Bush.** A fine variety for exhibition and for those who demand quality. Lb. 40c, 2 lbs. 75c.
- Plentiful, Sutton's.** One of the earliest varieties and one which we can confidently recommend for all gardens, and especially where forcing is practiced. Lb. 40c, 2 lbs. 75c.
- Refugee, Late or 1000 to 1.** Very tender and productive; the best variety for pickling. Lb. 35c, 2 lbs. 60c.
- Stringless Green Pod, Burpee's.** Extra early, prolific, round pod and stringless. Lb. 30c, 2 lbs. 50c.
- Tendergreen.** An early, round podded variety, the pods are meaty, absolutely stringless, and of excellent flavor. Lb. 40c, 2 lbs. 75c.
- The Prince (Sutton's).** A first early variety producing a heavy crop of long, meaty pods, often measuring from 11 to 12 in. in length. Absolutely stringless and of excellent flavor. Lb. \$1.25, 2 lbs. \$2.00.
- Triumph of the Frames.** The earliest French forcing variety. Lb. 50c, 2 lbs. 90c.
- Valentine Improved.** One of the earliest, pods round, thick and fleshy, of finest quality; leading market variety. Lb. 25c, 2 lbs. 45c.
- Wonder of France.** A valuable French variety for forcing. Lb. 50c, 2 lbs. 90c.

Dwarf or Bush Lima

Lima Beans are very susceptible to cold and wet, and apt to rot in the ground, and should not be planted until all danger from frost is over and the soil is dry and warm.

- Lima, Burpee's Improved Bush.** Best dwarf Lima Beans, large and delicious. Lb. 40c, 2 lbs. 75c.
- Lima, Dreer's Bush.** Possesses all the good qualities of the Dreer's Pole Lima. Lb. 40c, 2 lbs. 75c.
- Lima, Fordhook Bush.** Pods and beans twice the size of Dreer's Lima, and earlier. Lb. 40c, 2 lbs. 75c.
- Lima, Henderson's Bush.** Pods and beans small; of excellent quality as a shell Bean. Lb. 35c, 2 lbs. 60c.

Dwarf Shell Beans

- Improved Yellow Eye.** One of the best sorts for baking, extremely productive and of superior quality. Lb. 20c, 2 lbs. 35c, 8 lbs. \$1.25.
- Vermont Pea Bean.** A most productive small white baking variety, of superior quality. Lb. 20c; 2 lbs. 35c, 8 lbs. \$1.25.
- Red Kidney.** Popular baking Bean. Lb. 20c, 2 lbs. 35c, 8 lbs. \$1.25.

BEANS, Pole or Running

2 lbs. will plant 100 hills, 30 lbs. to the acre.

All under this head require poles 6 to 8 feet long and should not be planted until the ground is warm, as they are more tender than the dwarf varieties. Plant about the middle of May if the season is suitable.

- Burger's Stringless Green-Pod.** The pods, borne in clusters, average 6 to 8 inches in length. Lb. 35c, 2 lbs. 60c.
- Dutch Case-Knife.** Very early and prolific; fine shelled, green or dry. Lb. 35c, 2 lbs. 60c.
- Golden Cluster.** The earliest of the pole wax Beans and very productive. Quality excellent. Lb. 35c, 2 lbs. 60c.
- Improved Kentucky Wonder.** Excellent, very productive. Pods a silvery-green color of large size and entirely stringless. Lb. 30c, 2 lbs. 50c.
- Italian Pole.** A green-podded pole string Bean, absolutely stringless, unsurpassed for a string or shelled Bean. Lb. 75c, 2 lbs. \$1.35.
- Kentucky Wonder Wax.** A Wax Pole Bean with all the good qualities of old Kentucky Wonder. Lb. 35c, 2 lbs. 60c.



Pole Beans in Garden.

- King Horticultural.** Early and productive. A greatly improved Pole Horticultural. Lb. 30c, 2 lbs. 50c.
- Lazy Wife.** Pods long, stringless and of a rich buttery flavor. Lb. 35c, 2 lbs. 60c.
- Mont d'Or.** A strong, vigorous grower, with pods 6 to 8 ins. long in clusters, thick and fleshy. Lb. 50c, 2 lbs. 90c.
- Runner, Scarlet.** Bright scarlet flowers. Used both as a string and shelled Bean. Lb. 50c, 2 lbs. 90c.
- Runner, White.** Very effective planted with the Scarlet Runner. Lb. 50c, 2 lbs. 90c.

Pole Lima Beans

Lima Beans are very susceptible to cold and wet, and apt to rot in the ground, and should not be planted until all danger of frost is over, and the soil is dry and warm.

- Lima, Carpinteria.** A large-seeded variety of vigorous growth. Pods large and well filled with Beans of excellent flavor. Lb. 40c, 2 lbs. 75c.
- Lima, Dreer's Improved.** An improved Lima, being much thicker than the old Lima and superior in quality. Lb. 40c, 2 lbs. 75c.
- Lima, Early Leviathan.** A very early variety; produces pods in clusters. A splendid variety where the season is short. Lb. 40c, 2 lbs. 75c.
- Lima, King of the Garden.** Early and extremely prolific with large pods bearing five to six beans. Lb. 40c, 2 lbs. 75c.
- Lima, Siebert Early.** An immense yielder and excellent quality. Lb. 40c, 2 lbs. 75c.
- Lima, Sieva or Small.** A popular small-seeded variety, Lb. 35c, 2 lbs. 60c.

CEDAR BEAN POLES, 8 to 10 ft. long, per doz. \$1.80,
per 100 \$14.00.

Broccoli

One ounce will produce about 3500 plants.

This vegetable closely resembles the Cauliflower. A very rich, deep soil is required to grow the Broccoli to perfection, the seed should be sown early in the spring and the plants transplanted into rows 3 feet apart, with 2 feet between the plants.

Early Green Calabrese. A distinct variety forming good sized green heads; this vegetable resembles the Cauliflower with combined Cauliflower and Asparagus flavor. Seed imported. Pkt. 25c, oz. \$1.50, ¼ lb. \$5.00.

White Cape. Heads compact, good size, and of a creamy white. Pkt. 10c, oz. 75c.

Beets

One ounce will sow 50 feet of drill; 5 to 6 lbs. an acre.

A deep, light, sandy loam that has been well enriched is best adapted to the growth of the Beet. Sow in drills from April until July, 16 inches apart and about 1 inch deep; thin the plants about 3 inches apart. The Turnip-rooted are the best, and all early varieties are used extensively for greens.

Crimson Globe. Early, of globe shape, and rich, deep crimson flesh. Pkt. 10c, oz. 20c, ¼ lb. 50c, lb. \$1.25.

Crosby's Egyptian Selected (Arlington Strain), One of the earliest dark-leaved varieties; fine quality. Pkt. 15c, oz. 50c, ¼ lb. \$1.50, lb. \$4.00.

Crosby's Egyptian. One of the earliest dark red varieties; fine quality. Very popular among market gardeners. Pkt. 10c, oz. 20c, ¼ lb. 50c, lb. \$1.25.

Detroit Dark Red. Round and smooth, deep red, very tender. Pkt. 10c, oz. 20c, ¼ lb. 50c, lb. \$1.25.

Dewing's Blood Turnip. Of fine form and flavor; deep red. A desirable variety. Pkt. 10c, oz. 15c, ¼ lb. 40c, lb. \$1.00.

Early Wonder. The most perfect model of an extra early round Beet. The flesh is deep blood-red crimson. It is an ideal all season Beet. Pkt. 10c, oz. 25c, ¼ lb. 75c, lb. \$2.00.

Edmand's. Deep blood-red color, round and smooth, excellent quality; highly recommended. Pkt. 10c, oz. 15c, ¼ lb. 40c, lb. \$1.00.

Grey's Blood Turnip. One of the very best strains for market gardeners; small top, round, handsome and very dark red. Pkt. 15c, oz. 50c, ¼ lb. \$1.50, lb. \$4.00.

Perpetual, or Spinach Beet. Producing green leaves in abundance close to the ground. This variety will give a constant supply of Spinach throughout the season. Pkt. 10c, oz. 20c, ¼ lb. 50c.

Swiss Chard. The leaves are used as Spinach, and the midrib of the leaf, cooked and served up like Asparagus, is delicious. Pkt. 10c, oz. 20c, ¼ lb. 50c.

Swiss Chard, Lucullus. A tall-growing variety, crinkled leaves, tender and of fine flavor. Pkt. 10c, oz. 20c, ¼ lb. 50c.

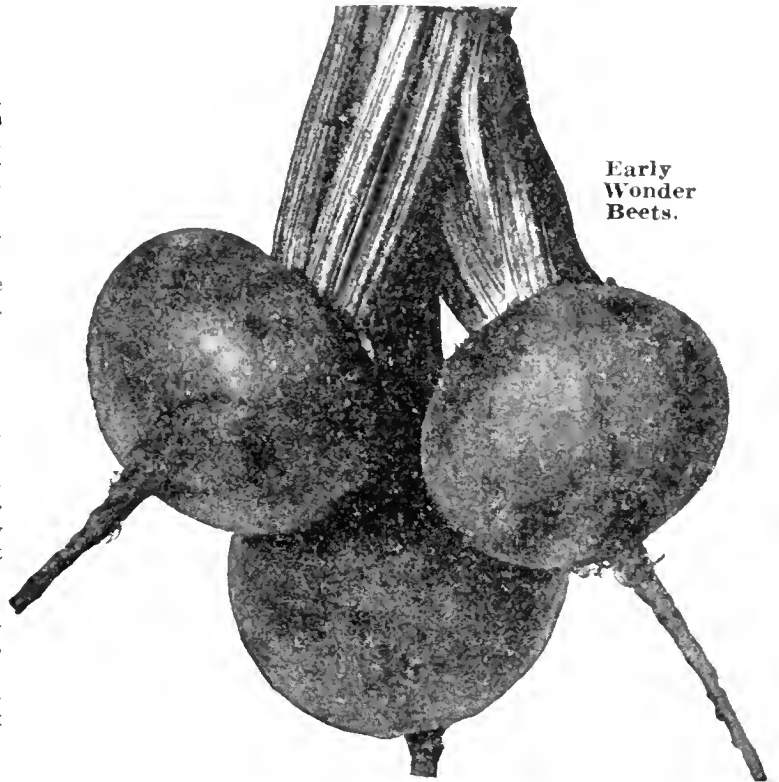

Early Wonder Beets.

Sugar Beet and Mangel Wurzel

Sow in April or May, using 6 to 8 lbs. of seed to the acre.

Danish Sludstrup. Very high yielding. Roots long, oval, orange colored; flesh white with faint yellow tinge. Oz. 10c, ¼ lb. 25c, lb. 75c.

Grey's Prize Long Red Mangel Wurzel. The most largely grown of the Mangels; roots attain an enormous size, producing 30 to 50 tons to the acre; quality superior, the best for deep soil. Oz. 20c, ¼ lb. 60c, lb. \$1.50.

Golden Tankard Mangel Wurzel. The flesh is bright golden yellow; very large, and will produce more Mangels to the acre than any other variety; excellent for feeding stock. Oz. 10c, ¼ lb. 25c, lb. 75c.

Giant Yellow Intermediate Mangel Wurzel. A very large yellow sort, of good quality, and produced in great abundance. Oz. 10c, ¼ lb. 25c, lb. 75c.

Lane's Improved Sugar Beet. Large, hardy, productive and excellent quality. Oz. 10c, ¼ lb. 25c, lb. 75c.

Norbiton Giant Mangel Wurzel. Long red. A valuable variety for deep soil; very productive. Oz. 10c, ¼ lb. 25c, lb. 75c.

Red Globe. Similar to Yellow Globe except in color. Oz. 10c, ¼ lb. 25c, lb. 75c.



Grey's Prize Long Red Mangel Wurzel.

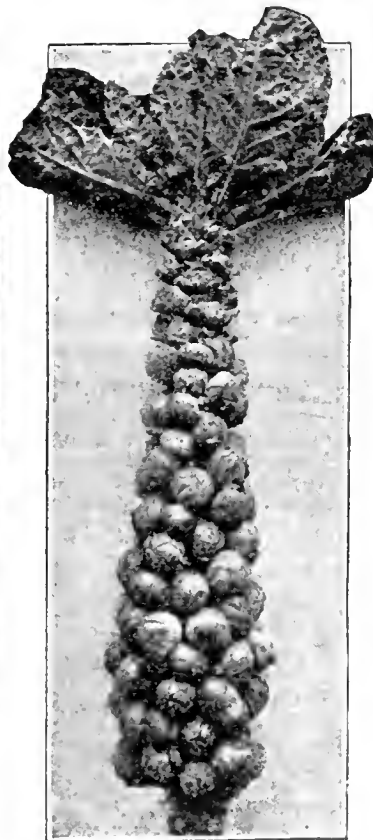

Brussels Sprouts.

Brussels Sprouts

One ounce will produce 2000 plants.

Cultivated for the small heads that grow from the main stem; these small heads are firm and compact, like little Cabbages, and are considered a great delicacy by many people. Cultivate the same as Cabbage or Cauliflower.

Dobbie's Exhibition. Grows tall; is of good quality and very productive. Pkt. 25c, oz. \$1.25.

Improved Dwarf French. Tender and of fine flavor. Pkt. 10c, oz. 50c.

Long Island Improved. Very compact heads, productive. Pkt. 25c, oz. \$1.25.

The Thomas J. Grey Co.'s experience as seedsmen for a period of many years has given them the knowledge of buying seeds and offering to their customers the highest quality of tested seeds for Farm, Garden, and Lawn. Our aim: purity, quality and service. BUY THE BEST.

Cabbage

One ounce produces about 3000 plants.

For early use a sowing may be made in the hotbed in February or March, and for winter use seed should be sown in the open ground in May or June. When the plants are 5 or 6 inches in height, transplant into rows 3 to 3½ feet apart, setting the plants from 2 to 3 feet apart in the rows, according to the variety. A deep, rich, loamy soil is best adapted to the growth of this crop, and if large, fine heads are expected, the land must be prepared by very heavy manuring. A handful of wood ashes thrown into the forming heads will not only keep off the cabbage-fly, but will assist the growth of the plants to a considerable extent. Slug Shot is equally effective.

American Improved Savoy. The favorite curled Savoy Cabbage of finest quality, and an excellent keeper. Pkt. 10c, oz. 35c, ¼ lb. \$1.25.

Autumn King. The heads are of enormous size and very solid. Pkt. 10c, oz. 35c, ¼ lb. \$1.25.

Baby Head Cabbage. The heads are small and of fine quality. We recommend Baby Head Cabbage for greenhouse growing and where space is limited. The seed we offer is grown for us in Denmark. Pkt. 15c, oz. 75c.

Charleston, or Large Wakefield. This strain is about one week later than early Jersey Wakefield. Pkt. 10c, oz. 35c, ¼ lb. \$1.25.

Chinese Wong Bok. This is the famous Chinese Celery Cabbage. It has wide midribs at the base and merges into crisp, tender leaves at the top, the whole being very compact and heavy. It blanches to almost clear white. The culture for Wong Bok is the same as for late Cabbage. Well grown plants should be blanched by tying loosely with burlap. Pkt. 10c, oz. 50c, ¼ lb. \$1.50.

Copenhagen Market. As early as Charleston Wakefield. Very solid. Excellent market sort. Pkt. 10c, oz. 35c, ¼ lb. \$1.25.

Danish Ballhead. A winter Cabbage. Extra hard-headed, of fine quality. Pkt. 10c, oz. 35c, ¼ lb. \$1.25.

Danish Roundhead. A short-stemmed type of the Danish Ballhead, maturing earlier than that variety; excellent quality, large, solid, globe-shaped heads. One of the best winter sorts. Pkt. 10c, oz. 35c, ¼ lb. \$1.25.

Early Summer, Henderson's. A few days later than Wakefield, rather larger and more globe-shaped. Pkt. 10c, oz. 35c, ¼ lb. \$1.25.

Early Jersey Wakefield. One of the most popular early pointed varieties; good grower. Pkt. 10c, oz. 35c, ¼ lb. \$1.25.

Early Wonder Red. The earliest of all red Cabbages. The heads are large, solid and handsome, of delicious flavor, color dark red. Pkt. 10c, oz. 60c.



Copenhagen Market Cabbage.

Fottler's Brunswick. The standard market variety; a drumhead; grows to a large size; solid, tender, good shape and a good keeper. Pkt. 10c, oz. 35c, ¼ lb. \$1.25.

Globe Curled Savoy. A variety with finely curled leaves and of delicate flavor; used for fall crop or for winter. Pkt. 10c, oz. 50c, ¼ lb. \$1.50.

Golden Acre. A new Cabbage, head measuring 9 in. in diameter; 10 days earlier than Copenhagen Market and more compact. Pkt. 10c, oz. 35c, ¼ lb. \$1.25.

Mammoth Red Rock. The largest and surest heading Red Cabbage; heads as large and solid as Flat Dutch and fine grained. Pkt. 10c, oz. 35c, ¼ lb. \$1.25.

Penn State Ballhead. A large somewhat flattened form of the Ballhead, producing probably the largest tonnage per acre of any known variety. This is one of the best winter varieties. Pkt. 15c, oz. 75c, ¼ lb. \$2.50.

Red Dutch Pickling. Used extensively for pickling; tender, medium size. Pkt. 10c, oz. 35c, ¼ lb. \$1.25.

Stone Mason. Select strain. One of the oldest and best known varieties; large size; drumhead; grown principally as a late Cabbage, and for winter keeping. Pkt. 10c, oz. 50c, ¼ lb. \$1.50.

Cabbage Plants. See page 62.

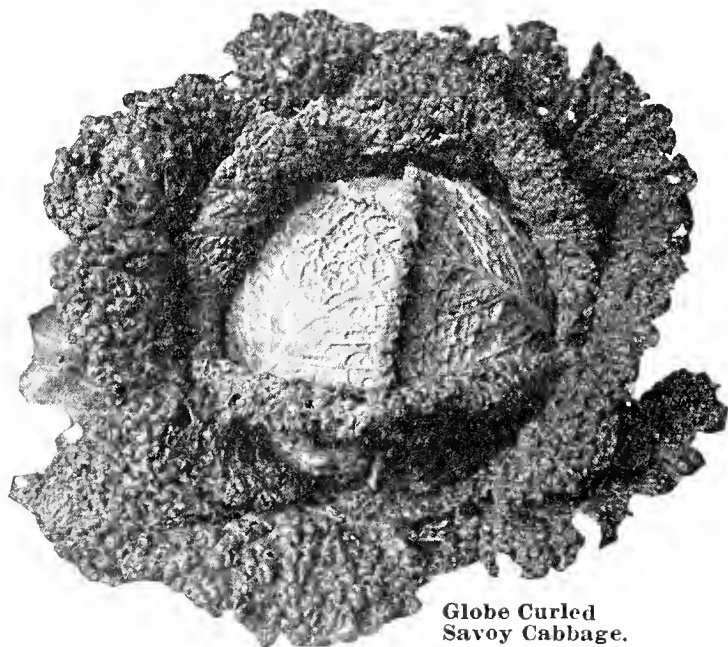

Globe Curled Savoy Cabbage.

SUGGESTIONS FOR SOIL IMPROVEMENT

When animal manure is not available, cover-crops can be sown and plowed or dug under when green, thereby adding humus to the soil. This method of improving the soil can be used in either small or large areas, and we suggest the following varieties for this purpose, to be sown either alone or in combination:

	Quantity per acre	Quantity per
Spring Seeding	if sown alone	1000 sq. ft.
Crimson Clover	20 lbs., \$5.00	1 lb., 20c
Sweet Clover	20 lbs., 3.00	1 lb., 15c
Spring Vetch	1½ bus., 9.00	3 lbs., 60c
Field Peas,		
White Canada	3 bus., 15.00	5 lbs., 50c
Summer Seeding		
Cowpeas,		
Whippoorwill	2 bus., 8.00	3 qts., 75c
Buckwheat,		
Japanese	1 bu., 3.00	3 qts., 60c
September Seeding		
Winter Rye	1½ bus., 3.00	2 qts., 40c
Winter or		
Hairy Vetch	1 bu., 10.00	3 lbs., 85c

Carrot

One ounce will sow 100 feet of drill, 3 lbs. required for one acre.

The Carrot flourishes best in a good, light, well enriched loam. The early, small-sized varieties may be sown in drills 10 inches apart, but the larger sorts require at least 18 inches between the rows; cover about ½ inch deep, and when the plants are well up, thin to 3 to 4 inches apart. As an agricultural root, the Carrot is unsurpassed for feeding stock.

We furnish packets of all varieties of Carrots at 10c each, postpaid, except where noted.

Amsterdam Forcing (Coreless). the roots are a bright salmon-red color, blunt ended and small tap-root, the flesh is crisp, sweet, and extremely fine grained. Pkt. 10c, oz. 25c, ¼ lb. 75c.

Chantenay, Morse's Red Cored. Excellent medium early, half long, stump rooted variety. An excellent table Carrot. Pkt. 10c, oz. 25c, ¼ lb. 75c.

Danvers Half-Long. The best variety for general crop; is of rich color and a good keeper. Pkt. 10c, oz. 20c, ¼ lb. 60c, lb. \$1.50.

Danvers Half-long Improved, Special Strain. Grown for us by a leading Carrot specialist. Pkt. 15c, oz. 50c, ¼ lb. \$1.50.

Earliest French Forcing. The earliest variety and good for forcing under glass. Pkt. 10c, oz. 25c, ¼ lb. 75c.

Early Scarlet Horn. A medium sized root, half long, of fine color. Pkt. 10c, oz. 20c, ¼ lb. 60c, lb. \$1.50.

Guerande or Oxheart. Intermediate length, 3 to 5 in. in diameter; fine quality. Pkt. 10c, oz. 20c, ¼ lb. 60c, lb. \$1.50.

Hutchinson Strain. A very fine Carrot, 8 to 9 in. long, nearly the same size the whole length and stump-rooted. Color deep orange and of fine quality. Pkt. 10c, oz. 50c, ¼ lb. \$1.50.

Half-long Scarlet Nantes. A stump-rooted variety of fine color. Pkt. 10c, oz. 20c, ¼ lb. 60c, lb. \$1.50.

Imperator. An outstanding variety, the roots average about 8 inches long, the flesh is of a rich orange color, fine grained, tender, and of fine quality. Pkt. 10c, oz. 25c, ¼ lb. 75c, lb. \$2.25.

Improved Long Orange. Excellent for stock or table use; roots deep orange. 12 to 15 in. Pkt. 10c, oz. 20c, ¼ lb. 60c, lb. \$1.50.

James' Intermediate. The best intermediate variety tapering to a point; small core and of fine flavor. Pkt. 10c, oz. 20c, ¼ lb. 60c, lb. \$1.50.

Pride of Denmark. A wonderfully fine Carrot 8 to 9 inches long and 2 to 3 inches in diameter, being practically the same size the whole length. It closely resembles the Hutchinson, but has less core and deeper color. Pkt. 15c, oz. 50c, ¼ lb. \$1.50.

Cauliflower

One ounce will produce 3000 plants.

The Cauliflower, like the Cabbage, requires a deep, rich soil. Sow the seed in the hotbed in March and transplant into the garden in May; set the plants in rows and cultivate the same as Cabbage.

Danish Perfection. A very early variety of the Dwarf Erfurt type. All the heads mature at the same time, making it possible to clear the ground at one cutting. Pkt. 25c, oz. \$5.00.

Early Snowball, Grey's Selected. This strain has given excellent satisfaction during the many years we have sold it, and we believe no better strain can be found. Pkt. 25c, oz. \$5.00, ¼ lb. \$14.00.

Earliest Dwarf Erfurt. One of the earliest varieties; very dwarf, with large, white, compact heads of finest quality. Excellent for forcing. Pkt. 25c, oz. \$5.00, ¼ lb. \$14.00.

Early Dwarf Danish, or Dry Weather. A choice strain that comes to maturity very evenly; a favorite for first crop with many growers. Pkt. 25c, oz. \$5.00, ¼ lb. \$14.00.

Veltech's Autumn Giant. Heads very large, white and compact; well protected by foliage; will remain suitable for use a long time. Pkt. 10c, oz. \$1.00, ¼ lb. \$2.50.

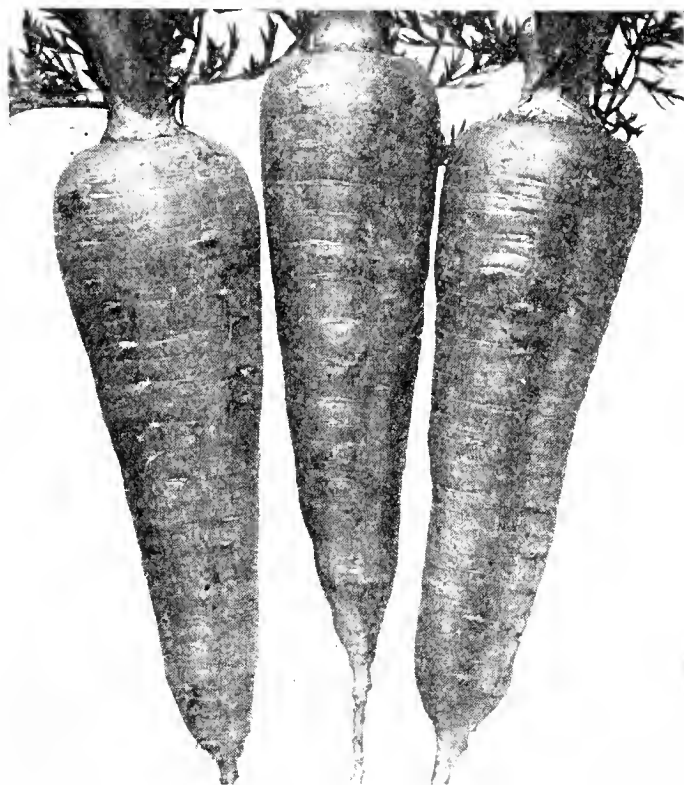

Danvers Half-Long Improved Special Strain Carrots.

Cardoon

Large Smooth. A tender and richly flavored variety which blanches easily. Pkt. 10c, oz. 50c, ¼ lb. \$1.50.

Chervil

Curled Chervil. Cultivated like Parsley. The young leaves are used as a substitute for coffee. Pkt. 10c, oz. 25c, ¼ lb. 75c.

See Endive, page 50.

Chicory

Large-rooted Madgeburg. Roots when dried and roasted are used as a substitute for coffee. Pkt. 10c, oz. 25c, ¼ lb. 75c.

Witloof, or French Endive. This grows in a solid oblong head and blanches ivory white. One of the choicest of all winter salads. Pkt. 10c, oz. 40c, ¼ lb. \$1.25.

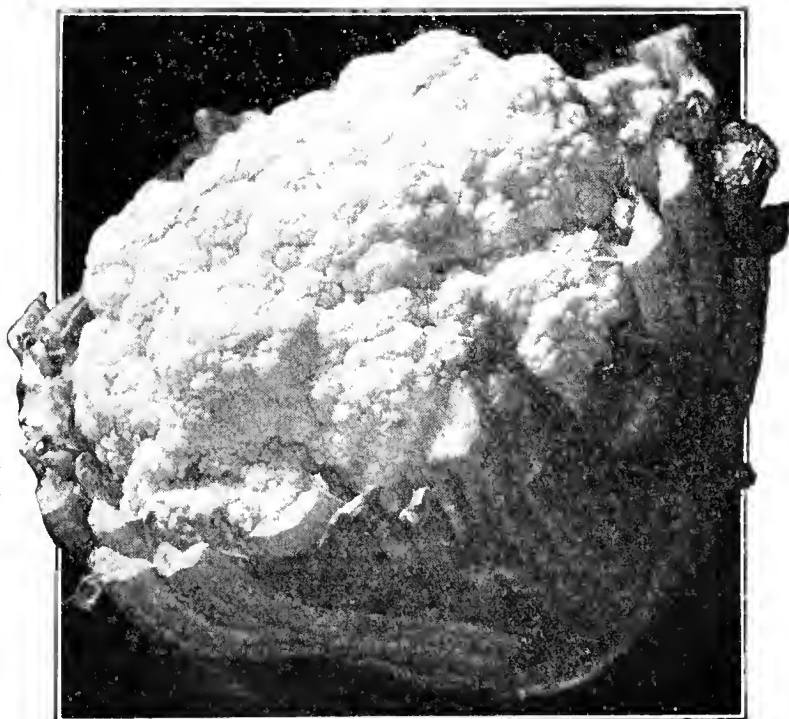

Grey's Selected Early Snowball Cauliflower.

Celery

One ounce will produce about 4000 plants.

Sow the seeds in March or April in a hotbed or cold-frame. As soon as the plants are 3 inches high, transplant into a prepared border, setting them 4 inches apart. When grown 6 inches, and fine stocky plants, set in richly manured deep soil, in rows 3½ feet apart and about 9 inches from plant to plant.

Boston Market. (Selected Strain.) The finest flavored variety in cultivation; solid, crisp and of excellent nutty flavor; dwarf, branching habit; blanches perfectly white; a splendid keeper. Pkt. 25c, oz. \$1.00.

Carter's Dwarf Crimson. Crisp, tender and delicious; a good keeper. Pkt. 25c, oz. \$1.50.

Celeriac or Turnip-rooted Celery, Giant Smooth Prague. Turnip-shaped roots; cultivated as Celery. Pkt. 10c, oz. 50c, ¼ lb. \$1.50.

Easy Blanching. The plants make a rapid and vigorous growth, producing rather thick, solid stalks of excellent quality and rich, nutty flavor. Pkt. 15c, oz. \$1.50.

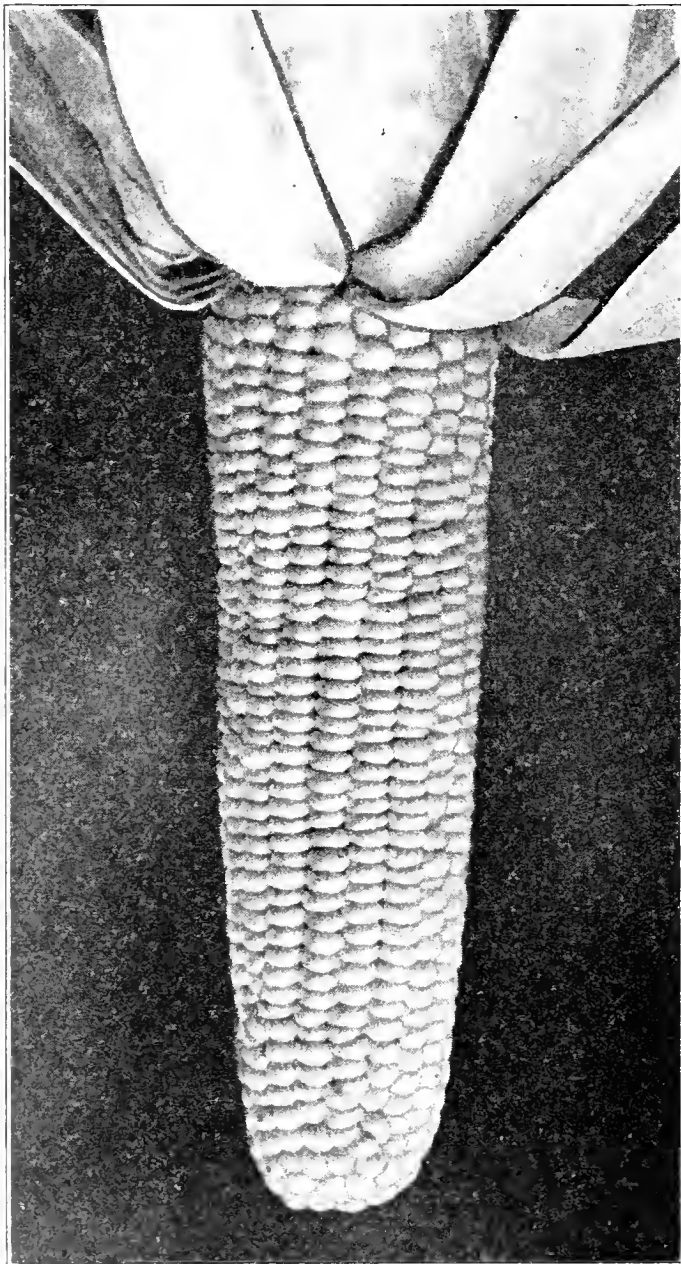

Stowell's Evergreen, Platt's Strain.

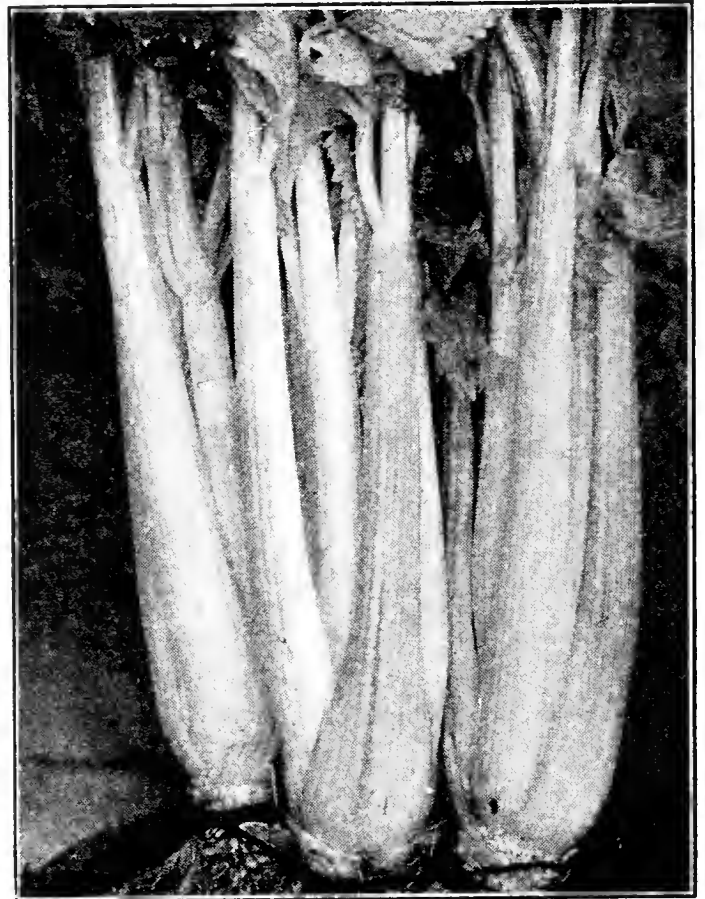

Golden Self-Blanching Celery.

Giant Pascal (Arlington Strain). A valuable variety for both second early and winter use. Pkt. 10c, oz. 50c, ¼ lb. \$1.75.

Golden Plume. The plants are of strong growth and produce thick and heavy stalks of excellent crisp and nutty flavor. Pkt. 10c, oz. \$1.00, ¼ lb. \$3.50.

Newark Market. Green, easy blanching variety; stalks large, solid, crisp and tender; a good keeper and will blanch in cold storage. Pkt. 15c, oz. \$1.50.

Paris Golden. The plant blanches quickly to a beautiful golden yellow; the stalks are brittle and have a fine, nutty flavor. Pkt. 10c, oz. \$1.00, ¼ lb. \$3.00.

White Plume. Ornamental; stalks and portions of leaves are naturally white. Pkt. 10c, oz. 50c, ¼ lb. \$1.75.

Winter Queen. This is one of the finest dwarf winter Celeries. Pkt. 10c, oz. 50c.

CORN, Sweet or Sugar

One pound of corn will plant 100 feet of drill or 150 hills; 12 lbs. to the acre.

We furnish 15c packages of all varieties of Sweet Corn except where noted.

Free Delivery. We will prepay Parcel Post charges on cash orders at quoted catalogue prices on Corn, up to two pounds, anywhere in the United States, east of the Mississippi River; for larger quantities, the purchaser pays transportation charges.

Plant in hills 3 feet apart each way, dropping five or six kernels in each hill, or plant in rows 3 to 4 feet apart, and thin the plants out to 8 or 9 inches in row.

Bantam Evergreen Corn. A yellow variety maturing about 10 days after the Golden Bantam and a week earlier than the Stowell's Evergreen white. It has an ear three times the size of Golden Bantam. Lb. 30c, 2 lbs. 50c, 12 lbs. \$2.50.

Black Mexican. A medium early variety, very sweet, tender, and of delicious flavor. Lb. 30c, 2 lbs. 50c.

Sweet Corn—Continued

Country Gentleman. Cob small, with deep kernels of pearly whiteness; quality delicious. Lb. 25c, 2 lbs. 40c, 12 lbs. \$2.25.

Early Crosby. A popular variety; early, good size and quick growth; white kernels and one of the best. Lb. 25c, 2 lbs. 40c, 12 lbs. \$2.25.

Early Golden Improved. Sweet, tender and delicious. Ears large, 10- to 12-rowed, rich golden yellow color. New England grown. Lb. 30c, 2 lbs. 50c, 12 lbs. \$2.50.

Golden Bantam. Early, sweet and tender. Smaller than Early Golden; 8-rowed. A favorite variety. Lb. 30c, 2 lbs. 50c, 12 lbs. \$2.50.

Golden Cross Bantam. Ears 7 to 8 inches long, 10 to 14-rowed. Slightly lighter yellow than Golden Bantam. Sweet and of fine flavor. Lb. 60c, 2 lbs. \$1.00.

Golden Giant. With its 12- to 16-rowed ears and deep golden yellow kernels it is the most desirable yellow sweet Corn yet introduced. Lb. 35c, 2 lbs. 60c, 12 lbs. \$3.00.

Golden Sunshine. The earliest of the Golden Bantam type. Ears 6½ inches long, containing 12 rows of broad, yellow, sweet grains; especially desirable for its extreme earliness. Lb. 30c, 2 lbs. 50c, 12 lbs. \$2.50.

Grey's Miniature White Corn. This extra early variety requires very little garden space, and may be grown successfully in the greenhouse. Grows about 30 inches high; ears 3 to 4 inches long, of fine quality and very sweet. Supply limited. Pkt. 35c, ¼ lb. 60c, lb. \$2.00.

Mayflower, Early. Matures one week in advance of White Cory. Growth of stalk 4½ to 5 ft., 8 to 12 rows of kernels; large ear. Lb. 30c, 2 lbs. 50c, 12 lbs. \$2.50.

Peep o' Day. This Corn has two valuable points—extraordinary earliness and sweetness. Lb. 30c, 2 lbs. 50c, 12 lbs. \$2.50.

Pocahontas. One of the earliest varieties in cultivation; ears large and very productive; of fine quality. Lb. 30c, 2 lbs. 50c, 12 lbs. \$2.50.

Potter's Excelsior or Squantum. Medium late, 12-rowed ears of excellent quality. Lb. 30c, 2 lbs. 50c, 12 lbs. \$2.50.

Spanish Gold. Grows from 5 to 6 ft. high. Ripens early and has much of the tenderness and flavor of Golden Bantam. Lb. 30c, 2 lbs. 50c, 12 lbs. \$2.50.

Stowell's Evergreen, Special Strain. This Corn specially adapted for New England. The kernels are long and narrow, 18- to 22-rowed. Lb. 25c, 2 lbs. 40c, 12 lbs. \$2.25.

Whipple's Yellow Sweet Corn. This Corn is earlier than Bantam and as large as Evergreen. The ears are very large, 8 to 9 inches long, having 14 to 18 rows of deep kernels. Lb. 30c, 2 lbs. 50c, 12 lbs. \$2.50.

Corn, Field and Fodder. See page 66.

Cucumber

One ounce will plant about 50 hills, 2 to 3 pounds an acre.

For very early use seed may be started in heat and the plants set out in May. For main crop, plant in hills 4 feet apart, in the end of May. Make the hills rich with well rotted manure, and keep the young plants safe from the striped bug by dusting with plaster, or powdered hellebore. Leave four strong plants to each hill.

Arlington White Spine. One of the finest Cucumbers for forcing and one of the most perfect in shape, size, color and quality, and is very brittle and crisp. Pkt. 10c, oz. 25c, ¼ lb. 75c.

Boston Pickling. The best pickling variety yet introduced; very productive. Pkt. 10c, oz. 25c, ¼ lb. 75c.

Davis Perfect. Highly recommended; dark, rich green in color, crisp and tender. Pkt. 10c, oz. 25c, ¼ lb. 75c.

Fordhook Famous. Largest of the White Spine family; fruit long, thick, and tapering at both ends, crisp and solid; a fine slicing sort; color light green. Pkt. 10c, oz. 25c, ¼ lb. 75c.

Grey's A-1. This variety, unlike most other sorts, succeeds equally well in the garden or in the greenhouse; the vines are exceptionally healthy and productive. The fruits will average 12 to 14 inches in length by 2½ inches in diameter and are very symmetrical; the color a very dark green. Pkt. 50c, oz. \$3.50.

Improved White Spine. The best variety for table use or for market; retains its color a long time after being picked; very productive. Pkt. 10c, oz. 25c, ¼ lb. 75c.

Japanese Climbing. Fruit about 10 inches long; thick and of fine flavor. Skin dark green, flesh pure white; can be grown on trellises and fences. Pkt. 10c, oz. 25c, ¼ lb. 75c.

Long Green. Prickly; firm, crisp, dark green; excellent table variety. Pkt. 10c, oz. 25c, ¼ lb. 75c.

West India Gherkin. Used for pickling purposes; a small, oval-shape variety; has the appearance of a bur. Pkt. 10c, oz. 25c, ¼ lb. 75c.

Woodruff's Hybrid. One of the best of the White Spines for market. Grows 8 to 10 inches long and stays green a long time. We have a very fine strain of this Cucumber. Pkt. 10c, oz. 25c, ¼ lb. 75c.

ENGLISH FRAME VARIETIES

The following are excellent varieties for growing in forcing houses.

Delleacy (Sutton's). Fruits dark green, slightly ribbed, ideal form and fine flavor. Pkt. 50c.

Every-day (Sutton's). Fruits of good length, color deep green, almost smooth. Pkt. 50c.

King George (Sutton's). Fruits are unusually handsome and perfect in form. Pkt. 50c.

Matchless (Sutton's). Fruits smooth, dark in color and of the highest quality. Pkt. 50c.

Roehford's Market. A well-known variety; heavy cropper. Pkt. 50c.

Satisfaction (Sutton's). Fruit large, straight, dark green, flavor excellent. Pkt. 50c.

Telegraph Improved (Sutton's). Fruit handsome with very small neck; very prolific. Pkt. 50c.

Tender and True. A well known variety, heavy cropper. Pkt. 50c.



Arlington White Spine Cucumber.

SEMESAN. Place a little Semesan with seeds in a jar and shake vigorously; bacteria and fungus spores adhering to seeds will be killed. 2 ozs. 50c, lb. \$2.50, 5 lbs. \$11.75.

Chives

Seed. Pkt. 25c, oz. 75c.

Roots. 30c per clump, 12 clumps \$3.00. By mail, add 10c extra for each clump.

Collards

Georgia, Southern, or Creole. This vegetable develops a loose-leaved head. It grows 2 or 3 feet high and produces large, light green leaves on rather long stems. A frost, if not too severe, will improve the crop. Pkt. 10c, oz. 20c, ¼ lb. 60c, lb. \$1.50.

Corn Salad or Fetticus

One ounce will sow 100 feet of drill.

This excellent salad may be had the year round. Sow in September, in drills 8 inches apart, covering the seeds lightly to protect from frost by a light covering of hay or litter. The seed may also be sown in spring.

Large-seeded. The most popular variety grown. Pkt. 10c, oz. 25c, ¼ lb. 75c.

Cress or Pepper Grass

One ounce will sow 100 feet of drill.

A popular salad, which should be sown early in spring—very thickly in shallow drills—and at short intervals, for succession, as it soon runs to seed.

Extra Curled. The best variety grown; leaves are beautifully cut and curled; highly prized for garnishing. Pkt. 10c, oz. 20c, ¼ lb. 40c, lb. \$1.25.

Water. This wholesome salad may be grown in any moist situation. Plants should be set not less than a foot apart. The Cress is fit for gathering the second year. Pkt. 10c, oz. 75c, ¼ lb. \$2.25, lb. \$7.00.

Kohlrabi

One ounce will sow 200 feet of drill.

The seed may be sown in June in rows 18 inches apart, and the plants thinned out to 8 or 10 inches.

Purple Vienna. Similar to the following, except in color. Pkt. 10c, oz. 35c, ¼ lb. \$1.25.

White Vienna. The earliest and best table or market variety. Pkt. 10c, oz. 35c, ¼ lb. \$1.25.

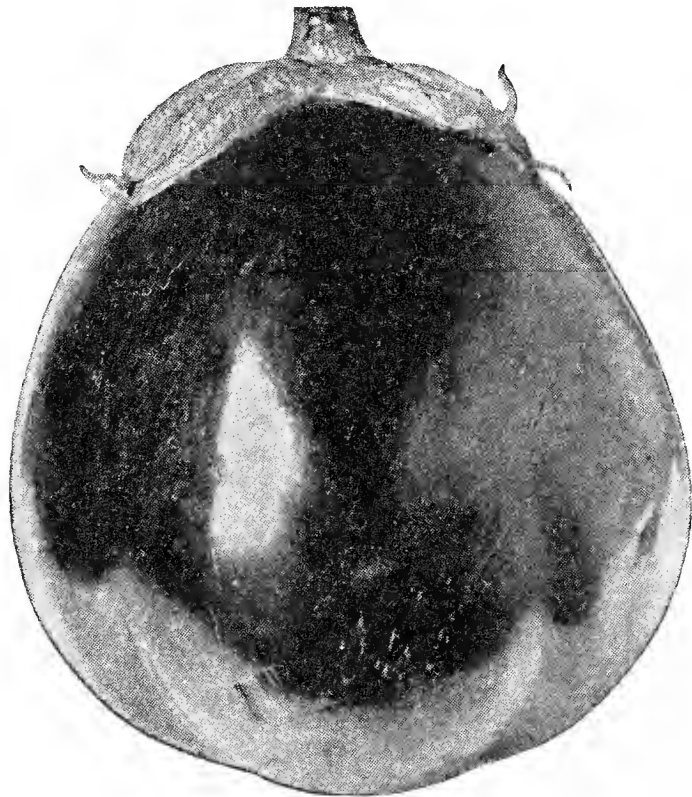

Black Beauty Eggplant.

Dandelion

One ounce will sow 200 feet of drill; 2 lbs. will sow an acre

Sow seed in May or June, in drills ½ inch deep and 15 inches apart. Thin the plants to stand 4 inches apart, cultivate during the summer to keep down weeds. Dandelion may be blanched like Endive for salad purposes, or it may be sown later in the season. Plant—cover lightly with salt hay, and the following spring they will be fit for use as early greens, and considered one of the earliest and most healthful spring greens or salads.

American Improved. The finest variety, leaves very numerous, thick in texture and blanch rapidly. Pkt. 25c, oz. \$1.00, ¼ lb. \$3.00.

French Thick Leaf. Unsurpassed in thickness of leaf and deep green color. Pkt. 10c, oz. 50c, ¼ lb. \$1.50.

Eggplant

One ounce will produce about 1500 plants.

Sow in hotbeds very early in spring, and transplant when two inches high into a second bed or into small pots. If that is not done, thin to 4 inches apart. Do not plant out till the weather becomes perfectly settled and warm. Keep plants watered for a few days if the sun is hot when put out. Set out plants 3 feet by 2.

Black Beauty. Very early and as large as New York Improved. Rich purplish black color. Pkt. 10c, oz. 50c.

Black Pekin. Fruit globular, almost black in color, fine grained and delicately flavored. Pkt. 10c, oz. 50c.

Early Long Purple. A very early, hardy and productive variety of good quality. Pkt. 10c, oz. 50c.

New York Improved. A leading market variety; fruit large, oval, very productive. Pkt. 10c, oz. 50c.

Endive

One ounce will sow 200 feet of drill.

A rather moist soil is preferred. Sow early in the spring in drills, 12 inches apart, and thin out the plants to 10 inches apart in the drills as soon as they are large enough to handle.

Broad-leaved Batavian. Leaves broad; light green, and require to be tied up for blanching. Pkt. 10c, oz. 35c, ¼ lb. \$1.00.

Green Curled. A very hardy dark green, closely curled variety, tender and crisp. Pkt. 10c, oz. 35c, ¼ lb. \$1.00.

Moss Curled. Beautifully curled, and when well developed resembles a tuft of moss. Pkt. 10c, oz. 35c, ¼ lb. \$1.00.

Witloof. See Chicory, page 47.

Fennel, Florence or Naples

(Finocchio di Napoli)

Sow in spring in rows 16 to 20 inches apart and thin to 5 or 6 inches apart. Water freely. Pkt. 10c, oz. 50c.

Garlic

The bulbs are set out like Onion sets, about 4 inches apart in the row, divided into "cloves" or flakes and covered 2 inches deep. Lb. 60c.

Horseradish Sets

Maliner Kren. A variety producing very large, pure white roots. Strong sets. Doz. 35c, 100 \$1.75.

Kale or Borecole

One ounce will produce about 3500 plants.

Early plants may be started in the hotbed, or the seeds may be sown in the open ground in April or May; transplant in June, into rows, and cultivate the same as Cabbage. Sea Kale should be blanched either under large pots or by banking up with sand.

Dwarf Green Curled. One of the best; very hardy and improved by a moderate frost. Pkt. 10c, oz. 25c, ¼ lb. 75c.

Winter, or Siberian Greens (Sprouts). Sow in August or early in September in rows 1 foot apart. Pkt. 10c, oz. 25c, ¼ lb. 75c.

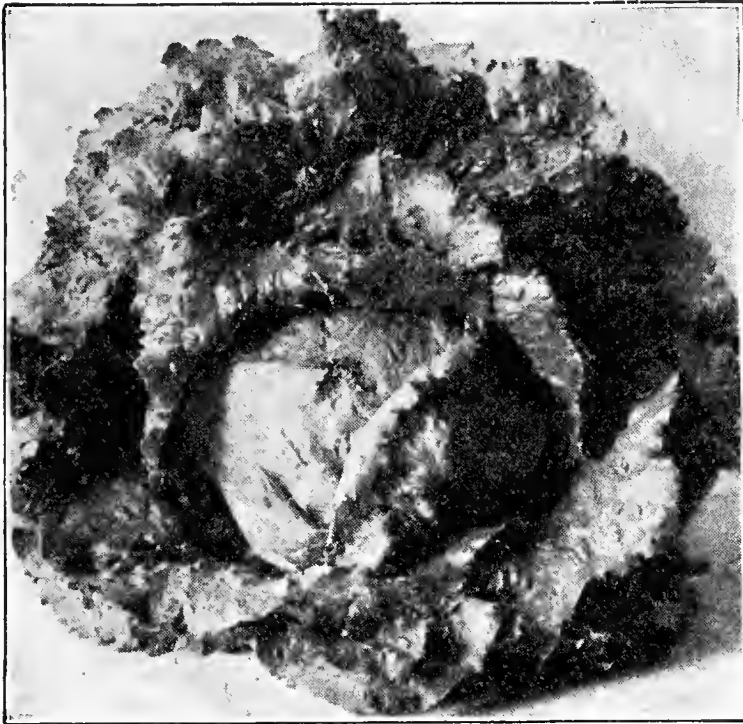

Wonderful or New York.

LETTUCE

One ounce will produce about 3000 plants.

Lettuce succeeds best in rich and comparatively moist soil and is most crisp and tender if grown in cool, moist weather. The more rapidly the plants are grown, the more tender and brittle will be their quality. For early use, sow under glass in February or March, and transplant into a previously prepared hotbed; rows at least 12 inches apart, according to the varieties. Sowing may be made in the open ground as soon as all danger from frost is over; if a continuous supply is desired during season, make sowings every two or three weeks until September.

All the Year Round. A valuable variety, with compact, close heads. Pkt. 10c, oz. 40c, ¼ lb. \$1.25.

Big Boston. A most desirable variety either for forcing or open ground planting. Pkt. 10c, oz. 40c, ¼ lb. \$1.25.

Boston Curled. A variety highly esteemed for earliness and beauty of form. Pkt. 10c, oz. 40c, ¼ lb. \$1.25.

Black Seeded Mammoth Butter. The largest and considered by many the best variety for the late crop. Produces enormous formed heads of the finest quality. Pkt. 10c, oz. 40c, ¼ lb. \$1.25.

Deacon. Splendid variety for standing summer heat; large, solid heads, tender, crisp and sweet. Pkt. 10c, oz. 40c, ¼ lb. \$1.25.

French, Unrivaled. Suitable for growing at any season. A sure heading variety, forming large, compact heads, and slow to run to seed. Similar to Big Boston, being lighter green in color and not tinged with brown. Pkt. 10c, oz. 40c, ¼ lb. \$1.25.

Giant Crystal Head. Outside leaves curled, with red edges. Heads large and solid. Pkt. 10c, oz. 40c, ¼ lb. \$1.25.

Grand Rapids. Crisp and tender, fine for forcing or outdoor culture. Pkt. 10c, oz. 40c, ¼ lb. \$1.25.

Hanson Improved. A superior, curled heading variety of large size, sweet, tender and crisp. Pkt. 10c, oz. 40c, ¼ lb. \$1.25.

Iceberg. A solid heading large variety of excellent quality. Pkt. 10c, oz. 50c, ¼ lb. \$1.50.

May King. Grows quickly and produces globe-shaped heads which are ten to fourteen days earlier than any other, and which stand a long time before going to seed. Pkt. 10c, oz. 50c, ¼ lb. \$1.50.

May King, Selected Strain. As a Lettuce for greenhouse forcing, this is the best; heads form very quickly, are firm and of fine quality. Pkt. 15c, oz. 75c, ¼ lb. \$2.00.

Mignonette. Very solid and compact and of a distinct russet color. Pkt. 10c, oz. 40c, ¼ lb. \$1.25.

Prize Head. Large, loose heads, tinged with brown. Pkt. 10c, oz. 40c, ¼ lb. \$1.25.

Salamander. Fine compact heads which resist summer heat admirably. Pkt. 10c, oz. 40c, ¼ lb. \$1.25.

Simpson Early Curled. Early variety; good for forcing or open ground. Pkt. 10c, oz. 40c, ¼ lb. \$1.25.

Sutton's Supreme. A fine Lettuce of the Drumhead type, and a marked advance on other varieties of the same class. Attains a large size, with a firm heart, which remains good for a long time before starting seed stems. Leaves prettily edged with red. Pkt. 25c.

Tennis Ball, Black Seeded, Select Strain. A very popular sort for open ground culture; forms a handsome head and is crisp and tender. Pkt. 10c, oz. 50c, ¼ lb. \$1.50.

Tennis Ball, White Seeded. Extensively grown for forcing and heading under glass; heads firm and good size, very white and crisp. Pkt. 10c, oz. 40c, ¼ lb. \$1.25.

"Wayahead." Very early, with large, tightly folded heads; the outer leaves are light green, with the inner head finely blanched to a rich buttery yellow. Pkt. 10c, oz. 40c, ¼ lb. \$1.25.

White Boston. A sure, hard-heading variety, the heart and inner leaves are a rich yellow. It is deliciously flavored, very tender, of splendid quality. Pkt. 10c, oz. 50c, ¼ lb. \$1.50.

Wonderful, or New York Cabbage. One of the largest varieties. Wonderful heat resister; strong grower. Heads solid, crisp and tender. Pkt. 10c, oz. 50c, ¼ lb. \$1.50.

Romaine or Cos Lettuce

Sutton's Little Gem Cos. An entirely distinct Cos Lettuce, and a most valuable dwarf, compact variety. Dark green, small, solid, crisp, slow in running to seed, and of delicious quality. Pkt. 25c, ½ oz. 60c, oz. \$1.00.

Trianon Self-Closing Cos. The finest of the Cos varieties. Leaves long, narrow and erect. Pkt. 10c, oz. 40c, ¼ lb. \$1.25.

Leek

One ounce will sow 100 feet of drill

Sow as early in spring as practicable, in drills 1 inch deep and 1 foot apart. When 6 or 8 inches high, transplant in rows 10 inches apart each way, setting them deep, that the neck, being covered, may be blanched.

Musselburgh, or Scotch. A very large variety of superior quality. Pkt. 10c; oz. 50c, ¼ lb. \$1.25.

Giant Carentan. Large size and extra fine quality. Pkt. 10c, oz. 35c, ¼ lb. \$1.00.

Large Flag Winter. Desirable for market or family use. Pkt. 10c, oz. 35c, ¼ lb. \$1.00.

Large Rouen. Grows to a large size and keeps well. Pkt. 10c, oz. 35c, ¼ lb. \$1.00.

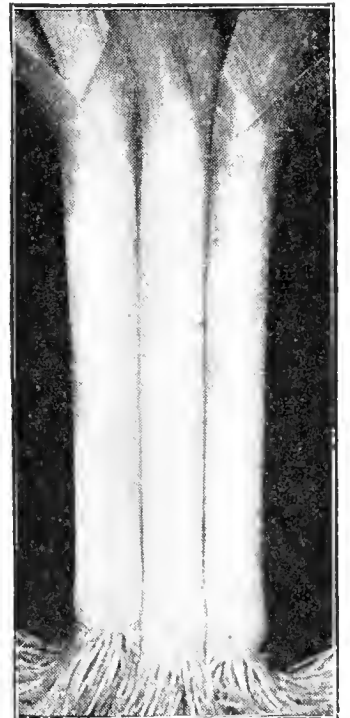

Leek.

Martynia

One ounce will plant 100 hills.

Sow in the open ground in May, and thin out the plants to 2 or 3 feet apart, or a few seeds may be sown in a hotbed and afterward transplanted.

Proboscidea. Pkt. 10c, oz. 50c.

Muskmelon

One ounce will plant 60 hills, two to three pounds for an acre.

Plant in May, six to eight seeds to the hill, and when the plants are well up, thin out to three. Cultivate until the vines cover the ground, and pinch the ends of the growing shoots to induce early fruiting.

Green and Yellow Fleshed Varieties

Arlington Nutmeg. Deep green, finely netted, flesh greenish yellow; rich and sugary. Pkt. 10c, oz. 25c, ¼ lb. 75c.

Extra Early Hackensack. Large size, round shape, deeply ribbed, roughly netted; flesh green, very sweet, and highly flavored. Pkt. 10c, oz. 25c, ¼ lb. 75c.

Honey Ball. Very productive; fruits globular; 5 in. diameter; yellowish white; smooth; sparsely netted. Flesh silvery green; juicy, with sweet honeylike flavor. Pkt. 10c, oz. 25c, ¼ lb. 75c.

Miller's Cream. Nearly round, light green netted skin, with yellow flesh. Quality good. Pkt. 10c, oz. 25c, ¼ lb. 75c.

Rocky Ford. One of the best varieties. Flesh thick and green; sweet and luscious. Pkt. 10c, oz. 25c, ¼ lb. 75c.

Red or Salmon Fleshed Varieties

Bender's Surprise. It is medium early with deep orange flesh, which is very thick and deliciously sweet. Pkt. 10c, oz. 25c, ¼ lb. 75c.

Emerald Gem. Small, extra early; smooth, ribbed, dark green skin and orange flesh; sweet. Pkt. 10c, oz. 25c, ¼ lb. 75c.

Grey's Selected A-1. Flesh deep orange color, very thick and sweet with a delicious flavor, large size and very productive. Pkt. 25c, oz. \$1.00, ¼ lb. \$3.00.

Hale's Best. An early variety, flesh is very thick and fine grained, deep salmon pink in color and richly flavored. Pkt. 10c, oz. 25c, ¼ lb. 75c.

Hearts of Gold. A splendid small, midseason variety. Flesh very thick, deep salmon color, and of high quality. A good shipping Melon. Pkt. 10c, oz. 25c, ¼ lb. 75c.

Lake Champlain (Golden Champlain). An exceedingly early salmon-fleshed Melon of medium size and fine quality. Pkt. 10c, oz. 25c, ¼ lb. 75c.

Oka. A Montreal Melon originated by a Canadian horticulturist, and is the result of several years selection of the Montreal Market crossed with a red-fleshed variety; sweet and juicy. The color is a beautiful cream, with a bright salmon flesh. Pkt. 25c.

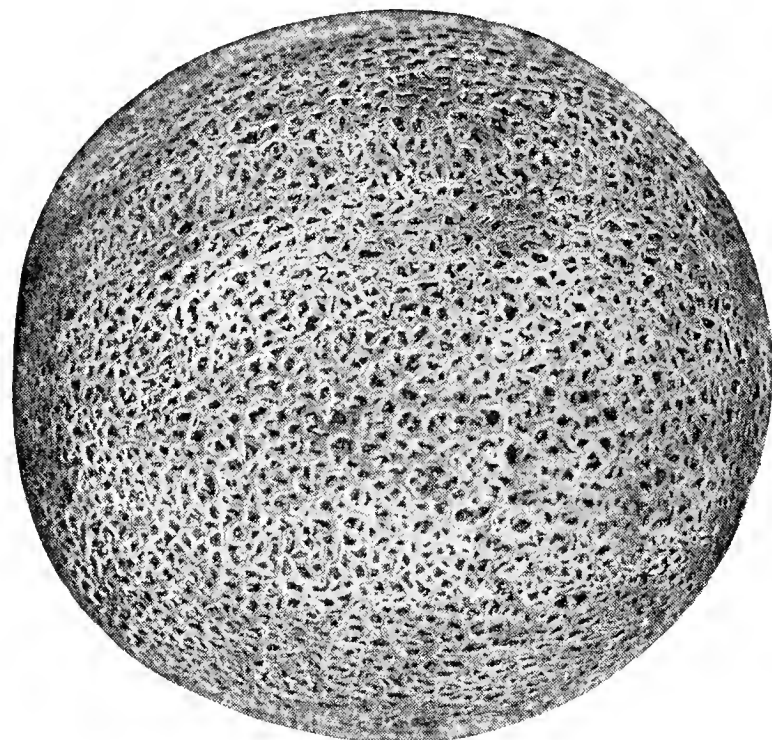

Rocky Ford Muskmelon.

Muskmelons for Forcing

Blenheim Orange. Handsome scarlet flesh, superb flavor. Pkt. 50c.

Cotting's Hybrids. Flesh orange, oval shaped, delicious flavor. Pkt. 50c.

Hero of Lockinge. Fruit handsome, flesh white, extremely rich in flavor. Pkt. 50c.

King George. Scarlet flesh, yellow skin, large, luscious fruits. Pkt. 50c.

Superlative. Flavor exceptionally fine, scarlet flesh, round fruits; very productive. Pkt. 50c.

Sutton's A-1. Rich scarlet flesh, large globular fruits; fine flavor. Pkt. 50c.

Sutton's Universal. Fruits large, flesh is white and very thick; flavor exceptionally fine. Pkt. 50c.

Watermelon

One ounce will plant 30 hills. Four pounds will plant one acre.

Cultivate in the same manner as Muskmelons, but plant 8 to 10 feet apart.

Cole's Early. Very early variety; flesh very deep and sweet; color light green striped. Pkt. 10c, oz. 20c, ¼ lb. 60c.

Colorado Preserving. This is more productive than the common preserving Citron, and larger; the flesh is firm and solid. Pkt. 10c, oz. 20c, ¼ lb. 60c.

Early Fordhook. Extra early, good size, green skin, red flesh. Pkt. 10c, oz. 20c, ¼ lb. 60c.

Mountain Sweet. One of the best for general culture; color dark green, rind thin, flesh scarlet, solid, very sweet and delicious. Pkt. 10c, oz. 20c, ¼ lb. 60c.

Phinney's Early. An early variety, of medium size; red fleshed, quite hardy, and very productive; quality excellent. Pkt. 10c, oz. 20c, ¼ lb. 60c.

Tom Watson. The flesh is rich red color, solid, sweet and luscious and ripens close up to the rind. Pkt. 10c, oz. 20c, ¼ lb. 60c.

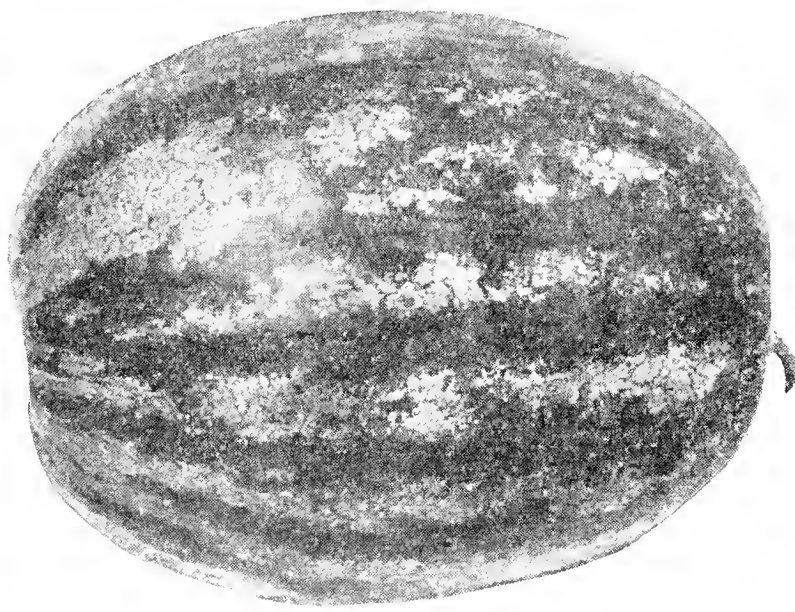

Cole's Early Watermelon.



Mushrooms

One brick of Mushroom Spawn is sufficient for 10 square feet of bed.

For the bed, use a mixture of horse manure and good fresh loam. Before being placed in the bed let the material be thoroughly mixed and well turned three or four times. To prevent violent heating it is good policy to mix thoroughly with the manure, about one fourth its bulk of good loamy soil and oak leaves. In making up the bed, tread it firmly and, if necessary, wet it slightly. Leave it thus for about a week, or till the temperature of the bed has subsided to 85 or 90 degrees. Then make holes about 10 inches apart and put in each a piece of spawn about the size of a walnut. Cover the holes and press the soil solid and smooth. Mushrooms will appear in six or eight weeks from time of spawning. The bed will continue bearing about a month. No mushrooms can develop if the temperature is insufficient; the bed should not be below 80 degrees at time of spawning, and the atmospheric temperature not below 65 degrees.

If wanted by mail, add postage at parcel post rates.

BRICK SPAWN, AMERICAN PURE CULTURE

Ten bricks will spawn 100 square feet (10x10 ft.)

Spores have been selected from specimen Mushrooms and transferred to bricks of compressed manure and loam. Break the brick into pieces the size of a walnut and plant 1 foot apart each way.

Per brick (about 1 1/2 lbs.)	\$0.40
Per 10 bricks	3.50
Per 25 bricks	7.50
Per 100 bricks	30.00

BOTTLE SPAWN

One quart will spawn 35 square feet. In this new method the mushroom spawn is the very best that can be produced. All materials have been sterilized and the spawn grown under absolutely germ-proof conditions. Each unit individually packed and containing complete instructions for the grower.

Quart	\$ 1.25
6 qts.	6.50
12 qts.	12.00

The Book—"Modern Mushroom Culture" by Dr. J. Franklin Styer. It is the most modern, reliable treatise available. \$1.50 a copy.

Mustard

One ounce will sow 50 feet of drill.

Green mustard imparts a delightfully pungent flavor to the various forms of prepared salads. For early crops the seed may be sown in a hotbed in March, and for general crop at frequent intervals through the spring, in drills from 8 to 12 inches apart.

Chinese Broad-leaved. Leaves much larger than the white Mustard. Flavor pleasantly sweet and pungent. Can be cooked like Spinach. Pkt. 10c, oz. 25c, 1/4 lb. 75c, lb. \$2.00.

Fordhook Fancy. Very ornamental. Plants of vigorous growth; cooked same as Spinach. Pkt. 10c, oz. 25c, 1/4 lb. 75c, lb. \$2.00.

White. Much used for salads; the seed is also used medicinally, and as a seasoning for pickles. Pkt. 10c, oz. 25c, 1/4 lb. 75c, lb. \$2.00.



Mustard Spinach

Tendergreen. A variety of greens producing large dark green leaves, fairly smooth, with light green center ribs; slow to seed, resistant to heat and drought; combines the flavor of mustard and spinach. It is ready for table or market in 21 to 25 days after planting. An excellent addition to the list of greens. Pkt. 10c, oz. 25c, 1/4 lb. 75c, lb. \$2.00.

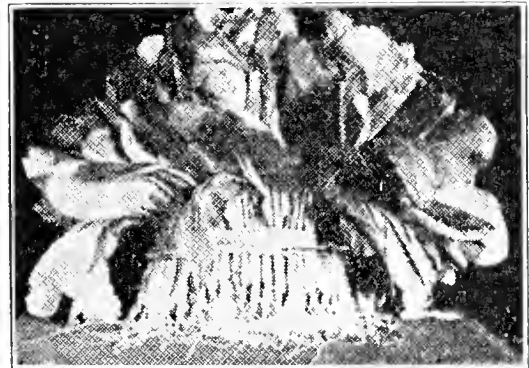

Mustard Spinach.

Okra or Gumbo

One ounce will sow 40 feet of drill.

This plant is extensively cultivated for its green pods, which are used in soups and stews, and are very wholesome and nutritious. Sow about the middle of May, in drills 3 feet apart, and thin out the plants to 1 foot apart.

Improved Dwarf Green. Very early; smooth pods. Pkt. 10c, oz. 20c, 1/4 lb. 60c.

White Velvet, or Creole. Pods smooth, of large size, and a creamy white. Pkt. 10c, oz. 20c, 1/4 lb. 60c.

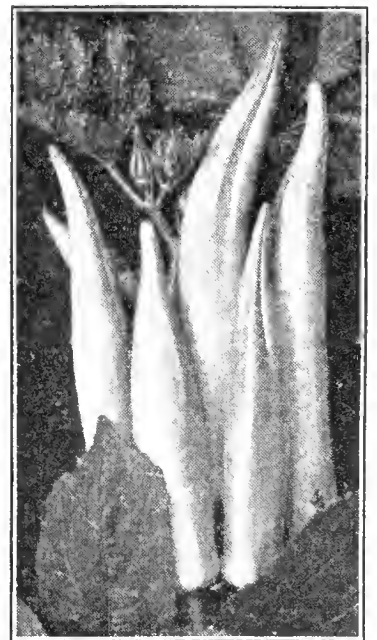

White Velvet Okra.

Standard Mushroom or Hotbed Thermometers

Boxwood, metal tipped. Price \$3.00 each. Thermometers should whenever possible be sent by Express. We do not guarantee safe arrival if forwarded by Parcel Post.

Onions

One ounce will sow 100 feet of drill. Four or five pounds to the acre.

The Onion thrives best in light, loamy, mellow soil; and, unlike most kinds of garden vegetables, succeeds well when cultivated on the same land for successive years. The seed should be sown as early in the spring as the ground is in good working condition, in drills 14 inches apart, and covered $\frac{1}{4}$ inch deep. Keep free from weeds, but be careful not to disturb the growing bulbs. A top dressing of wood ashes, applied after the second weeding, is very beneficial. The Onions will ripen early in September, and after being gathered and exposed to the sun for a few days for drying, they will be ready for storing or the market.

Ailsa Craig. Grows to a large size; very mild flavor; pale yellow. A valuable exhibition variety. Pkt. 25c, oz. \$1.00, $\frac{1}{4}$ lb. \$3.00.

Barletta. A very early, small, pure white variety, flesh firm and mild in flavor. Excellent for pickling. Pkt. 15c, oz. 60c, $\frac{1}{4}$ lb. \$2.00.

Cranston's Excelsior. Handsome globe-shaped variety; large, solid, with small neck; straw color. An exhibition variety. Pkt. 25c, oz. \$1.00.

Danvers Yellow Globe. Selected with the greatest care; the true shape and color; a reliable and sure cropper. Pkt. 10c, oz. 50c, $\frac{1}{4}$ lb. \$1.50.

Danvers Yellow Globe. Selected Strain. The finest type of this popular variety on the market. Pkt. 25c, oz. \$1.00, $\frac{1}{4}$ lb. \$3.00.

Gigantic Gibraltar. A handsome straw-colored Onion of enormous size, possessed of many sterling qualities. Grand for exhibition. Pkt. 25c, oz. \$1.00.

Large Red Wethersfield. The leading red variety of the East; almost round; deep red color; grows to good size and is a good keeper. Pkt. 10c, oz. 50c, $\frac{1}{4}$ lb. \$1.50.

Mammoth Silver King. Of attractive shape, with silvery white skin and flesh of a most agreeable mild flavor. Pkt. 10c, oz. 50c, $\frac{1}{4}$ lb. \$1.50.

Prizetaker. Of a rich straw color and enormous size, averaging 12 to 14 inches in circumference. Although of such great size, it is very hard and an excellent keeper. Pkt. 10c, oz. 50c, $\frac{1}{4}$ lb. \$1.50.

Southport Red Globe. A good late sort. Keeps well. Pkt. 10c, oz. 50c, $\frac{1}{4}$ lb. \$1.50.

Southport Yellow Globe. A fine large variety. Somewhat later than the Danvers. Pkt. 10c, oz. 50c, $\frac{1}{4}$ lb. \$1.50.

Sweet Spanish. A handsome globe-shaped Onion of the largest size, skin light yellow, flesh white and very mild. Eating and keeping qualities excellent. Pkt. 10c, oz. 50c, $\frac{1}{4}$ lb. \$1.50.

The Queen. A handsome silver-skinned variety; esteemed for its rapid growth, mild flavor and fine keeping qualities. Pkt. 10c, oz. 50c, $\frac{1}{4}$ lb. \$1.50.

White Globe. Of mild flavor; skin silvery white; flesh fine grained, good keeper. Pkt. 10c, oz. 50c, $\frac{1}{4}$ lb. \$1.50.

White Portugal, or Silverskin. Bulbs of medium size; flattened; skin silvery white; flesh fine grained and mild flavored. Pkt. 10c, oz. 50c, $\frac{1}{4}$ lb. \$1.50.

Onion Sets

Prices Variable

These are small Onions grown the previous year, ripened off and taken up when mere bulbets. They produce a very early crop, and grow in any good soil. Set them 3 or 4 inches apart in rows 1 foot apart. Potato Onions are generally grown from bulbs grown in clusters which are separated when planted.

If ordered by mail, add postage.

Shallots. Much used in soups, salads, etc. Qt. 50c, 4 qts. \$1.75, pk. \$3.25.

Japanese Yellow Onion Sets. The best variety of yellow sets for earliness, quality and production. Qt. 30c, 4 qts. \$1.00, pk. \$2.00.

Potato Onions, White (Multipliers). Very productive and early and keep remarkably well. Qt. 50c.

Potato Onions, Yellow. A little earlier than the white and yellow sets. Qt. 50c, pk. \$3.25.

White Sets. The best for general use, early, and of fine flavor. Qt. 35c, 4 qts. \$1.25, pk. \$2.25.

Yellow Sets. Preferred by some to white sets. Qt. 30c, 4 qts. \$1.00, pk. \$2.00.

Parsley

One ounce will sow 150 feet of drill.

Parsley succeeds best in rich, mellow soil, and as the seed germinates slowly—sometimes remaining in the earth four or five weeks before the plants appear—the sowing should be made as early in spring as the ground is in working condition. Can also be sown in hotbed in February. When the plants are 2 or 3 inches high, thin them out to 8 or 10 inches apart. The leaves of the curled varieties are used for garnishing, also for flavoring soups and stews.

Double Curled. Dwarf, finely curled; excellent for table and edgings. Pkt. 10c, oz. 25c, $\frac{1}{4}$ lb. 75c.

Dobbie's Exhibition. This Parsley has long been recognized as a standard exhibition sort. It is remarkable for its large, fine leaves and close habit. The seed offered has been saved from selected plants only; every one was a perfect specimen. Pkt. 25c, oz. 75c.

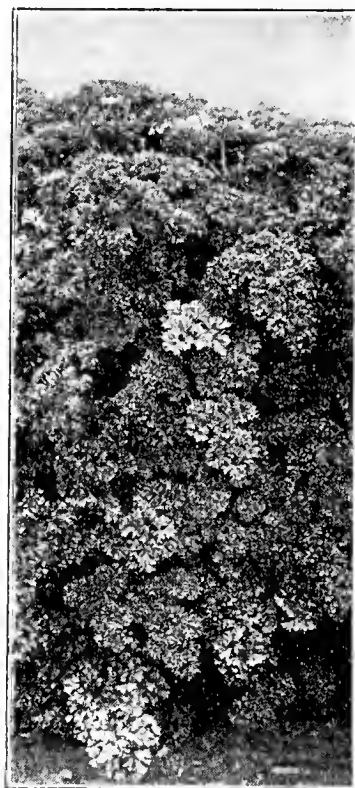

Grey's Perfection Parsley.

Grey's Perfection. Beautifully curled and highly ornamental. Pkt. 25c, oz. 75c.

Hamburg, or Rooted. The roots are used for flavoring. Pkt. 10c, oz. 30c, $\frac{1}{4}$ lb. \$1.00.

Moss Curled. One of the finest varieties for garnishing on account of its mossy appearance and its bright color. Pkt. 10c, oz. 25c, $\frac{1}{4}$ lb. 75c.



Southport Red Globe.

Danvers Yellow Globe.

Red Wethersfield.

PEAS

Two lbs. of peas will plant 100 feet of drill; 90 lbs., to the acre.

Peas succeed best in light, rich soil. The early round, smooth varieties should be planted as early in spring as possible, while the wrinkled sorts, which are more tender, will do better if planted after the ground becomes warmer. Sow in drills, 2 to 3 feet apart, according to variety, and cover early sowing about 2 inches; later plantings should be covered 3 to 4 inches. Successive plantings can be made every ten days up to the middle of July. For the later plantings the early varieties are preferred.

Free Delivery. We will prepay Parcel Post charges on cash orders at quoted catalogue prices on Peas, up to two pounds, anywhere in the United States, east of the Mississippi River; for larger quantities, the purchaser pays transportation charges.

We furnish 20c packages of all kinds of Peas, except where noted

Before planting Peas
inoculate seed with



Alaska or Clipper. A valuable variety either for private use or for market. Pods well filled. 2½ ft. Lb. 25c, 2 lbs. 45c, 7 lbs. \$1.40.

Blue Bantam. A fine extra early wrinkled Pea. Large pods well filled with deep green, fine flavored Peas. Height 2¼ ft. Lb. 30c, 2 lbs. 55c, 7 lbs. \$1.75.

Early Morn. Of Gradus type. Early, with large pods and Peas of good flavor. 3 ft. Lb. 30c, 2 lbs. 55c, 7 lbs. \$1.75.

Gradus. (Prosperity). Large, handsome pods, well filled, ripening with the earliest; pods long, straight, slightly rounded at the point. 3 ft. Lb. 30c, 2 lbs. 55c, 7 lbs. \$1.75.

Grey's Perfection. One of the earliest Peas in cultivation; the pods, which are numerous, contain six or seven good-sized Peas. Very productive and of fine flavor. 2½ ft. Lb. 30c, 2 lbs. 55c, 7 lbs. \$1.75.

Hundredfold. A splendid large-podded dwarf variety; the pods are 4 inches long and well filled with large deep green Peas of fine quality. The vines grow 16 to 18 inches high and very strong. This is one of the best dwarf early Peas for the home garden and market. Lb. 30c, 2 lbs. 55c, 7 lbs. \$1.75.

Laxton's Progress. This is the finest new early dwarf Pea Laxton has ever yet raised; wrinkled, averaging 9 to 10 Peas to a pod. The pods are dark green, height 18 to 24 in. Lb. 30c, 2 lbs. 55c, 7 lbs. \$1.75.

Laxton's Superb. A splendid early semi-wrinkled variety. Hardy and very productive. Pods large and well-filled. Height 18 inches. Lb. 35c, 2 lbs. 60c, 7 lbs. \$2.00.

Laxtonian, Re-Selected. This fine new Pea has been carefully selected, and the stock now offered is saved from deep green, giant pods only. Pods are slightly curved and deep green Peas are of excellent flavor. Lb. 30c, 2 lbs. 55c, 7 lbs. \$1.75.

Little Marvel. This is one of the best dwarf Peas; a heavy cropper and of best quality. Pods green, blunt-ended and well filled. Lb. 30c, 2 lbs. 55c, 7 lbs. \$1.75.

Nott's Excelsior. An improvement on American Wonder, being more vigorous and prolific, with large pods and more Peas. Height 15 in. Lb. 25c, 2 lbs. 40c, 7 lbs. \$1.25.

Pilot. An extra early round-seeded or smooth Pea. Can be planted as soon as ground can be worked. Pods as large as the Gradus. Very prolific, highly recommended as an extra early market sort. Lb. 30c, 2 lbs. 55c, 7 lbs. \$1.75.

Sutton's Pioneer. A first early Pea which has won great popularity for its many excellent qualities. Height about 2 ft. Lb. 30c, 2 lbs. 55c, 7 lbs. \$1.75.

Sutton's Excelsior. An extra early, dwarf, wrinkled Pea, fully as early as the American Wonder, with much broader pods, filled with large Peas of the finest flavor. 1½ ft. Lb. 25c, 2 lbs. 40c, 7 lbs. \$1.25.

Thomas Laxton. One of the best early wrinkled Peas yet introduced; very productive with large, well-filled pods. 3 ft. Lb. 30c, 2 lbs. 55c, 7 lbs. \$1.75.

World's Record. An earlier strain of the well-known Gradus Peas. Medium green, moderately stout vines, bearing medium green pods, 4 inches long, which are fairly broad, pointed and well filled with from 7 to 9 very fine dark green Peas. Lb. 30c, 2 lbs. 55c, 7 lbs. \$1.75.

Second Early and Late Varieties

Alderman. A large-podded wrinkled Pea of robust habit. Pods 4 to 5 inches long, well filled with Peas of excellent flavor. 3½ ft. Lb. 35c, 2 lbs. 60c, 7 lbs. \$2.00.



Gradus Peas.

Admiral Beatty. A new and very popular variety, highly productive and of excellent quality. Height 4 feet, pods large, green, and produced in pairs. Lb. 35c, 2 lbs. 60c, 7 lbs. \$2.00.

Canada Field. See page 66.

Champion of England. A standard variety; very sweet and delicious. One of the best and most popular. 5 ft. Lb. 35c, 2 lbs. 60c, 7 lbs. \$2.00.

Dwarf Telephone. Season medium. Pods long, remarkably well filled, color pale green; peas large, tender and of delicious flavor. 1½ ft. Lb. 30c, 2 lbs. 55c, 7 lbs. \$1.75.

Everbearing Bliss. A continuous bearing variety of especial value for late summer and autumn. Pods 3 to 4 in. long, producing 6 to 8 large wrinkled peas; quality unsurpassed. 2 ft. Lb. 30c, 2 lbs. 55c, 7 lbs. \$1.75.

French Canner (Petit Pois). Very prolific, with long slim, curved pods, containing seven to nine peas. 3 to 3½ ft. Lb. 50c, 2 lbs. 90c, 7 lbs. \$2.75.

Mammoth Meiting Sugar. Best of all the edible-podded Peas. Pods straight, smooth, brittle and delicious. 3 ft. Lb. 40c, 2 lbs. 75c, 7 lbs. \$2.25.

Peas—Continued

Sutton's Super V. C. The largest podded Pea in existence; height from 5 to 6 ft. Large pods of fine flavor, an exhibition variety. Lb. 75c, 2 lbs. \$1.40, 7 lbs. \$4.00.

Onward. Decidedly the best Pea of recent introduction; pods are 4 in. long with 6 to 8 deep green peas of the finest flavor. Lb. 40c, 2 lbs. 75c, 7 lbs. \$2.25.

The Britisher. A prolific, strong growing variety with medium green foliage. Pods are perfectly straight; pointed at the ends, and of a medium green color, containing large, nicely flavored peas. 4 ft. Main crop; wrinkled. Lb. \$1.00, 2 lbs. \$1.75.

Quite Content, Carter. The largest and finest podded Pea in cultivation. Received First Class Certificate from the Royal Horticultural Society of London. A main crop variety; grows 5 feet high; foliage and pod deep green; pods 6 to 7 in. long, hanging mostly in pairs; ten to twelve peas in a pod. Flavor superb. Lb. 40c, 2 lbs. 75c, 7 lbs. \$2.25.

Stratagem. A dwarf, wrinkled, blue marrow; a heavy cropper, and produces large, remarkably well filled pods of excellent flavor. One of the best. 2 ft. Lb. 30c, 2 lbs. 55c, 7 lbs. \$1.75.

Telephone. Immensely productive, of the finest quality and excellent sugary flavor, the pods are of large size and closely packed with large, delicious peas. 4 ft. Lb. 30c, 2 lbs. 55c, 7 lbs. \$1.75.

The Gladstone. One of the best late Peas; immense cropper, long, curved, deep green, well filled pods. 3½ ft. Lb. 40c, 2 lbs. 75c, 7 lbs. \$2.25.

Before planting Peas,
inoculate seed with

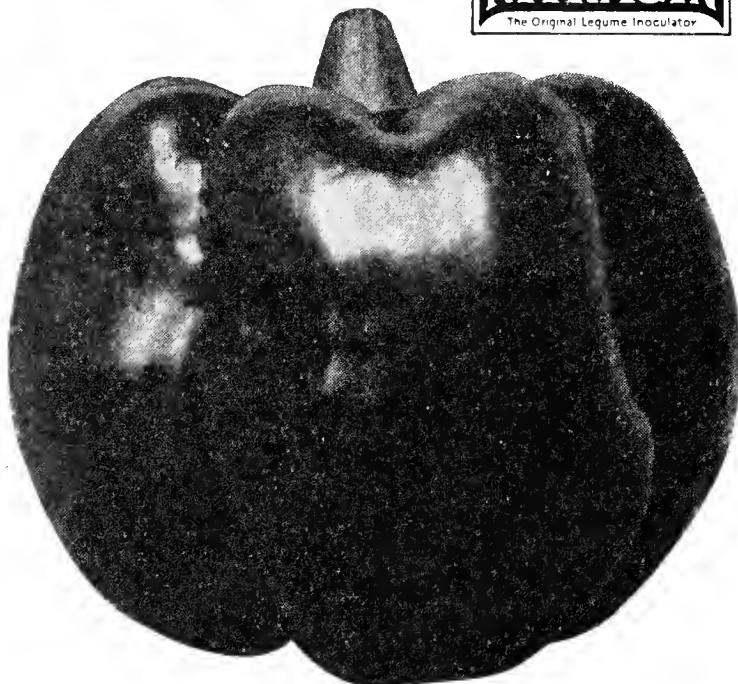

Large Bell or Bull Nose Pepper.

Parsnips

One ounce will sow 100 feet of drill. Five to six pounds to the acre.

Sow in April or early in May, as Parsnips require a long season to mature. Their cultivation is otherwise the same as directed for Carrots. If left in the ground till the following spring, they are very much improved in flavor.

Arlington Long White. A good variety for general use; long and smooth. Pkt. 10c, oz. 25c, ¼ lb. 75c.

Early Round. The earliest variety in cultivation, of good flavor but of small size. Pkt. 10c, oz. 30c, ¼ lb. \$1.00.

Hollow-Crowned. Roots very long, white, smooth and sweet. Excellent flavor. Pkt. 10c, oz. 25c, ¼ lb. 75c.

Student. A favorite English variety; tender and smooth. Pkt. 10c, oz. 30c, ¼ lb. \$1.00.

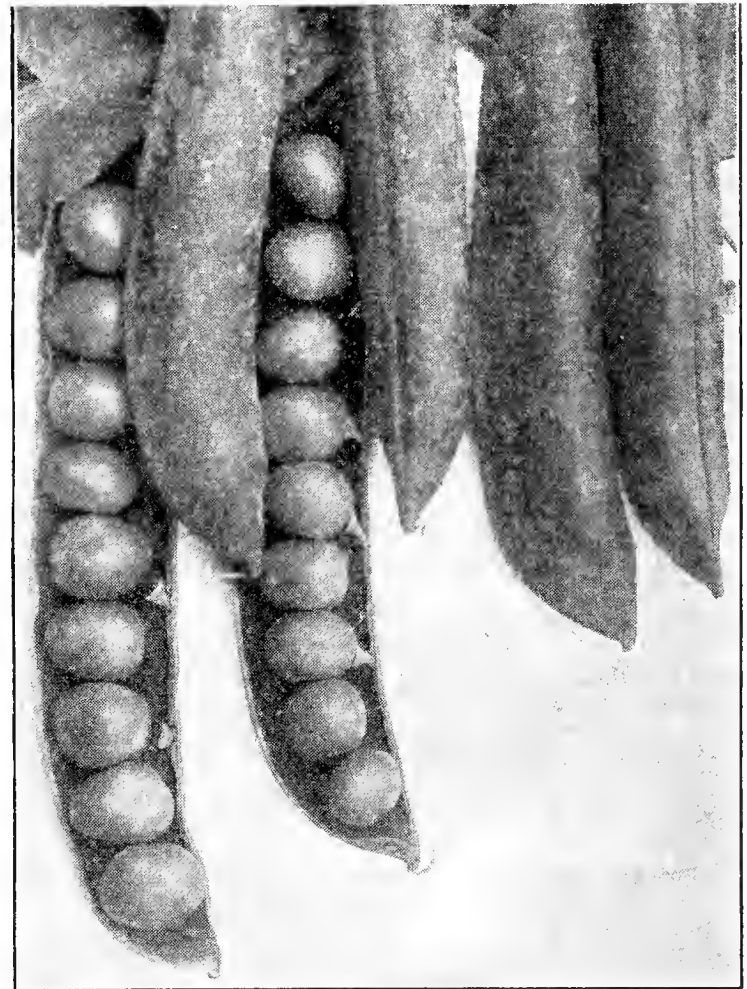

Telephone Peas.

Pepper

One ounce will produce about 1500 plants.

Sow in March or April in a hotbed and transplant into open ground late in May or early in June when the weather has become well settled, as the plants are quite tender. Set in rows about 2 feet apart, and 15 inches apart in the row. A warm, sandy loam is best suited to their growth.

California Wonder. A sweet variety of great merit. Heavily productive over a long season. Fruits very large, smooth and regular. Pkt. 15c, oz. 75c, ¼ lb. \$2.00.

Chinese Giant. Very large, flesh mild and thick. Pkt. 10c, oz. 50c, ¼ lb. \$1.50.

Golden Dawn. A large yellow variety, resembling the Bell in shape. Mild and sweet. Pkt. 10c, oz. 50c, ¼ lb. \$1.50.

Harris Early Giant. The largest Pepper grown; early and prolific. The plants produce enormous yield. The Peppers are 5 in. high and 3½ in. through; deep green turning to brilliant red. Flesh thick and of a very sweet flavor. Pkt. 15c, oz. 60c.

Large Bell, or Bull Nose. Good for Mangoes; early, sweet and less pungent than many; one of the best. Pkt. 10c, oz. 50c, ¼ lb. \$1.50.

Long Red Cayenne. A long, slim pod, rather pointed, and when ripe, of a bright red color, extremely strong and pungent. Pkt. 10c, oz. 50c.

Neapolitan Large Early. The earliest of the large, sweet Peppers. Pkt. 10c, oz. 50c, ¼ lb. \$1.50.

Ruby King. Long, about 5 in.; very thick, fine, mild flavor. Pkt. 10c, oz. 50c, ¼ lb. \$1.50.

Squash. Flesh thick, mild and pleasant to the taste, though more piquant than some. Pkt. 10c, oz. 50c, ¼ lb. \$1.50.

Sunnybrook. The fruit measures 2½ to 3 in. thick and 2 to 2½ in. deep. The skin is smooth and of a deep scarlet color. The flesh is unusually thick and very sweet. Pkt. 10c, oz. 50c, ¼ lb. \$1.50.

Sweet Mountain. Grows to large size; shape somewhat like the Bell, but much larger. Pkt. 10c, oz. 50c, ¼ lb. \$1.50.

Potatoes

Eight to ten bushels will plant one acre.

Owing to unsettled market conditions prices will be given on application.

A good, sandy loam produces the best Potatoes, but they can be grown on all kinds of soil. New or pasture land, with the turf freshly turned, produces the finest crop. Make furrows of good depth, 3 feet apart. Scatter a liberal dressing of phosphate or decayed stable manure along the drill, and set the seed about 10 inches apart in the rows. Cover with about 2 inches of soil, and begin to cultivate when the plants are well up. At each successive hoeing, bring additional soil about the plant. A change of seed is advisable.

Delaware. Tubers large, smooth and of best quality; white and yield well.

Early Ohio. One of the best for early market. A week earlier than Early Rose. Of fine quality.

Early Rose. The well known variety; early and prolific.

Green Mountain. (Certified Stock.) We can recommend this variety as one of the best for all purposes.

Irish Cobbler. (Certified Stock.) Cream white color and of excellent quality. A vigorous grower, early, ripens uniformly, and keeps well.

New Queen. Flesh white and quality good; early and productive. In shape and color it resembles the Beauty of Hebron.

Norcross. A splendid sort, uniform size and fine quality.

Rural Russet. A reliable late variety, practically blight-resistant. Quality excellent. A good keeper.

Spaulding Rose. A valuable late Potato of exceptional quality. Cooks white and mealy; does well in light soils.

Radish

One ounce will sow 100 feet of drill.

For very early use seeds can be sown in frames in February, making successive sowings every two or three weeks. Sow also in the open ground the last of April in light, rich, sandy soil, selecting a warm or sheltered location. Later sowings can be made at intervals during the summer in a moist location where they can grow quickly. Sow broadcast or in drills. Seeds of Winter Radishes should be sown during midsummer, and the Radishes can be kept during winter if covered with sand and placed in a cool cellar.

Early Crimson Giant. Grows to a large size without becoming plthy. Excellent for forcing. Pkt. 10c, oz. 25c, ¼ lb. 75c.

Earliest Forcing Deep Scarlet Turnip. Short leaved; very early; brilliant red; particularly fine for use in frames. Pkt. 10c, oz. 25c, ¼ lb. 75c.

Early Scarlet Globe. Of distinct shape, brilliant color, crisp and white; excellent for forcing. Pkt. 10c, oz. 25c, ¼ lb. 75c, lb. \$2.00.

Early Scarlet Turnip. Small, round Radish; very tender, mild and of quick growth. Pkt. 10c, oz. 15c, ¼ lb. 35c.

Early, Scarlet Turnip, White Tipped. A very early variety; color deep scarlet with white tip. Good forcer. Pkt. 10c, oz. 25c, ¼ lb. 75c.

French Breakfast. Scarlet, with white tip; shape nearly oval; good for forcing or summer sowing. Pkt. 10c, oz. 15c, ¼ lb. 35c.

Icicle. Quick growing; clear white. Fine for forcing. Pkt. 10c, oz. 25c, ¼ lb. 75c.

Long Black Spanish. One of the hardiest and best for winter use. Pkt. 10c, oz. 25c, ¼ lb. 75c.

Round Black Spanish. Skin black; roots globe-shaped; white fleshed and piquant flavor. Pkt. 10c, oz. 25c, ¼ lb. 75c.

Rose China Winter. Bright rose color, flesh firm and fine for winter use. Pkt. 10c, oz. 25c, ¼ lb. 75c.

White Turnip. Very early, flesh and skin white, of mild flavor; excellent for summer use. Pkt. 10c, oz. 25c, ¼ lb. 75c.

White Stuttgart. A quick growing variety of large size and of good quality. Pkt. 10c, oz. 25c.

Sweet Potato Plants

Culture—The young plants should be set in hills about 4 feet apart and 5 inches above the ground level. A light soil and sunny location are preferable. Rooted slips ready in May.

Nansemond. Best sort for New England. Plants, \$1.25 per 100, \$10.00 per 1000; add 15c per 100 if wanted by parcel post.

Pumpkin

One ounce will plant 20 hills. One pound 250 hills.

Sow in good soil in May, when the ground has become warm, in hills 8 to 10 feet apart each way; or in fields of Corn, about every fourth hill. The Pumpkin is not so particular in regard to soil as the Melon or Cucumber, but in other respects is cultivated in a similar manner. If planted in hills by themselves, thin out the plants when beginning to run, to three in each hill.

Connecticut Field. A large yellow variety, productive, and grown for feeding stock. Pkt. 10c, oz. 15c, ¼ lb. 50c, lb. \$1.50.

Mammoth. A productive variety, which grows to an immense size, often weighing more than a hundred pounds. Pkt. 10c, oz. 25c, ¼ lb. 75c, lb. \$2.50.

Sugar. A small, fine-grained, sweet Pumpkin; very prolific and a fine table variety. Pkt. 10c, oz. 15c, ¼ lb. 50c, lb. \$1.50.

Winter Luxury. Flesh thick, sweet and excellent for pies. Pkt. 10c, oz. 25c, ¼ lb. 75c.



Early Scarlet Globe Radish.

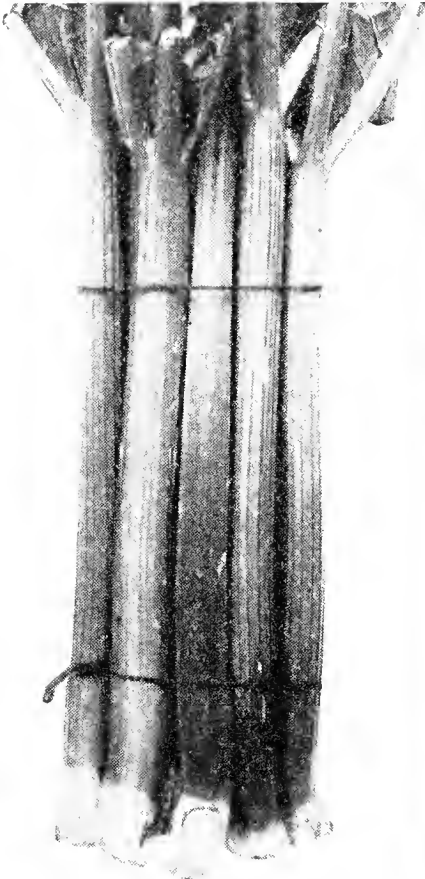

Linnaeus Rhubarb.

Mammoth Sandwich
Island Salsify.

Spinach

One oz. will sow 100 feet of drill; 12 lbs. will sow an acre.

Spinach may be grown on any ordinary soil. It is grown both as a spring and summer crop. For early use sow in August or September, in drills 12 to 14 inches apart. At the approach of cold weather cover lightly with straw, or any handy litter. Uncover when the plants begin to make a new growth in spring. For summer use sow early in spring in same way as above, using rather less seed.

Packets 10c, except where noted.

Bloomsdale or Savoy-leaved. A valuable variety with wrinkled leaves, resembling the Savoy Cabbage; it is very hardy and prolific. Oz. 15c, $\frac{1}{4}$ lb. 35c, lb. \$1.00.

King of Denmark. Especially desirable for sowing during April and May. Oz. 15c, $\frac{1}{4}$ lb. 35c, lb. \$1.00.

Mustard Spinach. (See page 53.) Pkt. 10c, oz. 25c, $\frac{1}{4}$ lb. 75c, lb. \$2.00.

New Zealand (Tetragonia expansa). May be started in a hotbed and transplanted or sown out-of-doors when the ground is warm, allowing two feet between the plants. Pkt. 10c, oz. 25c, $\frac{1}{4}$ lb. 75c, lb. \$2.00.

Nobel. Giant-leaved. By far the best of the so-called smooth-leaved varieties. Oz. 15c, $\frac{1}{4}$ lb. 35c, lb. \$1.00.

Perpetual or Spinach Beet. Produces green leaves in abundance close to the ground, and will give a constant supply through the season. Pkt. 10c, oz. 20c, $\frac{1}{4}$ lb. 50c.

Princess Juliana. The leaves are large; very dark green in color. A fine variety for the market. Oz. 15c, $\frac{1}{4}$ lb. 35c, lb. \$1.00.

Round Thick-Leaved. Leaves large, thick and fleshy; the variety generally grown for market and equally good for spring or fall sowing. Oz. 15c, $\frac{1}{4}$ lb. 35c, lb. \$1.00.

Savoy Blight-resisting. On account of its resistance to blight, the yield is often very large. A valuable variety to use for fall sowing. Oz. 15c, $\frac{1}{4}$ lb. 35c.

Savoy-leaved, Long-Standing. Darker green and more heavily crumpled than Bloomsdale, will stand ten days longer before bolting to seed. Oz. 15c, $\frac{1}{4}$ lb. 35c.

Rhubarb

One ounce will produce about 750 plants.

Rhubarb succeeds best in deep, rich loam. It is propagated by seed, or by division of the roots—the latter being the usual method. Sow the seeds in drills 18 inches apart, and thin out the plants to 9 inches apart in the drills. When the plants are one year old transplant into beds, setting the plants 5 feet apart each way. Do not cut until the second year and give a liberal dressing of manure every fall.

Linnaeus. The earliest and best for garden use; not as coarse and fibrous as the larger sorts. Pkt. 10c, oz. 50c, $\frac{1}{4}$ lb. \$1.50.

Victoria. The variety in general use for the market; yields immense crops. Pkt. 10c, oz. 50c, $\frac{1}{4}$ lb. \$1.50.

Roots. Either variety. Each 35c, doz. \$3.00.

Salsify or Vegetable Oyster

One ounce will sow 50 feet of drill.

Sow the seed early in spring, in drills 12 inches apart and 1 inch deep, thinning out the young plants to 6 inches. The roots will be ready for use in October, when a supply should be taken up and stored like Carrots. Those remaining will suffer no injury by being left in the ground till spring.

Long White French. Pkt. 10c, oz. 35c, $\frac{1}{4}$ lb. \$1.25.

Mammoth Sandwich Island. Tender and delicious; very superior. Pkt. 10c, oz. 30c, $\frac{1}{4}$ lb. \$1.00.

Scorzonera (Black Salsify). Cultivate the same as Salsify. The roots should not be scraped, but simply washed, boiled tender, then peeled and served like Asparagus. Pkt. 10c, oz. 50c, $\frac{1}{4}$ lb. \$1.50.

Sorrel

Broad-Leaved French. Used cooked as spinach or to mix with salads, sow seed in spring in good light soil in shallow drills one foot apart, thin out to four inches apart in the row; when the seed stalks appear, they should be cut out. Pkt. 10c, oz. 50c, $\frac{1}{4}$ lb. \$1.50, lb. \$4.00.

Round
Thick Leaved
Spinach.

All prices subject to change without notice.

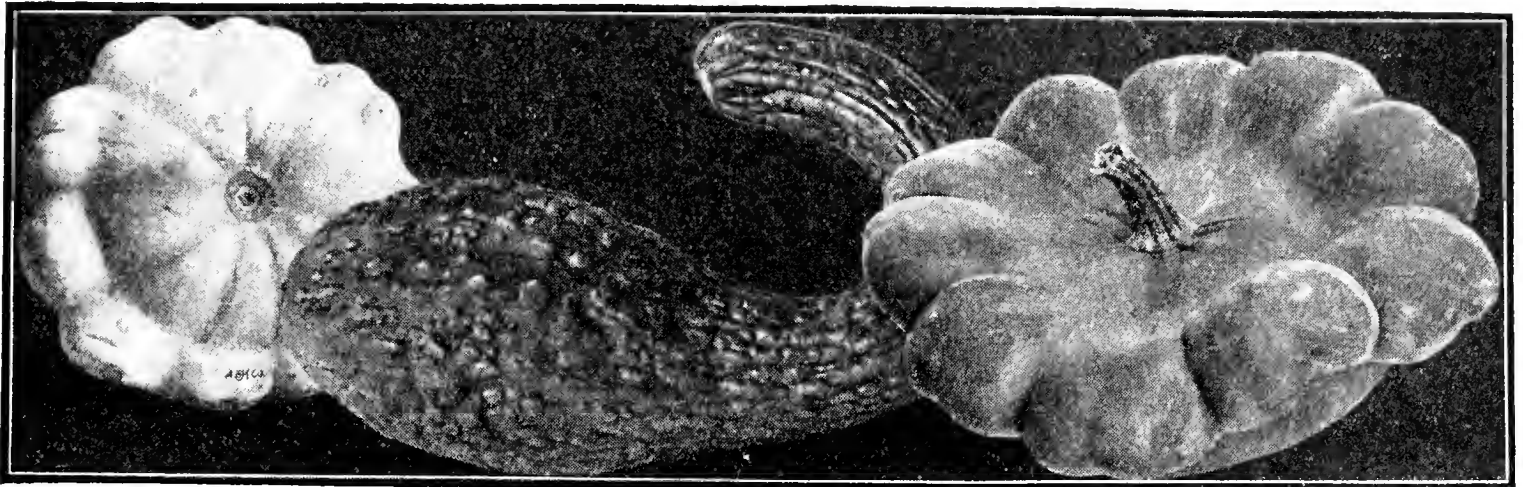

Early Mammoth White Scalloped.

Giant Summer Crookneck.

Early Yellow Scalloped.

Squash

One ounce of the small-seeded variety will plant 40 hills; of large-seeded, 15 hills.

Squashes, being very tender and sensitive to cold, should not be planted until the weather becomes warm and settled. Plant in well-manured hills, in the same manner as Cucumbers and Melons, the bush varieties 3 or 4 ft. apart each way, and the running kinds from 6 to 8 ft. apart. Sow 8 to 10 seeds to a hill, thinning out after they have attained their rough leaves, and danger from bugs is past, leaving two or three of the strongest plants in each hill.

Bay State. Blue, shell hard; flesh fine and dry, of sweet flavor; bright golden yellow color. Pkt. 10c, oz. 25c, ¼ lb. 75c.

Boston Marrow. A fall and winter variety of oval form, skin thin; when ripe, bright orange; an excellent keeper and of superior quality. Pkt. 10c, oz. 25c, ¼ lb. 75c.

Delicious. One of the best varieties for table use. It is a fall and winter Squash, excellent at all seasons. Pkt. 10c, oz. 25c, ¼ lb. 75c.

Des Moines. It is a small, dark green, acorn-shaped Squash, almost black in color, with deep ridges, hard shell, dry meat, small seed cavity, usually about 6 in. long and 4 in. in diameter. When fully matured it is an excellent keeper, therefore one of the best for home garden. Pkt. 10c, oz. 25c, ¼ lb. 75c.

Early Mammoth White Scalloped. One of the earliest summer Squashes; flat, scallop-shaped; light cream color. Pkt. 10c, oz. 25c, ¼ lb. 75c.

Early Prolific, or Orange Marrow. The earliest and most productive fall and winter Squash; color bright orange, flesh dry and sweet. Pkt. 10c, oz. 25c, ¼ lb. 75c.

Early Giant Summer Crookneck. Very early variety; long shape and of a bright yellow color. Pkt. 10c, oz. 25c, ¼ lb. 75c, lb. \$2.00.

Essex Hybrid Turban. Productive, with very hard shell; a solid, heavy, thick-fleshed sort of excellent flavor and keeps admirably. Pkt. 10c, oz. 25c, ¼ lb. 75c.

Giant Straightneck Summer. This is a new type, produced by one of New England's leading market gardeners. By careful selection he has produced a type nearly double the size of any other summer Squash. Despite its large size the flesh is rich and fine flavored. Its attractive appearance has made it popular with the market gardeners. We believe this new variety will eventually replace all other summer varieties. Pkt. 10c, oz. 25c, ¼ lb. 75c, lb. \$2.50.

Hubbard. Standard winter Squash; grown more extensively than any other late variety; color, dark green, shell extremely hard; flesh dry, fine grained and sweet; excellent keeper. Pkt. 10c, oz. 25c, ¼ lb. 75c, lb. \$2.50.

Hubbard Mammoth Wartyed. A superior strain of mammoth size and entirely covered with warty excrescences. Rich, dark green color and of very best quality. Pkt. 10c, oz. 25c, ¼ lb. 75c, lb. \$2.50.

Hubbard, Golden. Earlier than Hubbard; color a rich orange-red; hard and warty. Pkt. 10c, oz. 25c, ¼ lb. 75c, lb. \$2.50.

Hubbard, Symmes Blue. A superior strain, thick meated, fine grained, dry and very sweet. A heavy cropper and good keeper. Pkt. 10c, oz. 35c, ¼ lb. \$1.00.

The Warren. Resembles the Essex Hybrid but has a shell generally harder and thicker. The color is of a richer and deeper orange. The flesh is of excellent quality. Pkt. 10c, oz. 35c, ¼ lb. \$1.00.

Vegetable Marrow, English. Grows about 9 inches long. Pale straw colored, changing to a deeper shade. Flesh white. Pkt. 10c, oz. 25c, ¼ lb. 75c.

Vegetable Marrow, Italian (Cocozelle di Napoli). Skin smooth, mottled, dark and light green. Grows from 12 to 20 inches long. Flesh delicate green; quality fine. Pkt. 10c, oz. 25c, ¼ lb. 75c.

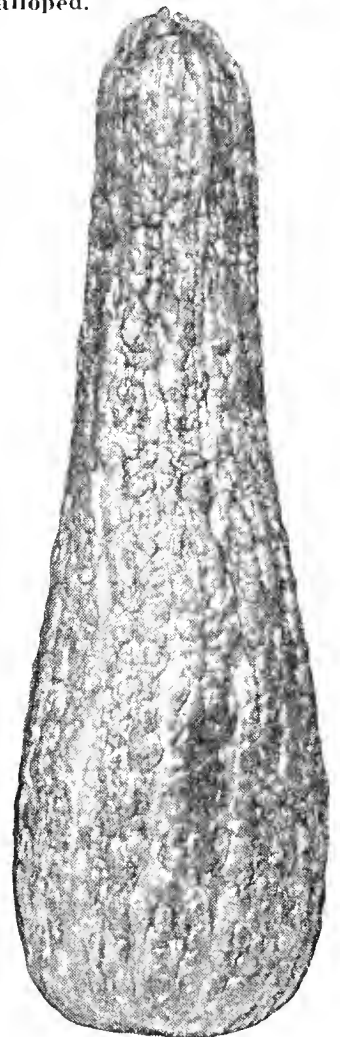

Giant Summer Straightneck.

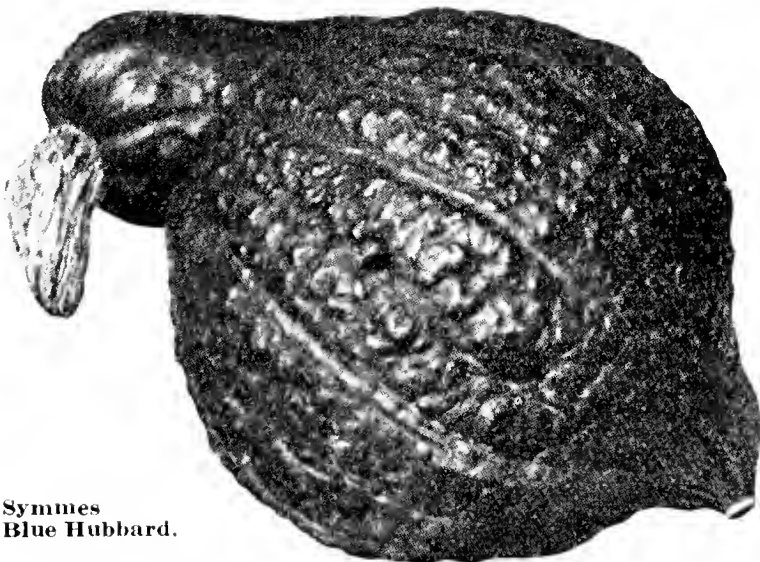

Symmes Blue Hubbard.

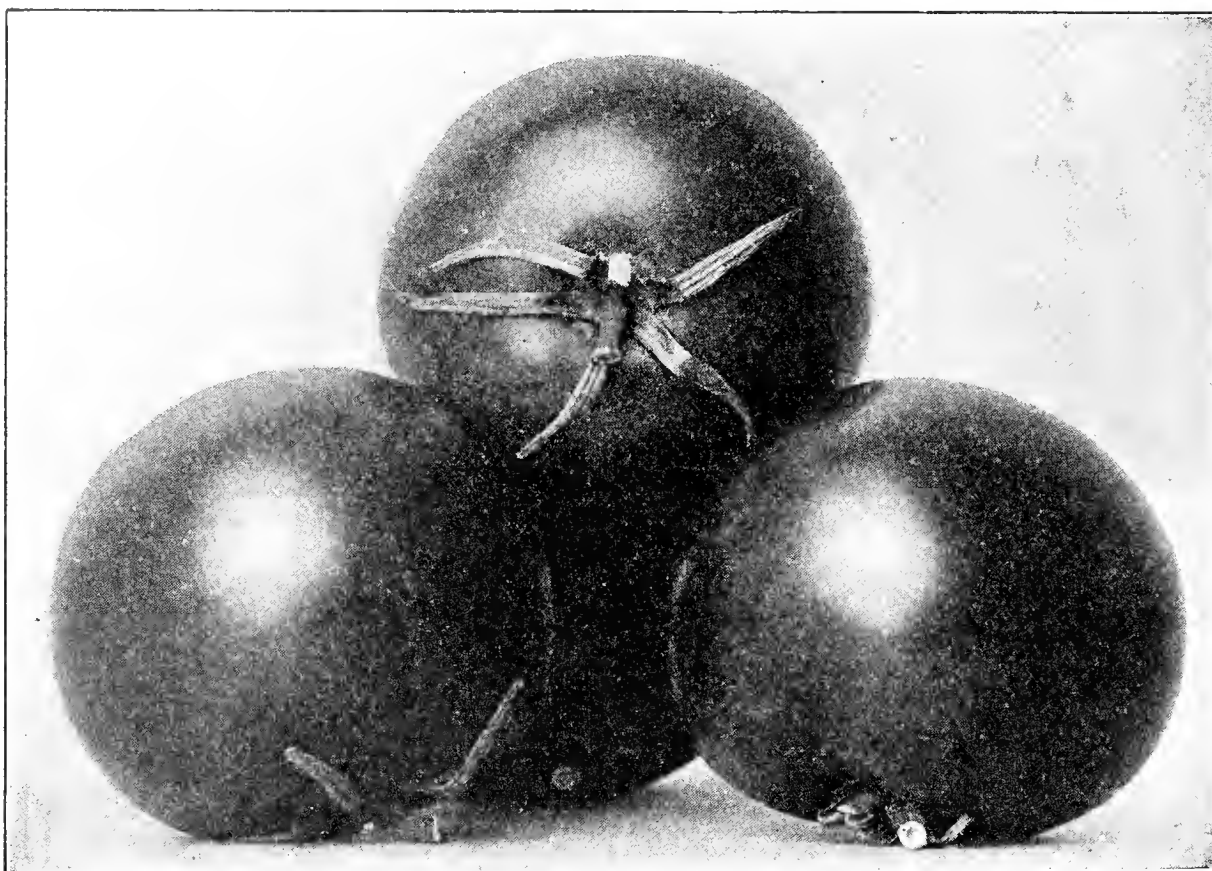

Tomato, Lister's Prolific.

Tomato

One ounce will produce 1500 plants.

Seed should be grown in a hotbed the first week in March, in drills 5 inches apart. When the plants are about 2 inches high they should be set out 4 or 5 inches apart in another hotbed, or removed into small pots, allowing a single plant to a pot. About the middle of May the plants may be set out in the open ground; they are planted for early crops on light, sandy soil, at a distance of 3 feet

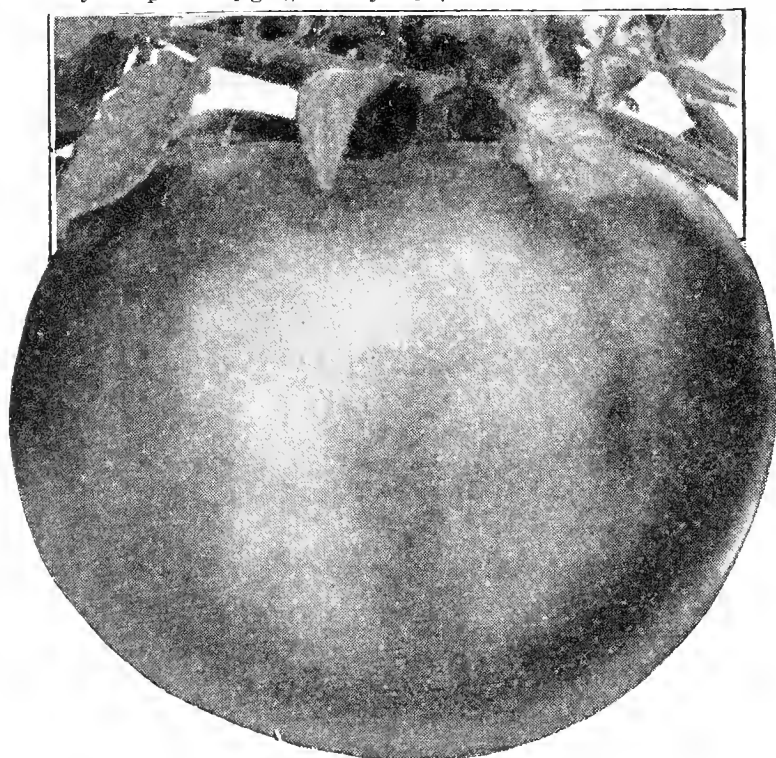

John Baer Tomato.

apart, in hills in which a good shovelful of rotted manure should be mixed. On heavy soil, which is not suited for an early crop, they should be planted 4 feet apart. Water freely at the time of transplanting, and shelter from the sun for a few days until the plants are established.

Ailsa Craig. One of the best forcing varieties, also does well outdoors; a heavy cropper. Fruit medium size, smooth and of a rich scarlet color. Pkt. 25c.

Belmont, Improved. An excellent scarlet variety. Early, Medium, size; solid and smooth. Pkt. 10c, oz. 40c, ¼ lb. \$1.25.

Best of All, Sutton's. A good forcing or outdoor variety; deep scarlet; solid. Pkt. 25c, oz. \$1.00.

Bonny Best. Early, productive. Smooth, solid and uniform in size; scarlet. Pkt. 10c, oz. 40c, ¼ lb. \$1.25.

Break o' Day. An early Tomato of the Marglobe type, fruit of good size, color scarlet; smooth and of good quality. Pkt. 10c, oz. 50c, ¼ lb. \$1.75.

Carter's Sunrise (True Stock). One of the best Tomatoes for indoor or outdoor cultivation. Perfect in shape, of good size and free cropper; the fruit is bright red. Pkt. 25c, oz. \$1.00.

Chalk's Early Jewel. Large, solid, smooth, bright red variety. Pkt. 10c, oz. 40c, ¼ lb. \$1.25.

Comet. One of the best for forcing; brilliant scarlet color, medium size, smooth and solid. Pkt. 10c, oz. 75c, ¼ lb. \$2.25.

Dwarf Champion. Of compact, upright growth. Fruit solid, smooth, purplish red. Pkt. 10c, oz. 40c, ¼ lb. \$1.25.

Dwarf Stone. Resembles Dwarf Champion; fruit larger and more prolific; fine color. Pkt. 10c, oz. 40c, ¼ lb. \$1.25.

Earliana. The earliest red Tomato. Very smooth; fine for market. Pkt. 10c, oz. 40c, ¼ lb. \$1.25.

Golden Ponderosa. A large golden yellow variety of excellent quality. Pkt. 10c, oz. 50c, ¼ lb. \$1.50.

Golden Queen. The best yellow variety, medium size, smooth and solid. Pkt. 10c, oz. 50c, ¼ lb. \$1.50.

Globe, Livingston's. Very early; large, smooth variety. Pkt. 10c, oz. 40c, ¼ lb. \$1.25.

Tomatoes—Continued

- John Baer.** An early bright scarlet new Tomato. Large and fleshy. Pkt. 10c, oz. 40c, ¼ lb. \$1.25.
- Lister's Excelsior.** One of the best for forcing or outdoor culture; a heavy cropper of good flavor and color. Original pkt. 50c.
- Lister's Prolific.** This variety planted out or grown in a greenhouse has proved a remarkably valuable variety. Pkt. 50c.
- Lister's Protection.** The best of Lister's productions. Color dark crimson, a heavy cropper, perfect in shape and size. Pkt. 75c.
- Marglobe.** A midseason variety entirely immune from rust, pure scarlet, globe-shaped. Good size, heavy cropper and fine quality. Pkt. 10c, oz. 40c.

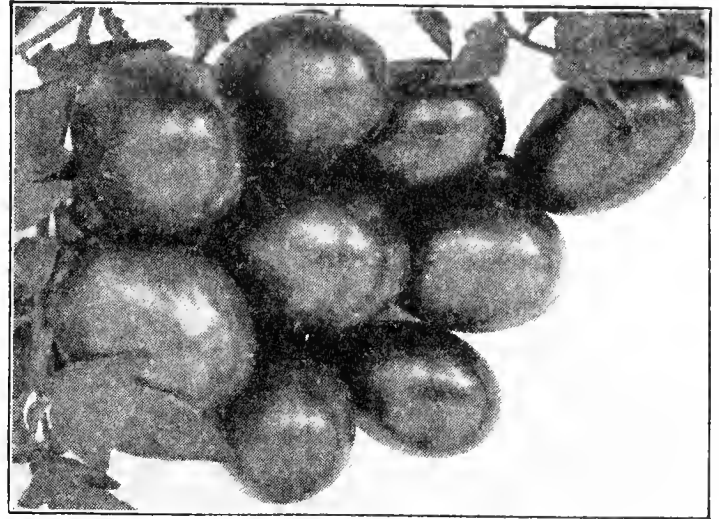

Plum Shaped Yellow Tomato.

SMALL FRUITED VARIETIES

- Red Cherry.** Valuable for preserving. Pkt. 10c, oz. 50c, ¼ lb. \$1.50.
- Red Currant.** Very small. Used in preserves. Pkt. 10c, oz. 50c, ¼ lb. \$1.50.
- Red Peach.** A small pink-fruited variety. Pkt. 10c, oz. 50c, ¼ lb. \$1.50.
- Red Pear.** Solid, handsome fruit. Good preserving variety. Pkt. 10c, oz. 50c, ¼ lb. \$1.50.
- Red Plum.** Valuable for salads. Pkt. 10c, oz. 50c, ¼ lb. \$1.50.
- Strawberry Tomato or Winter Cherry.** Fruit grows in a husk and will keep all winter. Pkt. 10c, oz. 50c, ¼ lb. \$1.50.
- Yellow Cherry.** Same as Red Cherry except for color. Pkt. 10c, oz. 50c, ¼ lb. \$1.50.
- Yellow Peach.** Fruits have a beautiful Peach appearance. Pkt. 10c, oz. 50c, ¼ lb. \$1.50.
- Yellow Pear.** Fruits set in large cluster. Pkt. 10c, oz. 50c, ¼ lb. \$1.50.
- Yellow Plum.** Valuable for salads and pickling. Pkt. 10c, oz. 50c, ¼ lb. \$1.50.

- Ponderosa.** Very large, solid and of excellent flavor. Pkt. 10c, oz. 40c, ¼ lb. \$1.25.
- Scott's Ellenbank.** A very large cropper, carrying trusses from 3 to 4 lbs. One of the best Tomatoes for indoor or outdoor cultivation. Pkt. 75c.
- Stirling Castle.** This is one of the best for indoor culture. Round, smooth, delicious flavor. Pkt. 25c, ¼ oz. \$1.00, oz. \$3.00.
- Stone, Livingston's.** Large, bright scarlet, solid, smooth, later than many, very productive. Pkt. 10c, oz. 40c, ¼ lb. \$1.25.

Turnip

One ounce will sow 150 feet of drill; 1½ lbs. per acre.

Turnips do best in highly enriched, light, sandy or gravelly soil; sow the earliest varieties as soon as the ground can be worked in the spring, in drills 12 to 18 inches apart. Seed can also be sown broadcast, using 3 pounds to the acre. For a continuous supply through the season, sowings should be made every two weeks until the last of July, from which time until the middle of August the principal sowings are made for fall and winter use. Swedish or Rutabaga Turnips are largely grown for a farm crop, as well as for the table; make sowings from the 10th of June until the last of July, in drills 2 to 3 feet apart, and the plants when well up should be thinned to from 8 to 10 inches apart. They are best preserved in a pit or cellar during the winter and are excellent for the table early in spring.



Purple Top Strap Leaf Turnip.

- Extra Early Milan, White.** A beautiful early variety with small tops, tender and sweet. Pkt. 10c, oz. 20c, ¼ lb. 50c.
- Golden Ball.** Bulb of fine form and bright yellow color, a fine keeper; unsurpassed for table use. Pkt. 10c, oz. 20c, ¼ lb. 60c, lb. \$1.50.
- Milan Early, Purple Top.** The earliest of the white flesh varieties. Pkt. 10c, oz. 25c, ¼ lb. 75c.
- Purple Top Strap Leaf.** A well known variety, extensively grown both for table and for stock. Pkt. 10c, oz. 15c, ¼ lb. 30c, lb. 90c.
- Purple Top White Globe.** A handsome, globe shaped variety, valuable for market purposes. Pkt. 10c, oz. 20c, ¼ lb. 50c, lb. \$1.25.
- White Egg.** Oval shaped variety for spring or fall sowing; flesh white, firm, fine-grained, mild and sweet. Pkt. 10c, oz. 20c, ¼ lb. 50c, lb. \$1.25.
- Yellow Aberdeen.** Hardy, productive and a good keeper; yellow, flesh firm, good for table use or feeding stock. Pkt. 10c, oz. 20c, ¼ lb. 60c, lb. \$1.50.

Rutabaga or Swedish Turnip

- Budlong Swede.** A choice strain of the white Rutabaga, earlier than others, and more nearly round in form. Sweet, of excellent flavor and keeps well. Pkt. 10c, oz. 15c, ¼ lb. 40c, lb. \$1.00.
- Carter's Imperial.** An excellent sort, for either table use or feeding stock. Flesh yellow, solid, firm, sweet and rich. Pkt. 10c, oz. 25c, ¼ lb. 75c, lb. \$2.00.
- Improved American, Purple Top.** A yellow-fleshed, purple top variety grown for stock or table. Pkt. 10c, oz. 15c, ¼ lb. 40c, lb. \$1.00.
- Monarch.** A deep yellow fleshed, purple top variety, smooth, oval form, slightly tapering at ends; small neck and fine for table use. Pkt. 10c, oz. 15c, ¼ lb. 40c, lb. \$1.00.
- Snowball.** A very early, pure white variety of medium size. Pkt. 10c, oz. 20c, ¼ lb. 60c, lb. \$1.50.
- Shamrock.** An excellent variety; grows with small top and very few leaves; a good keeper; desirable either for stock or table use. Pkt. 10c, oz. 15c, ¼ lb. 40c, lb. \$1.00.
- White French.** Oval in form, clear white flesh; one of the best winter Turnips. Pkt. 10c, oz. 15c, ¼ lb. 40c, lb. \$1.00.

Pot, Sweet and Medicinal Herbs

Plant in the spring when the ground is warm, in drills, covering lightly. When the plants are well up, thin out or transplant to about 4 inches apart. They should be harvested on a day just before the blossom develops, dried quickly and bottled, or closely packed in dry boxes with the air entirely excluded.

- Anise** (*Pimpinella anisum*). Annual. Used for flavoring and garnishing. Pkt. 10c, oz. 30c.
- Arnica** (*Arnica montana*). Perennial. Used in medicine as a narcotic and stimulant. Pkt. 10c, oz. \$2.00.
- Balm** (*Melissa officinalis*). Perennial. Leaves have a fragrant odor and are used medicinally. Pkt. 10c, oz. \$1.00.
- Basil, Sweet** (*Ocimum basilicum*). Annual. Used for flavoring soups, stews, etc. Pkt. 10c, oz. 30c.
- Borage** (*Borago officinalis*). Annual. Leaves are used for flavoring and bees are attracted by the flowers. Pkt. 10c, oz. 40c.
- Caraway** (*Carum carui*). Perennial. Used for flavoring confectionery, bread, etc. Pkt. 10c, oz. 30c.
- Catnip** (*Nepeta cataria*). Perennial. Sometimes used in medicine. Pkt. 10c.
- Coriander** (*Coriandrum sativum*). Annual. Used in the manufacture of confectionery and liquors. Pkt. 10c, oz. 30c.
- Dill** (*Anethum graveolens*). Biennial. The seeds are aromatic and pungent. Used in pickling cucumbers. Pkt. 10c, oz. 50c.
- Fennel, Sweet** (*Antheum foeniculum*). Perennial. Leaves when boiled are used in sauces. Pkt. 10c, oz. 50c.
- Fennel, Florence** (*Anethum foeniculum*). The roots are boiled, also used as salad. Pkt. 10c, oz. 50c.
- Horehound** (*Marrubium vulgare*). Perennial. Used medicinally, also for seasoning. Pkt. 10c, oz. 50c.

- Hyssop** (*Hyssopus officinalis*). Perennial. Used medicinally. The leaves have a pungent taste. Pkt. 10c, oz. 60c.
- Lavender** (*Lavandula vera*). Perennial. Yields an oil used in medicine and perfumery. Pkt. 10c, oz. \$1.00.
- Lovage** (*Levisticum officinale*). Perennial. An aromatic stimulant used in medicine. Pkt. 10c, oz. \$1.00.
- Marjoram, Sweet** (*Origanum majorana*). Annual. Aromatic and fragrant. Much used in flavoring. Pkt. 10c, oz. 80c.
- Pennyroyal** (*Hedeoma pulegioides*). Annual. An aromatic medicinal herb. Pkt. 10c, oz. \$1.00.
- Rosemary** (*Rosmarinus officinalis*). Perennial. Leaves fragrant, with warm, pungent, bitterish taste. Pkt. 10c.
- Rue** (*Ruta graveolens*). Perennial. Has a strong, heavy odor and bitter taste. Used medicinally. Pkt. 10c, oz. \$1.25.
- Saffron** (*Carthamus tinctorius*). Annual. Flowers are used as a dyestuff and in making rouge. Pkt. 10c.
- Sage** (*Salvia officinalis*). Perennial. More used than any other herb for dressings and seasoning. Pkt. 10c, oz. 50c.
- Sorrel** (*Rumex crispus*). Perennial. Used for salads or cooked and served as Spinach. Pkt. 10c, oz. 50c.
- Summer Savory** (*Satureia hortensis*). Annual. Used for flavoring soups and dressings. Pkt. 10c, oz. 25c.
- Thyme** (*Thymus vulgaris*). Perennial. Used for seasoning. Also used medicinally. Pkt. 10c, oz. \$1.25.
- Wormwood** (*Artemisia absinthium*). Perennial. Used medicinally and is beneficial for poultry. Pkt. 10c.

PLANTS OF HERBS—To meet the increasing demand for plants of the most popular herbs, we can supply 3 plants for \$1.25, 10 for \$3.50. Not less than 3 of one variety sold.

Vegetable Roots and Plants

We do not send Vegetable Plants by mail except where noted.

ASPARAGUS, Selected Roots.	100	1000
Martha Washington	\$2.00	\$18.00
Mary Washington	2.25	20.00
ARTICHOKE, Jerusalem. Qt. 40c, by mail 10c additional; pk. \$2.50.		
ARTICHOKE PLANTS, Green Globe. May delivery. Doz. \$2.50.		
	Doz.	100
BRUSSELS SPROUTS PLANTS	\$0.30	\$1.50
CABBAGE PLANTS:		
Early Jersey Wakefield30	1.50
Globe Curled Savoy30	1.50
Henderson's Summer30	1.50
Stone Mason30	1.50
CAULIFLOWER PLANTS:		
Earliest Erfurt30	2.00
Early Snowball30	2.00
CELERY PLANTS.		
Boston Market25	1.25
Golden Self Blanching25	1.25
Giant Pascal25	1.25

CHIVES, Roots. 30c per clump, 12 clumps, \$3.00. By mail, add 10c extra for each clump.		
EGGPLANT	Doz.	100
Black Pekin	\$1.00	\$7.00
New York Improved	1.00	7.00
HORSERADISH. Sets or cuttings35	1.75
LETTUCE PLANTS25	1.25
MINT ROOTS	25c each..	2.50 18.00
PEPPER PLANTS50	3.00
RHUBARB ROOTS.	Each	Doz.
Victoria. Largest variety35	3.00
Clumps75	
TARRAGON PLANTS (Estragon).50	5.00
TOMATO PLANTS (Pot-grown)	Doz.	100
Bonny Best	\$1.00	\$7.00
Dwarf Champion	1.00	7.00
Dwarf Stone	1.00	7.00
John Baer	1.00	7.00
Stone, Livingston's	1.00	7.00

Tobacco

- Connecticut Seed-leaf. Suited to the climate of the Northern and Middle States. Pkt. 10c, oz. 75c.
- Havana, Imported Seed. Pkt. 10c, oz. 75c.

Free Delivery

IN GREATER BOSTON we deliver, Free of Charge, all merchandise purchased at retail catalog prices at our option.

Special Notice

We do not send Vegetable Plants, such as Cabbage, Cauliflower, Eggplant, Parsley, Pepper and Tomato Plants, via Parcel Post. The foliage of these plants is very soft and tender and (largely) because of delays in the mail they reach their destination in a worthless condition. We do not ship plants or other perishable goods C. O. D. Customer pays express or freight charges on Roots and Plants.

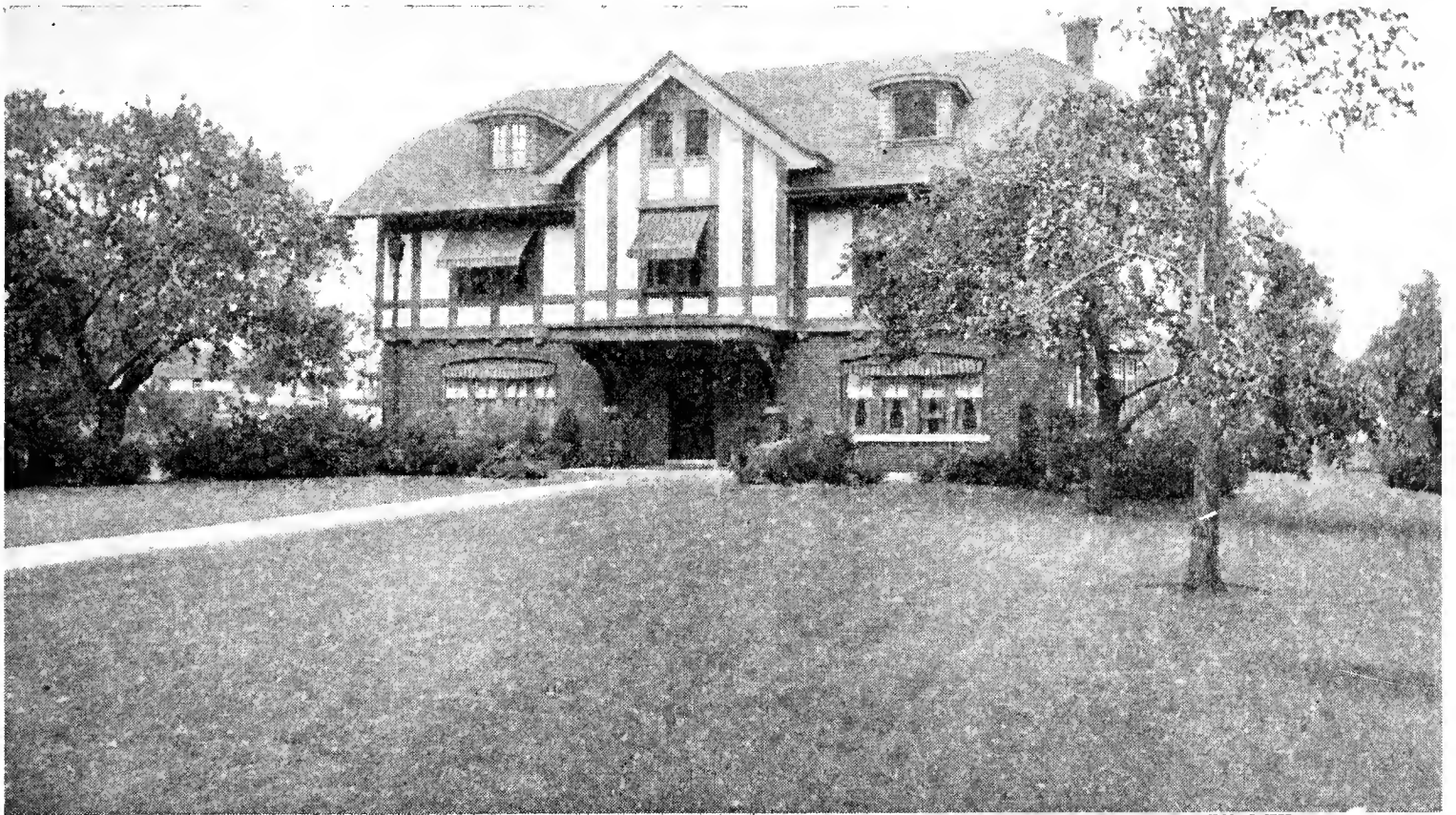

Grey's Special Lawn Grass Seed Mixtures

The following directions may be useful to those who are not familiar with lawn making.

The soil should be of good depth, moderately rich, the land should be carefully drained, and the soil thoroughly pulverized. Some good fertilizer—pure ground bone, wood ashes, or a specially prepared lawn fertilizer—should be used. After sowing, the ground should be lightly raked and rolled.

The selection of seed is important. Use only such mixtures as are free from weed seeds, and such as will produce a firm, strong turf and a fine growth. A liberal quantity is necessary to secure good results (not less than 64 pounds per acre). The best time to make a lawn is from the middle of August through September. If seed is sown at this season, the grass will become strong enough to withstand the winter, and a good lawn is assured the following season.

Grey's Special Recleaned Lawn Grass Seed

In recommending this grade to our customers we are recommending a mixture which cannot be excelled for general lawn purposes. Weight 32 lbs. per bu. Sow 64 lbs. per acre. Per lb. 55c, per 100 lbs. \$45.00.

GREY'S SPECIAL BENT GRASS MIXTURE. A combination of Bent grasses and red top which will produce a turf much finer in texture than a lawn of the ordinary type. Per lb. \$1.50, per 100 lbs. \$125.00.

GREY'S GRASS MIXTURE FOR SHADED LAWNS. Fine grasses selected especially for locations partially shaded by buildings or trees. Weight 24 lbs. per bu. Per lb. 65c, per 100 lbs. \$50.00.

GREY'S BANK AND TERRACE GRASS MIXTURE. This mixture is composed of deep rooting varieties which will give satisfactory results on steep inclines or terraces. Per lb. 55c, per 100 lbs. \$45.00.

GREY'S NO. 2 LAWN GRASS MIXTURE. To meet the requirements of those desiring a moderate-priced lawn seed, and suitable for various soils. This mixture is composed of such varieties as to produce a permanent, heavy turf. Weight 20 lbs. per bu. Per lb. 45c, per 100 lbs. \$35.00.

Our aim is purity, quality and service. We are headquarters for the finest lawn grasses, agricultural grasses, fertilizers, spraying material, International Harvester Company's line of implements, plows, etc.

Special Mixtures for Tennis Courts, Golf Links, etc.

The following mixtures used on many prominent golf courses, etc., in this vicinity, have given entire satisfaction.

Fair Green Mixture. For general use on golf links. Per lb. 50c, 100 lbs. \$40.00.

Putting Green Mixture. A combination of grasses best suited to produce a close, firm and lasting turf which will endure frequent cutting. Per lb. 60c, 100 lbs. \$50.00.

Tennis Court Mixture. A mixture of fine grasses especially adapted to tennis courts, which will bear trampling without injury. Per lb. 55c, 100 lbs. \$45.00.

Ball Grounds Mixture. This mixture is used by both the Leagues in Boston with the most satisfactory results. Per lb. 45c, 100 lbs. \$35.00.

Bowling Green Mixture. Mixture of fine, hardy grasses, especially adapted for bowling greens. Lb. 60c, 100 lbs. \$50.00.

Seashore Lawn Grass Mixture. A mixture of fine grasses selected for their deep rooting qualities. Per lb. 55c, 100 lbs. \$45.00.

PRICES SUBJECT TO CHANGE WITHOUT NOTICE.

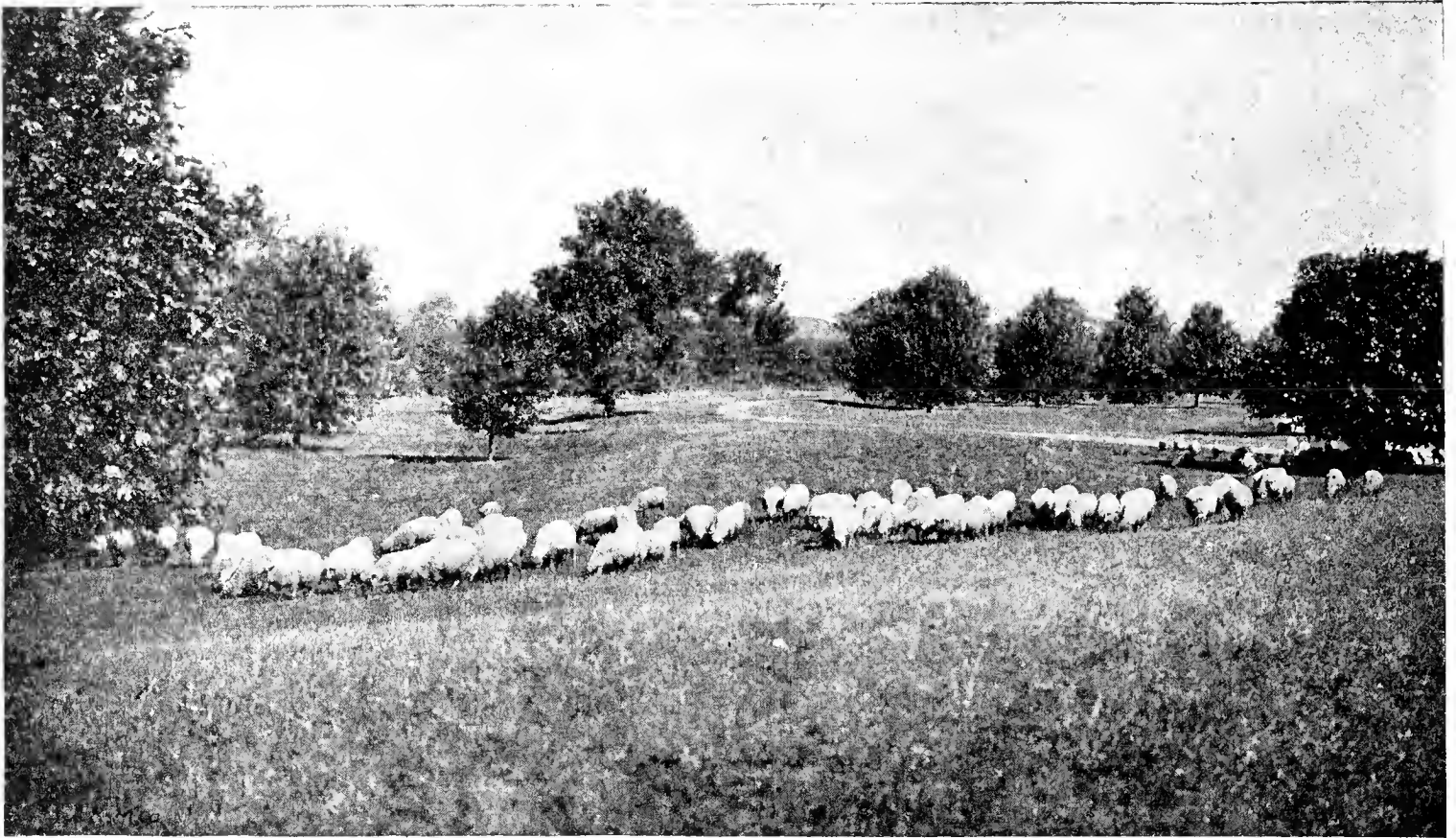

Choice Grass Seeds

All strictly Recleaned and Carefully Tested for Purity and Germination.

All grasses sold f.o.b. Boston. Bags extra. Prices subject to market changes. Samples sent on request. Many growers of grass seeds offer several grades of each variety, varying greatly in price. We do not recommend nor do we sell the inferior grades. Those which we offer are strictly **high grade**, and the prices at which we offer them should not be compared with those quoted for inferior grades.

Free Delivery. We will prepay Parcel Post charges on cash orders at quoted catalogue prices on Grass Seeds, up to two pounds, anywhere in the United States, east of the Mississippi River; for larger quantities, the purchaser pays transportation charges.

Chewing's New Zealand Fescue. A splendid grass of creeping habit, forming a close and lasting turf. An excellent grass for golf courses. Lb. 90c, 100 lbs. \$85.00.

Crested Dogstail (*Cynosurus cristatus*). Good for permanent pasture; is productive and early. 35 lbs. to the acre. Lb. 55c, 100 lbs. \$50.00.

Fine-Leaved Fescue (*Festuca tenuifolia*). Its dwarf habit and fineness of leaf render it suitable for dry slopes on lawn. Weight 22 lbs. per bu. Lb. \$1.00, 100 lbs. \$90.00.

Italian Rye Grass (*Lolium italicum*). Valuable for mixing with other pasture grasses; sow 50 lbs. to the acre. Lb. 20c, 100 lbs. \$18.00.

Kentucky Blue (*Poa pratensis*). For pastures and lawns it has no superior, giving that peculiar rich shade of bluish green so much admired in the best lawns; also making a very close, velvety turf. It is usually sown mixed with other fine grasses; when used alone, 30 to 40 lbs. per acre. Fancy clean seed. Lb. 25c, 100 lbs. \$20.00.

Meadow Fescue (*Festuca pratensis*). One of the best grasses for permanent pasture on a great variety of soils; sow 40 lbs. per acre. Lb. 25c, 100 lbs. \$20.00.

Meadow Foxtail (*Alopecurus pratensis*). One of the best and earliest of pasture grasses. 30 lbs. to the acre. Lb. 60c, 100 lbs. \$55.00.

Orchard (*Dactylis glomerata*). One of the earliest grasses; yields immense crop and is excellent for pasture or hay. Sow 40 lbs. per acre. Lb. 25c, 100 lbs. \$20.00.

Perennial Rye Grass (*Lolium perenne*). A valuable grass for pastures or meadows; also very valuable where mixed with other grasses for lawns, golf links, etc. We offer an extra choice lot of seed. Lb. 25c, 100 lbs. \$20.00.

Red Top (*Agrostis vulgaris*). Invaluable for lawn seed mixture.

Unhulled Seed. 10 lbs. per bu. Lb. 15c, 100 lbs. \$10.00.

Fancy Recleaned Seed. Absolutely clean and free from chaff. 36 lbs. per bu. Lb. 20c, 100 lbs. \$16.00.

Red, or Creeping Fescue (*Festuca rubra*). A creeping rooted grass forming a close and lasting turf. Lb. \$1.00, 100 lbs. \$90.00.

Rough Stalked Meadow Grass (*Poa trivialis*). Especially adapted to the shaded parts of lawns. It thrives on moist rich soils and in sheltered situations. Lb. 45c, 100 lbs. \$40.00.

Sheep's Fescue (*Festuca ovina*). This is especially valuable as it thrives on poor, light or gravelly soils. 16 lbs. per bu. Lb. 85c, 100 lbs. \$80.00.

Sweet Vernal, True Perennial (*Anthoxanthum odoratum*). Useful to mix with other grasses; it is invaluable on account of its early growth and the fragrant odor which it imparts when drying. Lb. \$1.50.

Tall Fescue (*Festuca elatior*). Succeeds best on moist, alluvial and strong, clayey soils. Lb. 45c.

Tall Meadow Oat Grass (*Avena elatior*). This grass produces an abundant supply of foliage, and is valuable for pasture. Lb. \$1.50.

Timothy, "Herd's Grass" (*Phleum pratense*). It is generally sown with Red Top and Red Clover, and makes the most valuable hay. 45 lbs. per bu. Present price, lb. 15c, 100 lbs. \$10.00.

Wood Meadow (*Poa nemoralis*). A variety specially suited for the shaded portions of lawns, where other grasses do not grow. The creeping roots make a strong, firm sod. Lb. \$1.50, 100 lbs. \$125.00.

All prices subject to change without notice.

Bent Grasses for Lawns and Putting Greens

The various Bent Grasses have come into wide use for lawns and putting greens as they thrive in nearly all soils and produce a low, velvety sward of handsome, velvety texture.

- Colonial Bent.** A fine, hardy, very compact grass; very permanent, readily forming a heavy sward. Per lb. \$1.50.
- Creeping Bent** (*Agrostis stolonifera*). One of the most valuable lawn grasses because of its short growth and deep green, fine-leaved foliage. Its stoloniferous roots form a strong, close, enduring turf, which is not injured by being frequently walked on. Per lb. \$1.50.
- German Mixed Bent** (*European agrostis*). Makes beautiful thick velvety putting greens and lawns. Per lb. \$1.50.
- Rhode Island Bent.** Resembles Red Top but is of dwarfer habit. A fine, hardy, very compact grass; excellent for lawns. Sow 4 bus. per acre if alone. 14 lbs. per bu. Per lb. \$1.50.
- Seaside Bent or Cocoos Bent** (*Agrostis stolonifera compacta; agrostis maritima*). A creeping variety valuable for lawns and putting greens, producing a velvety turf of beautiful texture. Per lb. \$1.50.
- Velvet Bent** (*Agrostis canina*). A variety which is ideal for the finest lawns. This is the dwarfest of the turf grasses. Per lb. \$6.00.

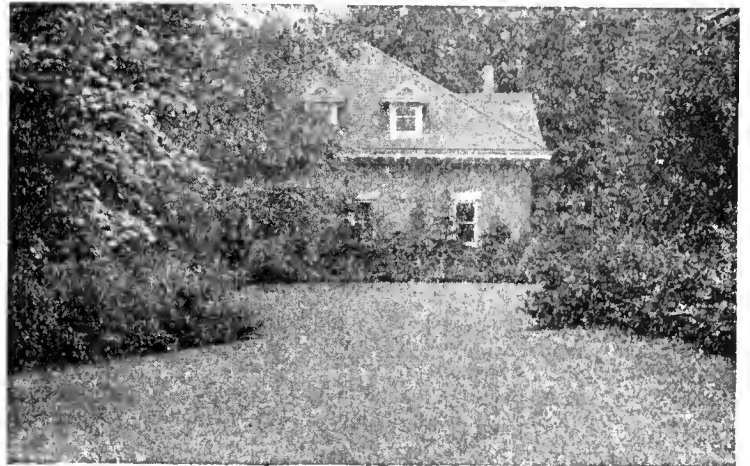

Special Mixtures

For Permanent Hay

Sow 50 pounds to acre.

No. 1 for Cool, Moist Soils	100 lbs.	\$25.00
No. 2 for High Dry Soils		25.00
No. 3 for Wet Soils		25.00

For Permanent Pastures

Sow 50 pounds to an acre.

No. 4 for Cool Moist Soils	100 lbs.	\$30.00
No. 5 for High, Dry Soils		30.00
No. 6 for Wet Soils		30.00

Clover Seeds



Alfalfa.

Before Planting Clover Inoculate Seed with



Prices subject to change with the market.

- Alfalfa, Genuine Grimm.** It originated in northern Minnesota. The strong branching roots of Genuine Grimm Alfalfa prevent winter-killing. Sow 15 to 20 lbs. per acre. Lb. 35c, 100 lbs. \$30.00.
- Alsike, or Swedish** (*Trifolium hybridum*). Hardest of all the Clovers, and on rich, moist soil yields an enormous quantity of hay or pasturage. Valuable for sowing with Clovers or grasses, as it forms a thick bottom and increases yield of hay. Lb. 35c, 100 lbs. \$30.00.
- Bokhara Clover** (*Melilotus alba*). Valuable sort for soiling and for ensilage and bees. Grows from 3 to 5 feet high; sown in rich soil, may be cut three times; lasts for years if cut before flowering. 15 lbs. to the acre. Lb. 15c, 100 lbs. \$12.00.
- Crimson Clover** (*Trifolium incarnatum*). Sow in April or May; 20 lbs. to the acre. Not always hardy in New England. Lb. 20c, 100 lbs. \$18.00.
- Red Clover, Medium** (*Trifolium pratense*). The leading variety of Clover for pastures or meadows. Requires deep rich soil. Sow in spring. Lb. 30c, 100 lbs. \$25.00.
- Red Clover, Mammoth.** Grows 4 to 5 ft. high, and is used to plow under for manure. Lb. 30c, 100 lbs. \$25.00.
- White Dutch Clover** (*Trifolium repens*). The best variety for lawns, as it forms a close herbage and remains green throughout the season; valuable when mixed with grass seeds for pasture. Lb. 45c, 100 lbs. \$40.00.

BIRD SEEDS

(Prices subject to market fluctuations)

	Lb.	100 lbs.
Blue Maw, or Poppy	\$0.35	\$30.00
Canary Seed, Choice Recleaned15	12.00
Hemp Seed, Recleaned Russian15	10.00
Rape, Bird15	10.00
Rape, English15	10.00
Mixed Bird Seed. In bulk15	10.00
Lettuce for Birds30	20.00
Rice, Unhulled, or Paddy20	15.00

	Lb.	100 lbs.
Millet, Golden	\$0.10	\$ 8.00
Millet, White French20	18.00
Wild Bird Food Mixture10	8.00
Niger Seed40	35.00
Cuttle Fish Bone50	45.00
Sunflower Seed20	15.00
Kaffir Corn10	5.00
Vetch for Pigeons10	6.00
Peas, Small white10	7.00

All prices subject to change without notice.

Farm and Field Seeds

All prices subject to market changes.

Barley

48 lbs. to the bushel; 2 bushels to the acre.

	Peck	Bushel
Four or six-rowed	\$.75	\$2.25
Two-rowed75	2.25

Beans

Sow 1 bushel to the acre.

Yellow Soja. A large-growing, yellow-seeded variety, especially suitable for ensilage and plowing under. Pk. \$1.25, bu. \$4.00.

Ito San. An early, small-leaved variety recommended for latitudes having short season, especially New England. Pk. \$1.25, bu. \$4.00.

Wilson. A rank-growing variety, branching high, leaves large, both pods and leaves remaining on vines long after cutting. Pk. \$1.25, bu. \$4.00.

Beets, Mangel-Wurzel

Sow 6 to 8 pounds to acre.

Danish Sludstrup. A long, reddish yellow variety. Lb. 75c, 10 lbs. \$6.00.

Golden Tankard. An enormous yielder per acre. Flesh deep yellow. Lb. 75c, 10 lbs. \$6.00.

Mammoth Long Red. The largest and heaviest cropper of all the Mangels. Lb. 75c, 10 lbs. \$6.00.

Buckwheat

48 pounds to the bushel. Sow 1 bushel to the acre.

Japanese. Very prolific. Pk. \$1.00, bu. \$3.00.

Silver Hull. Makes fine white flour. Pk. \$1.00, bu. \$3.00.

Field Corn

Plant 8 to 12 quarts per acre in hills; for fodder or ensilage, in drills, 1 to 1½ bushels per acre; and for soiling, 3 to 4 bushels per acre, broadcast.

Flint Varieties

Early Canada. One of the earliest yellow varieties; ear small; in ordinary seasons the crop will be fully ripened in August. Pk. \$1.25, bu. \$4.00.

Longfellow. The standard variety in this section; long ears, small cob, bright yellow color, and medium early. Pk. \$1.25, bu. \$4.00.

Dent Varieties

Leaming. Yellow Dent variety, with large, deep grain of dark orange color; excellent for ensilage. Pk. 85c, bu. \$2.50.

Pennsylvania Sweepstake Corn. This variety of corn will mature quicker than any other variety; the foliage extends to the ground and the stalks are sturdy and tall. A heavy cropper. Pk. \$1.25, bu. \$4.00.

Pride of the North. The earliest Yellow Dent Corn in cultivation; a safe sort for high latitudes. Pk. \$1.00, bu. \$3.00.

Fodder and Ensilage Varieties

Eureka. Grows from 10 to 15 ft. high and produces a rich, heavy growth. Pk. \$1.00, bu. \$3.00.

Evergreen Sweet Fodder. For cutting green and feeding to stock this variety excels all others in tenderness, sweetness and nutriment. Pk. \$1.75, bu. \$6.00.

Millet

German, or Golden. A valuable annual hay and fodder crop, more productive and coarser than the Hungarian. Medium early, 4 to 5 feet high. Sow 1 bushel to the acre. Pk. \$1.25, bu. \$4.00.

Japanese (Panicum Crus-galli). Grows taller and stools out more freely than the common Millet; very productive. If sown early and cut, usually produces a good second crop. Sow 20 lbs. per acre. Lb. 10c, 100 lbs. \$8.00.

Hungarian Millet (Panicum germanicum). An annual forage plant, early and productive, growing 2 to 3 feet high, with an abundance of foliage, often yielding 2 to 3 tons per acre. Sow 1 bushel to the acre. Pk. \$1.25, bushel, \$4.00.

Oats

Sow 2 to 3 bushels to the acre, 32 pounds to the bushel.

Canadian Cluster. Heavy, with stiff straw; yields well. Pk. 50c, bu. \$1.50.

Montana. A choice white variety. Pk. 50c, bu. \$1.50.

Welcome. A very productive white variety, with extra strong, straight, straw. Pk. 50c, bu. \$1.50.

Peas

Canada Field. Valuable when sown with Oats as a green fodder. Also makes good ensilage. Sow 2 bushels Oats and 1 bushel Peas per acre. Pk. \$1.50, bu. \$5.00.

Clay, or Wonderful. Has matured in New England. Sow as early as May 10th or as late as July 1st, 1 bushel to the acre in drills; 2½ bushels to the acre broadcast. Pk. \$1.25, bu. \$4.00.

New Era. Early and large yielder. Pk. \$1.25, bu. \$4.00.

Whippoorwill. One of the earliest. Pk. \$1.25, bu. \$4.00.

Rape

50 pounds per bushel

Dwarf Essex. Fine for sheep pasture; valuable as a soil enricher. Plant in June or July in drills at the rate of 3 lbs. per acre, broadcast 5 lbs. per acre. Lb. 15c, 100 lbs. \$10.00.

Rye

Sow 1½ bushels per acre (56 lbs. per bu.).

Rosen Winter Rye. The most desirable variety for northeast conditions, either summer or autumn planting. Pk. 75c, bu. \$2.25.

Spring Rye. Selected re-cleaned grain in limited supply. Pk. 85c, bu. \$3.00.

Sorghum

Sow 25 pounds per acre in drills; for dry fodder, broadcast 100 pounds per acre.

Early Amber Sugar Cane. Will ripen where Indian corn matures. Lb. 25c, 100 lbs. \$20.00.

Red Kaffir Corn, or Sorghum. Non-saccharine. The plants, which are stocky and perfectly erect, cure into excellent fodder, or may be fed green during all stages of growth. Lb. 20c, 100 lbs. \$12.00.

White Kaffir Corn. Lb. 20c, 100 lbs. \$12.00.

Sudan Grass

The ground should be prepared as for corn and the seed not planted till soil becomes warm. Sown broadcast use 16 to 24 pounds of seed per acre; if planted in drills, 18 to 24 inches apart, from 4 to 6 pounds per acre will be sufficient. Lb. 15c, 100 lbs. \$10.00.

Sunflower

Sow 6 to 8 pounds per acre (25 pounds per bushel).

Mammoth Russian. Very productive, large heads with large seeds. Valuable for poultry. Lb. 20c, 100 lbs. \$15.00.

Vetches or Tares

Weight, 60 pounds per bushel.

Vetches, or Tares, Spring (Vicia sativa). Pealike plant grown to some extent for feeding to stock. Frequently sown with Oats. Sow 1 to 1½ bushels per acre. Pk. \$1.75, bu. \$6.00.

Vetches, Sand, Winter, or Hairy (Vicia villosa). Thrives on poor, arid, sandy soil, and can be sown either in spring or fall. Sow 40 to 50 pounds per acre. Pk. \$2.75, bu. \$10.00.

Wheat

Sow 1½ bushels per acre (60 pounds per bushel).

Spring (Marquis). Pk. \$1.00; bu. \$3.00.

Winter (Klondyke Bald). White grain. Pk. \$1.00; bu. \$3.00.

All Grains sold f. o. b. Boston. Bags extra. Prices subject to market changes. Samples sent on request.

Summer Flowering Bulbs and Tuberos Roots

LILIES

In the flower garden Lilies rank first in importance. They are stately and beautiful, matchless in form and variety of color, while possessing the most agreeable perfume, and for general effect they have no rivals. Plant 6 inches deep in a well drained, deep, loamy soil made rich with thoroughly rotted manure, and an inch of clean sand placed under and over the bulbs when setting.

Each Doz. 100

Auratum (Golden Rayed Lily of Japan). Large, pure white flowers, with crimson spots and a golden band through the center of each petal. 2 to 4 ft. high, blooming from July to October. Mammoth bulbs.. \$0.60 \$5.00 \$40.00

Henryi (Yellow Speciosum). A beautiful Lily from China. Rich apricot-yellow, reddish brown spots. 5 ft. July and August.. .60 5.00 40.00

Speciosum album. Large, fragrant, pure white35 3.50 25.00

Speciosum magnificum. Rich red, heavily spotted; much larger and richer colored than the other varieties. Mammoth bulbs45 4.00 30.00



Regal Lily.



Lilium Tigrinum Splendens.

Each Doz. 100

Speciosum melpomene. White, shaded with rich blood-crimson; heavily spotted. Mammoth bulbs \$0.45 \$4.00 \$30.00

Speciosum rubrum or roseum. White, shaded and spotted rosy crimson; fragrant. Mammoth bulbs45 4.00 30.00

Regale (Regal Lily). White, slightly suffused with pink, with a beautiful shade of canary-yellow at the center of the trumpet. Hardy60 5.00 40.00

Tigrinum splendens (Tiger Lily). Orange-salmon, spotted; the finest form30 2.75 20.00

Lily-of-the-Valley

(Convallaria)

Grey's Perfect Forcing Pips. The finest grade of pips that come to this country and especially selected for our large private trade, which demands only the best for forcing throughout the year. We carry these in cold storage and can furnish them at any time. Three to four weeks are usually allowed for forcing cold storage pips into flower. Per case of 250, \$18.00.

GLADIOLUS

By F. F. Rockwell

We highly recommend this book to anyone interested in this popular flower.

\$1.25 per Copy

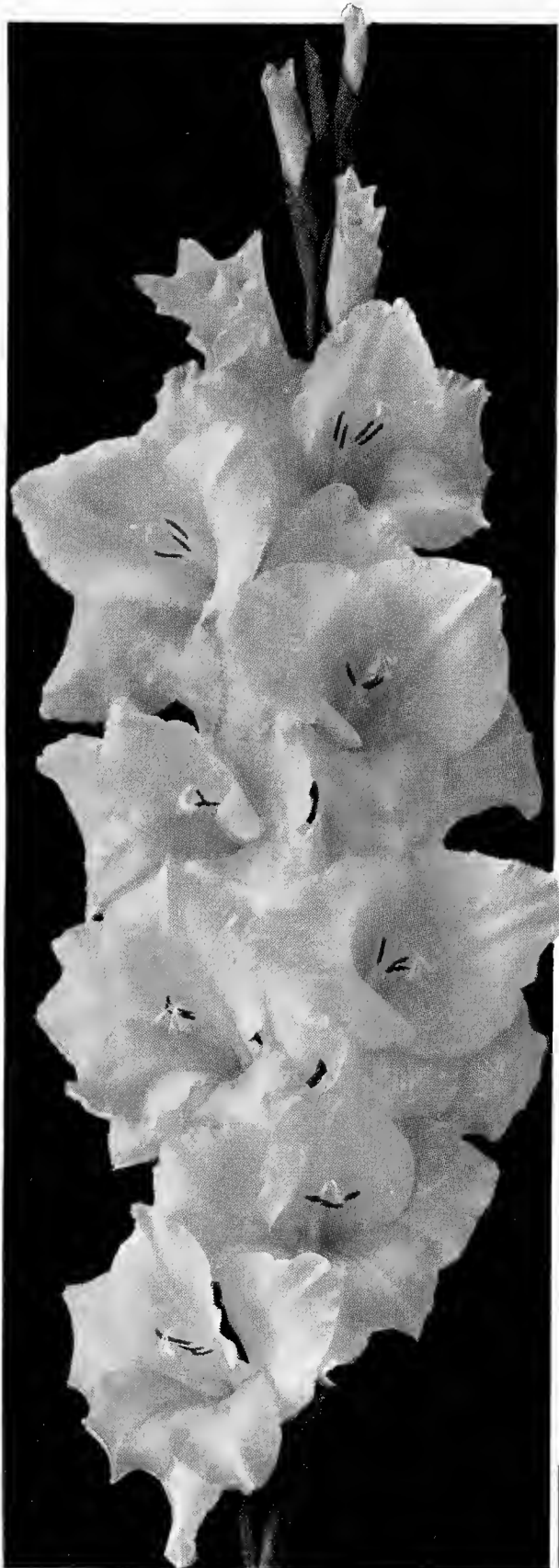

Gladiolus the Aristocrats of the Garden

For general garden decoration and for cut flowers the Gladiolus is deserving of special attention. Very effective for massing in large beds where a brilliant effect is desired. Of easiest culture, seldom disappointing and immune to insect pests. They thrive in well prepared, enriched loam, planted 3 inches deep and 6 inches apart. Frequent watering is very beneficial. We stock first size bulbs only. Six bulbs offered at the dozen rate.

	Doz.	100
Albatross. Very large pure white on tall spike of good standing	\$1.10	\$8.50
Annie Laurie. White, flushed pink, semi-ruffled, the ruffling of a very fresh carmine-pink60	4.50
Ave Maria. Light blue with small purple blotches90	6.50
Baron Hulot. Deep violet-blue; one of the finest75	5.50
Berty Snow. Large florets of beautiful clear lavender. Tall, straight spike and strong habit75	5.00
Betty Nuthall. Beautiful salmon-pink, with yellow throat markings75	5.50
Break o' Day. A clear light pink. In habit and growth very similar to Halley70	5.00
Carmen Sylva. A pure white except for slight violet markings in throat. One of the best whites60	4.50
Charles Dickens. Rich purple-violet. Best of the color85	6.00
Coryphee. Beautiful pink, similar to an Ophelia rose	1.00	7.00
Crimson Glow. Deep crimson, lighter in throat. Exhibition variety55	4.00
Dr. F. E. Bennett. A very large, fiery red. Considered Diener's best red70	5.00

The World Renowned
PICARDY

GLADIOLUS—Continued

	Doz.	100
E. I. Farrington. A very beautiful rich self yellow. Many florets of fair size open at one time. One of the most popular yellows	\$1.00	\$ 7.00
Fern Kyle. Kunderd's massive creamy white exhibition variety60	4.50
Giant Nymph. A giant in growth and flowers. Light rose-pink with creamy yellow throat60	4.50
Gloriana. A very fine large salmon, with yellow throat. No other markings60	4.50
Golden Frills. Deep rich daffodil-yellow, frilled edges. Light red line on lower petals60	4.50
Golden Dream. Clear deep yellow; flowers recurved and distinct55	4.00
Heavenly Blue. Very tall straight spike of delicate sky blue	1.75	12.00
Marietta. A delicate shade of light salmon, blended with light orange. A marvelous Gladiolus85	6.00
Marmorata. Lavender-gray color, with petunia colored blotch. A fine exhibition variety90	6.50
Mary Pickford. Delicate creamy white, throat sulphur-yellow. One of the best. .60	.60	4.50
Mother Machree. Beautiful combination of wine-tinted lavender, overlaid with salmon-pink	1.10	8.50
Minuet. New self colored lavender; rich, very large flower of heavy substance. . .90	.90	6.50
Mrs. F. C. Hornberger. A fine white variety. Nicely ruffled, wide open blooms90	6.50
Mrs. F. C. Peters. Beautiful shade of rosy lilac, crimson blotched, bordered white on lower segment60	4.50
Mrs. P. W. Sisson. One of the best creamy, light pink varieties90	6.50
Mrs. Van Konynenburg. Aniline-blue of strong growth. A trifle darker than Heavenly Blue90	6.50
Orange Wonder. One of the best in the orange class. Vigorous grower85	6.00
Osalin. Beautiful coral-pink with soft orange markings in the throat70	5.00
Pearl of California. Flower is of the clearest softest La France pink, blending to a rosy white throat, with 8 to 12 open at a time	1.00	7.00
Picardy. One of the most outstanding varieties in existence. Soft shrimp pink, with flesh-pink lip. Blotch of light flesh pink shading to shrimp-pink at edges. Well placed on tall, strong spike	1.00	7.50
Pelegrina. The newest and best of dark blues. Very tall grower	1.50	12.00
Primrose Princess. This is without doubt the best new yellow. Large, clear, light yellow. An exhibition novelty90	6.50

Richard Diener. (New). This variety has 10 to 12 blooms well placed, open at one time. Very live rose-salmon, with creamy yellow center. Considered the finest variety of its color \$1.00 \$ 7.00

Sweet and Lovely. The outstanding feature of this variety is the delicate fragrance it possesses. It is not readily noticeable in the garden, but develops after being cut and taken in the house. They should be cut as the buds are opening. Blooms are best described as an attractive saffron, tinted with orange, measuring 4 inches across \$2.00 \$15.00

Tawny. Very tall spike (50 inches), seven large flowers open. Color deep rose-apricot, faintly laid with pale rose-violet at the edges. Remarkably silky texture \$2.00 \$15.00

W. H. Phipps. Beautiful flesh-pink with about 22 blooms to a spike and nearly all opening at a time90 6.50

Primulinus Varieties

The following list of Primulinus we highly recommend. The colors are mostly yellows, oranges, pinks, etc., and they are specially desirable as cut flowers for vase work.

	Doz.	100
Ada de Poy. Very beautiful, new Primulinus hybrid of clear apricot with bronze shadings. Slightly ruffled. Elegant exhibition variety	\$0.75	\$5.00
Affame. An outstanding red Primulinus variety. Enormous flowers on tall spike .70	.70	5.00
Alice Tiplady. A soft burnt orange. The queen of the Primulinus type55	4.00
Apricot Glow. One of the finest of the Primis. Beautiful warm buff, edged soft apricot60	4.50
Ethelyn. One of the best Primulinus varieties. A beautiful shade of orange-yellow, petals tipped with bronze55	4.00
White Butterfly. (New). Beautiful Kunderd variety. Pure white. Butterfly form	1.00	7.00
Mixture. Containing a fine collection of popular named varieties50	3.50

Columbia Prize Mixture

Our choicest mixture, selected from the newer and better varieties, including only colors which harmonize well together.

Doz., 75c; 100 for \$5.50; 1000 for \$50.00.

Home Garden Mixture

A superior mixture including all colors and types. Doz., 50c; 100 for \$3.00; 1000 for \$25.00.

Summer Flowering Bulbs—Continued

Acidanthera

Bicolor. A summer flowering bulb, having beautiful, creamy white fragrant flowers with a purple-maroon blotch at base of petals. Doz. \$2.00, 100 \$15.00.

Begonias

Splendid pot plants for the house or greenhouse, and especially valuable for bedding, flowering in the greatest profusion throughout the summer. For bedding they should be started in hotbed in March and April.

Single Tuberos Rooted

Separate Colors. Crimson, rose, orange, pink, white, yellow, salmon, scarlet. Each 25c, doz. \$2.75, 100 \$20.00.

Double Tuberos Rooted

Separate Colors. Crimson, orange, rose, pink, white, yellow, salmon, scarlet. Each 25c, doz. \$2.75, 100 \$20.00.

Cannas, Dormant Roots

Large-Flowering French Mixed. Finest varieties. Each 12c, doz. \$1.25.

Dahlias

Special Dahlia Catalog mailed on application.

Gloxinias, Large Flowered

Delivered January.

Magnificent for house or conservatory, producing in great profusion flowers of the richest and most beautiful colors. They succeed best in sandy loam and peat, and require a moist heat.

Separate Colors. Dark purple, white with scarlet border, scarlet, rose, white with purple border. Each 50c, doz. \$5.00.



Montbretias.

Hyacinthus Candicans

A hardy summer-flowering Hyacinth with spikes of white bell-shaped flowers. Height 3 feet. Doz. \$1.10, 100 \$8.00.

Montbretias

One of the best and brightest summer-flowering bulbs, sure of becoming firm favorites wherever grown. Planted in clumps from April to June they produce numerous graceful spikes of brilliant star-shaped flowers. Hardy with protection.

- Aurea.** Pure orange-yellow. Doz. \$1.00, 100 \$7.00.
- George Davison.** Large orange-yellow. Doz. \$1.00, 100 \$7.00.
- Golden West.** Tall branching spikes and large open flowers of a most beautiful golden yellow. Doz. \$1.10, 100 \$8.00.
- Hereward.** Late, large flowering, yellow, shaded orange on the outside. Doz. \$1.10, 100 \$8.00.
- His Majesty.** A vigorous new seedling with handsome foliage. Outside bright red, inside scarlet with yellow center. Doz. \$2.50, 100 \$18.00.
- James Coey.** Vermillion-scarlet with clear luster, center yellow with crimson blotches. Doz. \$2.00, 100 \$15.00.
- Lord Nelson.** Deep orange-scarlet, externally crimson, eye yellow. Doz. \$1.25, 100 \$9.00.
- Nimbus.** Golden, edged with a crimson ring around the base. Doz. \$2.00, 100 \$15.00.
- Rosea.** Clear pale pink. Doz. \$1.00, 100 \$7.50.
- Una.** Inside of flowers apricot. Outside red with crimson blotch in center. Doz. \$2.00, 100 \$15.00.
- Splendid Mixture.** A well blended mixture of colors. Doz. 60c, 100 \$4.00.

Tuberose

Delivered March

Double Excelsior Pearl. Summer flowering bulbs, producing tall spikes of fragrant, double white flowers. Start in pots in rich loam and transplant into the garden. Doz. \$1.10, 100 \$8.00.



Single Tuberos Rooted Begonia.

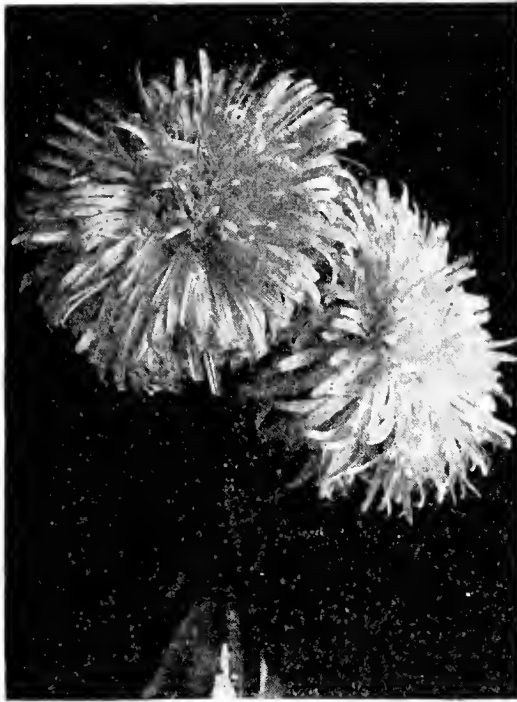

Asters.

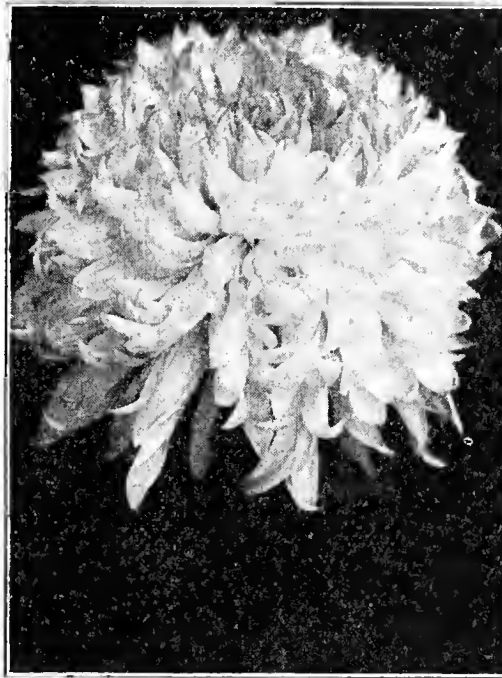

Chrysanthemums.



Verbena.

Foliage and Flowering Plants

For Summer Bedding

	Doz.	100		Doz.	100
Abutilon	\$2.50	\$19.00	Daisy, Paris Golden. Single yellow	\$3.00	\$23.00
Alternanthera. Dwarf scarlet	1.25	8.50	Daisy, Paris White. Single white	3.00	23.00
Alternanthera. Dwarf yellow	1.25	8.50	Feverfew, Double White	1.75	12.50
Achyranthes. Bright crimson	1.50	10.00	Feverfew, Golden Feather	1.25	8.50
Achyranthes. Green and white	1.50	10.00	Fuchsias. In variety	3.00	23.00
Ageratum. Blue or white	1.75	12.50	Geranium, Double Varieties	3.00	23.00
Alyssum, Double White	1.25	8.50	Geranium, Single Varieties	3.00	23.00
Alyssum, Single White	1.00	7.50	Geranium, Ivy-Leaved Sorts	3.00	23.00
Antirrhinum (Snapdragon). Assorted	1.75	12.50	Heliotrope, Giant Elsa	2.75	22.00
Asters. Assorted colors. Double50	3.50	Heliotrope, Dark and light	2.25	17.00
Asters. Double white50	3.50	Lantanas. In variety	2.00	15.00
Begonia. Tuberous-rooted mixed	4.00	30.00	Lobelia. Dark blue, for bedding	1.25	8.50
Begonias. In variety	2.50	18.00	Marigold, Dwarf French	1.25	8.50
Caladium esculentum	3.00	23.00	Mignonette, Large-Flowered	1.00	7.50
Calendula, Orange King	1.50	10.00	Nicotiana affinis. White, fragrant	1.25	8.50
Cannas, Dwarf Large-Flowering French	2.00	15.00	Nicotiana sanderae. Carmine	1.25	8.50
Cannas. In the following varieties: Ambassa- dor, City of Portland, King Humbert, Yellow King Humbert, King Midas, Mrs. Alfred Conard, The President, Hungaria	2.25	17.00	Pansy. Special strain, extra choice70	5.00
Centaurea candidissima	1.50	10.00	Petunia, Double. Assorted colors	2.25	17.00
Centaurea gymnocarpa	1.50	10.00	Petunia, Single. Assorted colors	1.25	8.50
Chrysanthemums. Our collection of these beau- tiful fall blooming plants embraces the best of the old and newer introductions	2.50		Phlox drummondii. Assorted	1.25	8.50
Cobaea scandens	2.25	17.00	Ricinus (Castor-Oil Bean)	1.75	12.50
Coleus. Fine varieties	1.25	8.50	Salpiglossis. Mixed colors	1.50	10.00
Cosmos. Early flowering	1.00	7.50	Salvia splendens. Best scarlet	1.75	12.50
Daisy, Double English. Assorted85	6.00	Torenia fournieri. Blue	1.50	10.00
			Verbena. Assorted colors	1.25	8.50
			Verbena. Lemon-scented	3.00	23.00
			Vinca alba and rosea (Flowering Vinca)	1.25	8.50
			Vinca variegata (Periwinkle). Trailing	2.50	19.00
			Wallflower, Mixed	1.75	12.50
			Zinnia, Columbia Prize. Assorted	1.00	7.50

PALMS, FERNS AND GREENHOUSE PLANTS.
Quotations on application.

Many other varieties not mentioned in this list can be furnished at regular prices.

Select List of Hardy Perennial Plants

We can furnish a good selection of hardy plants, which may be expected to give successional bloom throughout the spring, summer and fall months, and, if the choice is left to us, will take special care to select such varieties as afford the most satisfactory results.

We also furnish estimates on the laying out, planting and improvement of private estates, and furnish experienced gardeners to carry out the work. We shall be pleased to correspond with those contemplating improvements or planting hardy stock of any sort.

PARCEL POST—Add six cents for one plant, two cents for each additional plant.

The price of all perennial plants on this and succeeding pages: 25c each, \$2.50 per doz., \$18.00 per 100, except as otherwise noted. Six perennials of one kind are entitled to the doz., and twenty-five of one kind to the hundred rate.

- ACHILLEA** (Milfoil or Yarrow).
ptarmica fl. pl. var., **The Pearl**, Double white flowers, most useful for cutting. June to October.
- ACONITUM napellus** (Monkshood). Dark blue flowers from July to September. 3 ft. Each 35c.
fischeri. A dwarf variety with pale blue flowers. September, 18 in. Each 35c.
- Sparks' Variety**. The darkest blue of all. Flowers in June.
- AJUGA reptans** (Bugle Plant). 6 in. Blue. Excellent for rock work, covering banks and shady places. May.
- ALYSSUM saxatile compactum** (Basket of Gold). 1 ft. A grand plant for the rockery or border. April to June.
- ANCHUSA italica**, **Dropmore Variety**. 3 to 4 ft. A lovely shade of gentian blue, and blooms the entire season.
myosotidiflora (Forget-Me-Not Flowered Anchusa). Grows 12 inches high and is covered during April and May with sprays of rich blue flowers.
- ANEMONE**, *japonica alba*, 2 to 3 ft. Flowers large, white. One of the best. September to November.
japonica, **Queen Charlotte**. 2 ft. Large, semi-double, silvery pink. September.
japonica, **Whirlwind**. 2 to 3 ft. Large, semi-double, pure white. September.
Hupehensis. Pink. September and October. 2 ft.

- ANTHEMIS tinctoria** (Golden Marguerite). 2 to 3 ft. Lemon-yellow. June to October.
- AQUILEGIA** (Columbine).
Long-Spurred Hybrids. 2 ft. These embrace all the colors of the long-spurred type. May to July.
chrysantha (Golden). 2 to 3 ft. Yellow long-spurred flowers. May to August.
caerulea (Rocky Mountain Blue Columbine). 2 ft. Long spurs, blue and white flowers. May to July.
- ARABIS alpina** (Rock Cress). 6 in. Early white spring-flowering plants. Fine for rock work and borders. April to June.
- ARMERIA maritima** (Sea Pink or Thrift). 1 ft. A fine plant for rockeries or edgings; flowers bright pink.
- ASCLEPIAS tuberosa** (Butterfly Weed). One of the showiest of our native flowers; brilliant orange. June to July.
- ASTER** (Michaelmas Daisies). These are our most showy fall flowers.
Blue Gem. Double, dark blue. 4 to 5 ft. September and October.
Climax. 5 ft. Light bluish lavender. August to October.
Peggy Ballard. 3 ft. Large pyramidal sprays of double rosy mauve flowers.
Queen Mary. Blue, tinted lavender flowers, 2½ inches across. 3½ ft.
St. Egwin. 2½ ft. Bright pink. September and October.
White Lady. Large white flowers.
Ypres. Rosy red. 2 to 3 ft.

- BAPTISIA australis** (False Indigo). 2 ft. Long racemes of dark blue flowers. June to July.
- BOLTONIA asteroides** (False Chamomile). 5 to 6 ft. Fine late-flowering perennials. Aster-like white flowers. August and September.
latisquama. 4 ft. Flowers clear lavender; fine for cutting.
- CAMPANULA carpatica** (Harebell). 9 in. Erect blue flowers, useful for edgings. June to September.
carpatica alba, 9 in. Pure white.
medium (Canterbury Bells). 3 ft. Biennial. Flowers blue, white and rose. Separate colors. June and July.
medium calycanthema (Cup-and-Saucer). Biennial. Separate colors.
persicifolia (Bellflower). Peach-leaved. 2 ft. Blue. June to August.
persicifolia alba. 2 ft. White. June to August.
rotundifolia (Blue Bells). 1 ft. Blue. June to August.
- CENTAUREA montana**. 20 in. Large purple flowers. Fine for cutting. June.
- CERASTIUM tomentosum** (Snow-in-Summer). 5 to 6 in. Low growing plant. Silvery foliage, white flowers; fine for rockeries.
- CHELONE lyonii** (Turtlehead). 2 ft. Showy deep red flowers, bearing Snapdragon-like blooms and spikes. August to September.



Aquilegia.

Hardy Perennial Plants

CHEIRANTHUS, Alloni. (Siberian Wallflower.) Brilliant orange flowers in June. 12 inches.

CHRYSANTHEMUMS (Hardy Garden Varieties)

Coreanum (Korean Chrysanthemum). 2 to 3 ft. September and October. A superb garden plant, coming into bloom before the first frosts. Flowers are single, 2 to 3 inches across, white at first, acquiring a rose-pink tinge.

- Alice Howell.** Orange-yellow. Early.
- Barbara Cummings.** Double yellow. Early.
- Brown Bessie.** Pompon. Reddish bronze.
- Crimson Splendor.** Rich crimson-maroon. Late Sept.
- Daybreak.** Large shell pink, single.
- Frances Whittlesey.** Garnet-bronze. Large double aster-flowered type.
- Glory of Seven Oaks.** Large yellow. Early.
- Jean Treadway.** Large pink. Early.
- L'Argenteuillais.** Deep chestnut. Early.
- Model.** Light yellow pompon.
- Mrs. Nellie Kleris.** Deep pink. Early.
- Oconto.** Japanese. White. Large. October 15.
- October Girl.** Pink.
- Old Homestead.** Pink. Large.
- Ruth Hatton.** Rosy pink.
- Skibo.** Golden yellow. Pompon. October 20.
- Tennyson.** Large chestnut brown.
- Vivid.** Rosy crimson. Early.
- Yellow Button.**

Burbank's Shasta Daisy. 1½ ft. Large snow-white flowers; blooms all summer.

COREOPSIS. One of the best blooming all-summer plants we have.

lanceolata grandiflora. 2 ft. Large golden yellow.

DELPHINIUM (Larkspur).

- belladonna.** 3 ft. Sky blue.
- bellamosum.** 3 ft. Dark blue.
- chinensis.** 2 ft. Gentian blue. Blooms all summer.
- chinensis album.** 2 ft. Blooms all summer.

Choice Mixed English Hybrids.

Hollyhock Strain (Wrexham). A new plant race, double and semi-double. Many new and lovely shades. Mixed. 75c each.

DIANTHUS plumarius (Garden Pinks). A valuable and showy border plant; single and double. Very fragrant. May to August.

barbatus (Sweet William). 1 to 1½ ft. Mixed varieties. June and July.

deltoides (Maiden Pink). A dwarf trailer with rosy pink flowers. June to August.

Rose de May. Dwarf single pink.

DIANTHUS barbatus alpina compacta. A very fine dwarf Sweet William. Suitable for edging and rockeries. New.

DICENTRA, or Dielytra (Bleeding Heart).

spectabilis. 2 ft. An old-fashioned favorite. May and June. 50c each.

DICTAMNUS fraxinella (Gas Plant). 2½ ft. Rosy crimson, fragrant foliage. May to July. 50c each.

DIGITALIS (Foxglove). The flower heads are over 3 ft. long, crowded with big, bell-shaped blossoms. Colors range from white and shell-pink to deepest rose.

DORONICUM excelsum (Leopard's Bane). Large, bright yellow daisy-like flowers. Early.

ECHINOPS ritro (Globe Thistle). Showy thistle-like plants with metallic-blue globular flowers. 3 ft. July to Sept.

FUNKIA (Plantain Lily). A beautiful class of plants growing well in partial shade.

subcordata grandiflora (White Day Lily). 2 ft. A pure white trumpet-flowered and fragrant species. July to September.

undulata variegata. 1 ft. Beautiful variegated foliage, flowers lilac.

GAILLARDIA grandiflora (Blanket Flower). 2 ft. Large crimson and gold; good for cutting. June to November.

GYPSOPHILA paniculata (Baby's Breath). 2 ft. An old-fashioned favorite; very useful, pure white flowers. June to August.



Hardy Chrysanthemums.

Bristol Fairy. Double. 50c each.

Repens. A creeping variety with tiny white flowers. A good rockery plant.

HELENIUM autumnale rubrum. 5 ft. Reddish brown, aster-shaped flowers; profuse bloomer. August to October.

autumnale superbum. 5 ft. Immense heads of golden yellow flowers. August to October.

Riverton Gem. Old gold suffused with terra cotta. August to October.

HELLEBORUS niger (Christmas Rose). Pot grown plants. \$1.00 each.

HELIANTHUS (Sunflower). These form a very important group of bold, showy autumn flowering plants.

maximiliani. The latest of all. Golden yellow flowers in graceful sprays in October. Fine for cutting. 6 ft.

HELIOPSIS pitcheriana (Ox-Eye). 3 ft. Very desirable, blooming all through the summer. Deep orange-yellow.

Plants on this page 25c each, \$2.50 per doz., \$18.00 per 100, except as noted. Six plants of a variety will be furnished at the dozen rate; less than six at the single rate.

Hardy Perennial Plants

- HEMEROCALLIS** (Day Lily). Does well in partial shade and moist places.
- Apricot.** Fine orange-yellow, large and free flowering. June and July. 2½ ft.
- flava.** 3 ft. Golden yellow. May and June.
- thunbergi.** Very fragrant flowers; lemon-yellow, blooms in late spring.
- HEUCHERA sanguinea.** 1½ ft. Graceful spikes of delicate coral-red flowers. June and July.
- HIBISCUS, Crimson Eye** (Mallow). 4 ft. Large, pure white, with crimson spot in center. July and August.
- moscheutos roseus.** 4 ft. Pink. July and August.
- moscheutos albus.** 4 ft. White. July and August.
- HOLLYHOCKS.** Finest double variety. Separate colors or mixed.
- Finest Single Varieties.**
- IBERIS sempervirens** (Candytuft). 1 ft. Evergreen foliage; good for borders. May and June.
- IRIS germanica** (Garden Iris). They form a group unparalleled in beauty. Every shade of color may be found among them, and they will thrive in almost any soil or situation.
- Caprice.** Chinese violet.
- Florentina alba.** Large fragrant white flowers.
- Gertrude.** Dark blue.
- Japanesque.** Lavender and white.
- Lent A. Williamson.** Soft lavender-violet; falls royal purple.
- Lorelei.** Falls marine-blue veined with white and bordered with yellow.
- Ma Mie.** White, edged blue.
- Mandraliscae.** Lavender-purple.
- Mme. Chobaut.** Buff and wine.
- Nibelungen.** Fawn yellow, falls blue.
- Pocahontas.** White, penciled lavender, nearly double.
- Prospero.** Lavender standards, purple falls.
- Rhine Nixe.** White and blue.
- Sans Souci.** Golden yellow.
- Seminole.** Violet-rose and crimson.
- Shekinah.** Pale yellow.
- IRIS, Japanese** (Iris Kaempferi). 35c each, \$3.50 per doz. Double, except where noted.
- Blue Danube.** Blue with pure white veins, yellow center.
- Gold Bound.** White; yellow markings.
- Hercule.** Clear lilac-blue.
- Mahogany.** Mahogany-red.
- Oniga-Shima.** Violet-purple, golden center.
- Purple and Gold.** Violet-purple.
- Uchiu.** Blue with golden center, and white.
- LATHYRUS latifollus** (Everlasting Pea). 5 ft. Flowers large, bright red. July to August.
- LAVANDULA vera.** True lavender. 2 ft. Fragrant bluish flowers; foliage gray, with fragrance of lavender.
- LIATRIS pycnostachya** (Blazing Star). 4 ft. Showy spikes of rosy purple flowers. July to September.
- LILY-OF-THE-VALLEY.** Strong clumps. 50c each, \$5.00 per doz.
- LINUM perenne.** 18 in. Light blue flowers, which are produced all summer.
- LOBELIA cardinalis** (Cardinal Flower). 3 ft. Cardinal-red. August to October.
- LYCHNIS chalconica** (London Pride). 3 ft. Brilliant heads of crimson flowers. June to September.
- viscaria.** 1½ ft. Single, scarlet flowers, brilliant. July and August.
- LYTHRUM roseum superbum.** 3 ft. Spikes of deep rose-colored flowers. September.
- MONARDA didyma** (Oswego Tea). 3 ft. Aromatic foliage and bright scarlet flowers. June to September.
- MYOSOTIS palustris** (Forget-Me-Not). 10 in. Flowers all summer. Fine blue.
- NEPETA mussini.** Dwarf, covered with light blue flowers. Fine for rock garden. May to September.
- OENOTHERA** (Evening Primrose).
- youngi.** 18 in. Bright yellow. June to September.
- PAPAVER orientale** (Oriental Poppy). 3 ft. Brilliant scarlet with black center; very showy. June.
- Mrs. Perry.** Salmon-rose.
- nudicaule** (Iceland Poppy).
- PENTSTEMON barbatus torreyi** (Beard Tongue). 4 ft. Bright scarlet flowers. July to September.
- digitalis.** 3 ft. Pure white. July and August.
- PEONIES** (Paeonia). One of the hardiest flowering plants and rivaled only by the Rose.
- Alsace-Lorraine.** White, much like the white Pond Lily. Late. \$1.50 each.
- Couronne d'Or.** Pure white globular flowers, with amber-yellow stamens. Late. \$1.00 each.
- Dorchester.** Large and compact. Pale hydrangea-pink. Fragrant; late. \$1.00 each.
- Dorothy Allison.** Bright, fresh pink; dwarf habit. Mid-season. Single. \$2.00 each.
- Duchesse de Nemours.** Medium sized, pure white bloom. Strong, free bloomer; fragrant; early. 75c each.
- Eugenie Verdier.** Flesh pink; extra fine variety, late. \$1.50 each.
- Felix Crousse.** Large, globular bloom. Brilliant red and a free bloomer. Fragrant; midseason. \$1.00 each.
- Festiva Maxima.** Very large; pure white center, petals tipped with bright crimson. Midseason. 75c each.
- Georgiana Shaylor.** Pale pink flecked with crimson; fine blooms late in the season. \$1.50 each.
- Ginette.** A flesh pink variety, very fragrant. Early. \$1.50 each.
- James Kelway.** A pure white variety, blooms early mid-season. \$1.50 each.

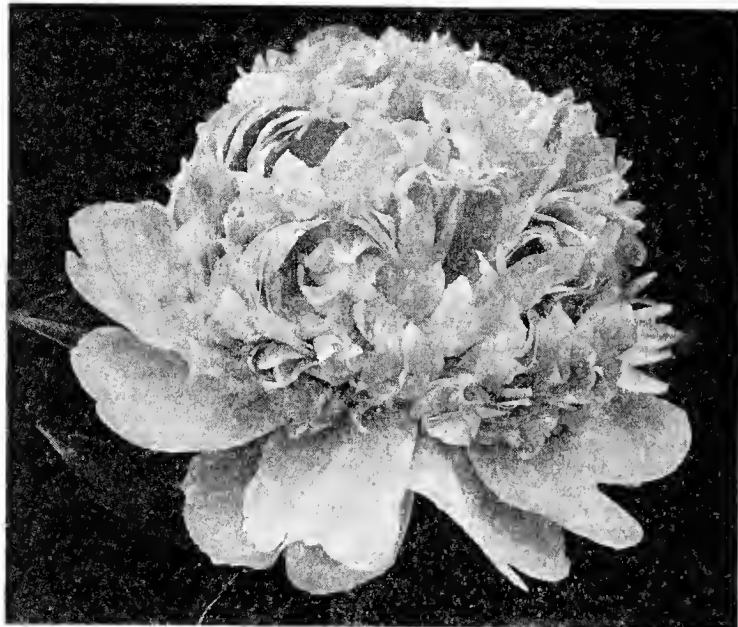

Mons. Jules Elle Peony.

Plants on this page, 25c each, \$2.50 per doz., \$18.00 per 100, except as noted. Six plants of a variety will be furnished at the dozen rate; less than six at the single rate.

Hardy Perennial Plants

PEONIES—Continued.

- Lady Lilian Ogle.** Early single, pure white, fragrant. \$1.00 each.
Le Cygne. Pure milk white, incurved petals, midseason. \$3.00 each.
Madame de Verneville. Very large; pure white with center petals blush, tipped carmine. 75c each.
Monsieur Jules Elie. Large, compact. Pale lilac-rose with silvery reflex; fragrant, midseason. \$1.50 each.
Norfolk. Deep shell-pink with cup-shaped petals. Late. \$1.00 each.
Venus. Delicate shell-pink, compact bloom. \$1.50 each.
Walter Faxon. Large blooms; bright rose, deepening toward the center; fragrant; midseason. \$3.00 each.

PAEONIA officinalis, alba, rubra, rosea. \$1.00 each.

PEONIES, Mixed.

- PHLOX paniculata** (Hardy Perennial Phlox). A succession of flowers of greatest beauty, from early July until frost, in softest tones of pink and rose, salmon and white in great paniced blooms.
Annie Cook. Flesh pink. Tall.
B. Conite. French purple. Medium.
Beacon. Bright red.
Betty Lou. Orange-scarlet.
Comus. Cherry-red.
Enchantress. Salmon-pink. Medium.
Europe. White; decided crimson eye. Tall.
Feuerbrand. Brilliant crimson-scarlet.
Frau Antoinette Buchner. Largest pure white. Medium.
Jeanne d'Arc. Pure white; late. Medium.
Jules Sandeau. Large salmon-pink.
Maid Marion. Soft lavender, large flower. Medium.
Miss Lingard. White with pale pink center. Early.
Mrs. Jenkins. Beautiful clear white. Medium.
Pantheon. Brilliant rose, very effective. Tall.
Rheinlander. Beautiful salmon-pink. Medium.
R. P. Struthers. Bright pinkish salmon. Crimson eye.
Rijnstroom. Color of Paul Neyron rose. Tall.
Special French. Beautiful clear pink. Tall.
Thor. Deep salmon-pink. Tall.
Von Hochberg. Deep crimson.

- PHLOX divaricata.** 1 ft. Dwarf. Pale blue. Native variety. May and June.
subulata (Moss Pink). 4 to 6 in. Pink. April and May.
subulata alba. 4 to 6 in. White.

PHYSOSTEGIA virginica (False-dragonhead). One of the most attractive mid-summer plants, covered with clear pink, heath-like flowers. July and Aug.

- PLATYCODON grandiflorum** (Japanese Balloon Flower). 2½ ft. Large blue, Campanula-like flowers. July to Oct.
grandiflorum album. 2½ ft. White.

PRIMULA (English Primrose). Bright canary-yellow. April and May.

- PYRETHRUM roseum** (Persian Daisy). 2 ft. One of the showiest flowers; of great value for cutting. June to July. Single. Mixed.
uliginosum (Giant Daisy). 4 ft. Large white. Aug. and Sept.

- RUDBECKIA lanceolata** (Goldenglow). 5 to 6 ft. Double yellow, Cactus-Dahlia-like flowers. July to Sept.
purpurea. 3 ft. Large, reddish purple, with dark, cone-shaped center of brown. July to Oct.

SAPONARIA Ocymoides (Soap Wort). Attractive bright rose flowers, May to August. 8 in. A fine rock plant.

- SEDUM acre** (Golden-moss). 4 in. Bright yellow, with green foliage. May to July.
album. 4 in. Green foliage, white flowers. July and Aug.
sexangulare. Dark green foliage. Yellow flower. 6 in.
sieboldii. Showy pink flowers. September to October. 8 in.
spectabile (Showy Stonecrop). 18 in. An erect growing plant with broad green foliage and large heads of handsome rose-colored flowers.

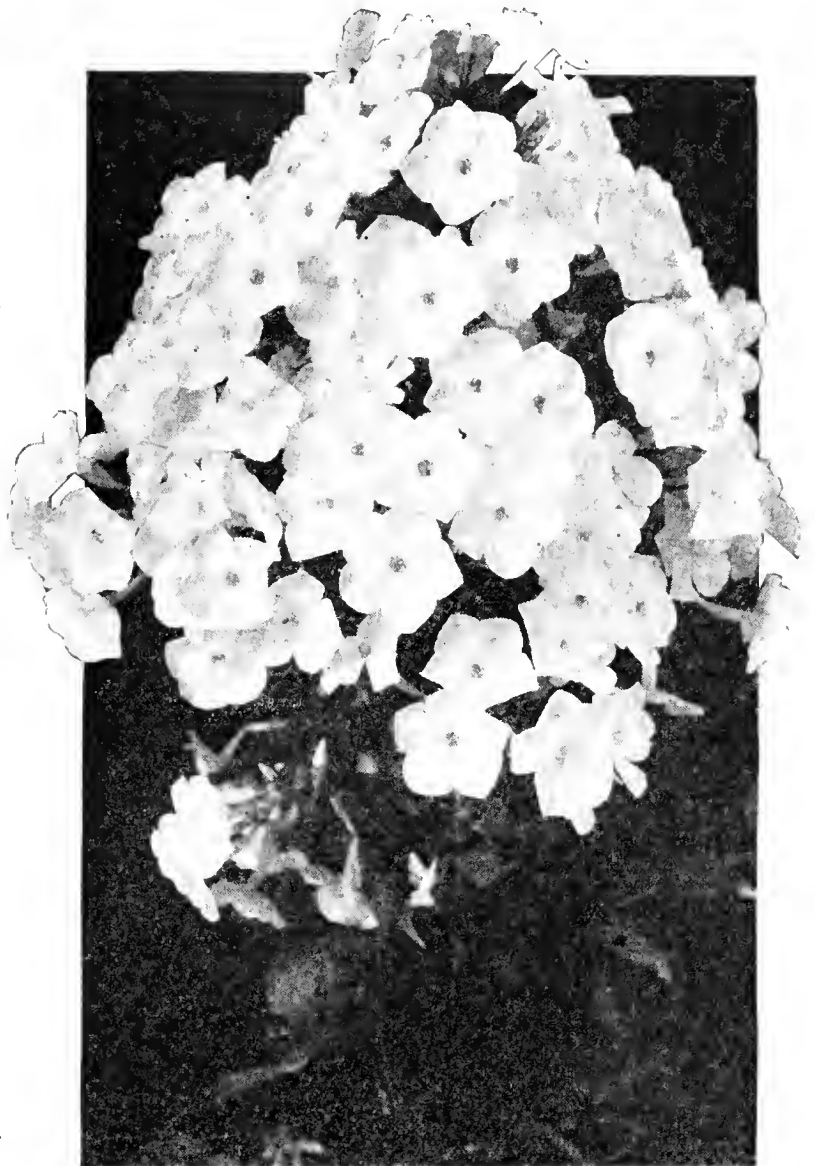

Hardy Perennial Phlox.

spectabile, Brilliant. 1 ft. Sept. and Oct. A more richly colored form of *S. spectabile*, being a bright amaranth-red.

SPIRAEA filipendula fl. pl. 2 ft. Double white. June and July.

STATICE latifolia (Sea Lavender). 1½ ft. Violet-blue. July to Sept.

STOKESIA cyanea (Cornflower Aster). 2 ft. Lavender-blue. A native plant; fine for cutting. July to Oct. alba.

TRITOMA uvaria grandiflora (Flameflower). 4 ft. Orange-scarlet. Aug. to Nov.

TROLLIUS europaeus (Globeflower). 1½ ft. Bright yellow. June to Sept. 35c.

VERONICA (Speedwell).
incana. Silvery foliage, blue flowers. July and August. 1 ft.

longifolia subsessilis. One of the handsomest blue flowering plants. 2 ft. July to Sept.

spicata. 2 ft. Blue. June to Aug.

VINCA minor (Myrtle). Creeping evergreen; good for covering ground in shady places. Bright blue flowers. April to July. \$15.00 per 100.

VIOLA, Jersey Gem. Rich violet color, fragrant; fine for borders or rockeries.

Plants on this page 25c each, \$2.50 per doz., \$18.00 per 100, except as noted. Six plants of a variety will be furnished at the dozen rate; less than six at the single rate.

Hybrid Tea (Everblooming) Roses

Two-year dormant plants, 75c each; \$7.50 per doz.; \$50.00 per 100.

Pot-Grown plants, ready about May 20th. 85c each; \$8.50 per doz.

Betty Uprichard. Semi-double, salmon-pink flowers stained with copper, pink on the outside.
Caledonia. The most desirable white. Long lasting.
Chas. P. Killham. Scarlet-orange buds opening to brilliant orange-pink, shading to yellow.
Dame Edith Helen. Enormous, very double, pure pink blooms, continually produced.
Edith Nellie Perkins. Buds of rich orange, salmon-pink on interior, turning to golden shaded blooms.
E. G. Hill. Dazzling scarlet shading to deeper red.
Etoile De France. Deep crimson with cerise-red center.
Etoile de Hollande. The world's leading red rose with brilliant blooms of magnificent size.
Feu. Jos. Looymans. Long pointed buds of vivid orange-buff; full blooms of brilliant apricot and yellow.
Gruss an Teplitz. Profuse, fragrant blooms of dark velvety scarlet.
Jonkheer J. L. Mock. Outside of petals carmine, inside flesh pink.
Joanna Hill. Light yellow, with bronze shadings in center.
Kaiserine Augusta Victoria. Cream shaded lemon.
Killarney Pink. Flesh, shaded white, suffused pale pink.
Lady Forteviot. Delightfully sweet-scented rose, saffron-yellow, flushed with carmine and orange.

Los Angeles. Of flame pink, toned coral and gold.
Miss Rowena Thom. Very large, brilliant rose-pink.
Mme. Edouard Herriot. Coral or brick-red.
Mrs. Aaron Ward. Color Indian yellow, shading to lemon.
Mrs. Chas. Bell. Shell pink.
Mrs. E. P. Thom. One of the best yellows.
Mrs. Henry Bowles. A splendid, large, fragrant flower. Pink with salmon shadings.
Mrs. Pierre Du Pont. Reddish gold buds turn to lasting and fragrant blooms of deep golden-yellow.
Mme. Butterfly. Similar to Ophelia but larger flower.
Ophelia. Salmon-flesh, shading to rose.
Olympiad. Reddish pink flowers with orange undertone.
Padre. Coppery scarlet flushed with yellow.
President Herbert Hoover. An outstanding novelty of maroon, orange and gold; a perfect rose for the home garden.
Radiance. Soft carmine-pink. Double; sweet-scented.
Red Radiance. A crimson sport of Radiance.
Souvenir De Claudius Pernet. The best and one of the few really yellow, with a pointed bud and glossy foliage.
Talisman. Most vividly colored rose, apricot shading to yellow at base, strong grower, free bloomer.
White Killarney. A pure white rose.

New Patented Roses

Pot-grown plants only. Ready for delivery about May 20th.

Aiezane. Plant patent No. 116. Large reddish brown buds, opening to sorrel with golden-yellow center, unfurling to rich apricot. \$1.50 each.
Amelia Earhart. Plant patent No. 63. Large bud, cream with blushes; flowers graduating from a deep yellow center to an outer collarette of large cream petals with a blush overtone, extremely fragrant, strong grower, free bloomer. \$1.50 each.
Better Times. Plant patent No. 23. The brilliant cerise flowers are large, double and delicately fragrant. Being produced on long strong stems, they are excellent for cutting; a very free bloomer. \$1.50 each.

Countess Vandal. Plant patent No. 38. The sensation of the shows. The most popular variety at the Century of Progress. A lovely coppery pink and gold, extra long pointed buds. \$1.00 each.
Mary Hart. H. T. Plant Patent No. 8. A striking red sport of Talisman. The bud is maroon-red, opening to well formed blossoms of deep velvety blood-red with an overglow of amber. \$1 each.
Token. Plant Patent No. 95. A single toned sun ripened apricot, a unique color. A free bloomer and has an upright growth in the garden. \$1.50 each.

Climbing Roses

Two-year dormant plants, 50c each, \$5.00 per doz., except where noted.

American Pillar. Chaste pink, white center; single.
Blaze (U. S. Plant Patent No. 10). Everblooming Paul's Scarlet Climber. A vigorous climber producing flowers of the blazing color of Paul's Scarlet and the everblooming habit of Gruss an Teplitz. \$1.25 each.
Climbing American Beauty. Rose-pink; fragrant.
Crimson Rambler. Large clusters of crimson flowers.
Dr. W. Van Fleet. Flesh pink. Double and fragrant.
Dorothy Perkins. Soft shell-pink.
Emily Gray. Long tapering, golden yellow buds. \$1.00 each.
Excelsa. Intense crimson maroon. Healthy foliage; fine.
Golden Climber (Mrs. Arthur Curtis James). Plant patent No. 28. A full semi-double yellow rose averaging four to five inches in diameter. Blooms of hybrid tea type and quality, on stems often eighteen inches or longer. \$1.50 each.
Mary Wallace. Semi-double, rose-pink, with salmon base.
Max Graf. Trailing Hybrid Rugosa Rose. Valuable as a ground cover. Foliage of the Rugosa type. Flowers single and bright pink, 60c each, \$6.00 per doz.
Paul's Scarlet Climber. Vivid scarlet, semi-double flowers of medium size, produced in large clusters.
Silver Moon. Silvery white. Foliage is mildew proof.
Tausendschon. Soft pink, turning to flesh.
The New Dawn. The everblooming Dr. W. Van Fleet. \$1.50.
White Dorothy Perkins.

Hybrid Perpetual Roses

Two-year dormant plants, 60c each; \$6.00 per doz.

Frau Karl Druschki. Pure white; large and free flowering.
General Jacqueminot. Brilliant crimson; fragrant.
George Arends. The pink Druschki. Soft pink.
J. B. Clark. Red.
Magna Charta. A bright, clear pink.
Mrs. John Laing. A constant blooming rose. Shell-pink.
Paul Neyron. A deep rose color; large.
Prince Camille de Rohan. Deep maroon-red.
Ulrich Brunner. Bright cherry-red; fragrant.

Baby Rambler Roses

Two-year dormant plants, 60c each; \$6.50 per doz.; \$50.00 per 100.

Baby Crimson Rambler. Crimson.
Elsie Poulsen. Pink flowers in clusters on long stems.
Golden Salmon. Large orange flowers in huge trusses.
Gloria Mundi. Very double flowers of rich orange-scarlet.
Triomphe Orleanais. A very fine crimson.

Miscellaneous Hardy Roses

Rosa rugosa rubra. Red. 60c each, \$6.00 per doz.
Rosa rugosa alba. White. 75c each, \$7.50 per doz.
F. J. Grootendorst. A strong, shrubby grower. The flowers are produced in large clusters like the Crimson Baby Rambler. 2-year plants, 60c each, \$6.00 per doz.
Rosa Hugonis (Golden Rose of China). Early. 60c each.
Rosa Wichuraiana (Memorial Rose). Single, white. 50c each.

Deciduous Shrubs

Ornamental shrubs occupy an important place in the home garden. They present a variety of color, season of bloom and type of growth, as well as producing brilliant colored foliage in the fall and bright colored berries in the winter.

ALMOND (*Amygdalus*). Produces double, rose colored flowers in great profusion in early spring. 2 to 3 ft. 60c each; 3 to 4 ft. 75c each.

ALTHEA (*Hibiscus syriacus*). **Rose-of-Sharon**. Tall growing, late flowering shrubs of unusual beauty. Pink, purple, red and white. Bush form. 2 to 3 ft., 40c each; 3 to 4 ft. 50c each; tree form, 75c each.

ARALIA (*Acanthopanax pentaphyllum*). A graceful shrub with spiny branches and bright green foliage. 2 to 3 ft., 35c each; 3 to 4 ft., 40c each.

AZALEA arborescens (Sweet Azalea). Fragrant white flowers in June. 1 to 1½ ft., \$2.25; 1½ to 2 ft., \$3.00 each.

kaempferi (Torch Azalea). Orange-red. 15 to 18 in., \$2.00 each; 18 to 24 in., \$2.50 each; 2 to 2½ ft., \$3.25.

calendulacea (Flame Azalea). Flame-red flowers late in May. 1 to 1½ ft., \$1.50 each; 1½ to 2 ft., \$2.00 each.

mollis (Chinese Azalea). Mixed colors. 12 to 15 in., \$1.75 each; 18 to 24 in., \$2.75 each.

nudiflora (Pinxterflower). Deep pink to reddish purple. 1 to 1½ ft., \$1.75 each; 1½ to 2 ft., \$2.25 each.

poukhanensis (Korean Azalea). Low growing; pale lilac purple. 15 to 18 in., \$2.00 each; 1½ to 2 ft., \$2.75 each;

viscosa (Swamp Azalea). Fragrant white flowers in July; prefers damp soil. 2 to 2½ ft., \$2.00 each.

BARBERRY, Japanese. See Hedge Plants, page 80.

Redleaf Japanese (*Berberis thunbergii atropurpurea*). 15 to 18 in., 40c each.

BERBERIS THUNBERGII PLURIFLORA ERECTA.

(U. S. Plant Patent No. 110). (True Hedge Columnberry). This new barberry is pyramidal in habit, with foliage of a dense deep shade of green. It is easily trained into perfect spheres and pyramids and makes a beautiful hedge, requiring very little trimming. 12 to 15 in., 40c each; \$4.00 per doz.; \$25.00 per 100. 15 to 18 in., 50c each; \$5.00 per doz.; \$32.50 per 100. 18 to 24 in., 60c each; \$6.00 per doz.; \$40.00 per 100.

BUDDLEIA, **He de France**. Splendid new form of the useful Summer Lilac or Buddleia. Its long heavy sprays are densely covered with small violet purple flowers, each illuminated by a brilliant golden eye. 50c each.

CORALBERRY (*Symphoricarpos vulgaris*). Clusters of coral-red berries last throughout the winter. 2 to 3 ft., 35c each; 3 to 4 ft., 50c each.

COTONEASTER divaricata (Spreading Cotoneaster). A spreading variety with arching branches. Pink flowers are produced in June and bright red fruit in September. 18 to 24 in., 75c; \$7.50 per doz.

horizontalis (Rock Cotoneaster). A low shrub with horizontal branches and small glossy green leaves. The flowers are pinkish white and the fruit is bright red. A desirable variety for planting in the rock garden. 5 in. pots, 6 to 9 in., 60c each; 6 in. pots, 15 to 18 in., \$1.00 each.

DAPHNE mezereum (February Daphne). A small hardy shrub blooming long before the leaves appear. The stems are closely set with deep red, fragrant flowers. Enjoys partial shade. 15 to 18 in., 75c.

DEUTZIA gracilis. Dwarf; white flowers cover the entire plant in May. 1 to 1½ ft. 40c each.

lemoinei. Medium growth. White flowers on erect stems in June. 2 to 2½ ft., 40c each.

Pride of Rochester. Tall; double white flower tinged with pink; in late June. 2 to 3 ft., 40c each; 3 to 4 ft., 50c each.

DOGWOOD (*Cornus*). Strong growing shrubs, attractive for their bloom, berries, leaf coloring and colored bark.

Cornus alba. Flowers white, fruit blue, branches red 3 to 4 ft., 40c each; 4 to 5 ft., 50c each.

Cornus elegantissima. Green foliage, edged with white; branches red. 3 to 4 ft., 75c each.

Cornus stolonifera flaviramea. Flowers white, branches yellow. 3 to 4 ft., 50c each.

EUONYMUS alatus (Winged Burningbush). A handsome shrub of medium growth. Peculiar winged branches; foliage light green changing to bright crimson in autumn. 2 to 3 ft., 50c each; 3 to 4 ft., 75c each; 4 to 5 ft., \$1.00 each.

a. compacta (Dwarf Winged Euonymus). A choice dwarf, compact shrub which is unquestionably one of the best deciduous shrubs for growing in the shade. For a low, wide hedge this variety has no equal. 12 to 18 in., 40c each; \$4.25 per doz.; \$30.00 per 100. 18 to 24 in., 50c each; \$5.50 per doz.; \$42.00 per 100.

FORSYTHIA (Golden Bell). First of the spring flowering shrubs. Rich green foliage; tall and graceful in habit. **fortunei**. Upright growth. 3 to 4 ft., 40c each; 4 to 5 ft., 50c each.

intermedia. Medium growth. 2 to 3 ft., 40c each; 3 to 4 ft., 50c each.

suspensa. Weeping in habit. 2 to 3 ft., 35c each; 3 to 4 ft., 50c each.

FRINGE TREE (*Chionanthus virginica*). A large growing shrub with heavy foliage and lacy white flowers. 2 to 3 ft., \$1.00 each; 3 to 4 ft., \$1.50 each.

HONEYSUCKLE (*Lonicera*). Tall, bushy, hardy shrubs.

Morrow Honeysuckle (*L. morrowi*). Medium height, drooping branches, white flowers, red fruit. 2 to 3 ft., 40c each; 3 to 4 ft., 50c each.

Tatarian Honeysuckle (*L. tatarica*). Tall, pink flowers, crimson fruit. 2 to 3 ft., 40c each; 3 to 4 ft., 50c each.

White Tatarian Honeysuckle (*L. tatarica alba*). Tall, white flowers, crimson fruit. 3 to 4 ft., 50c each.

HYDRANGEA arborescens grandiflora (Hills of Snow). Large clusters of white flowers in midsummer. 18 to 24 in., 35c each; 2 to 3 ft., 45c each.

paniculata grandiflora. The old-fashioned, common variety with large heads of white flowers in late summer which turn a bright pink in fall. 2 to 3 ft., 35c each; 3 to 4 ft., 50c each; 4 to 5 ft., 75c each.

Standard or Tree Hydrangea. 4 to 6 ft., \$1.00 each.

JETBEAD (*Rhodotypos kerrioides*). Medium height; single, white flowers followed by shiny, black fruit which last throughout the winter. 2 to 3 ft., 40c each; 3 to 4 ft., 50c each.

KOLKWTZIA amabilis (Beautybush). A free growing shrub with tubular pink flowers produced abundantly in rounded clusters the whole length of the branches. 18 to 24 in., 50c each; 2 to 3 ft., 60c each.

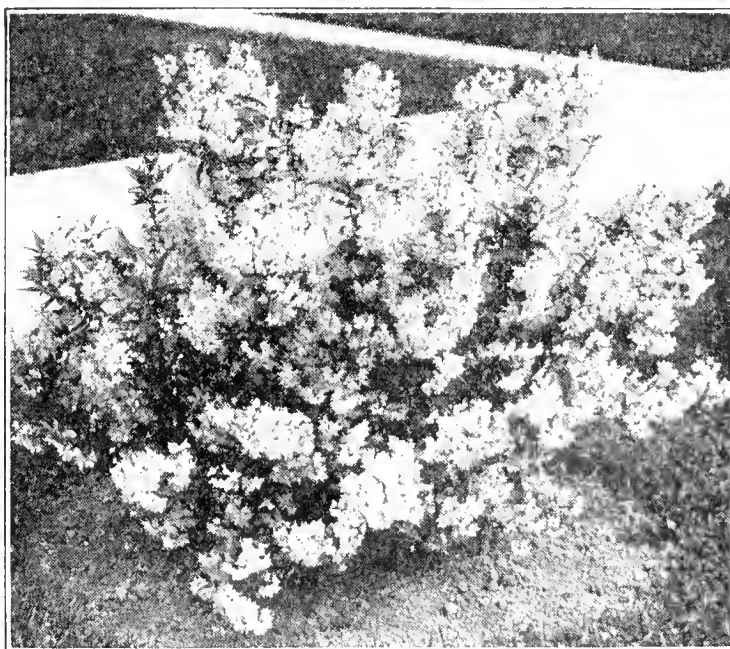

Deutzia gracilis.

Deciduous Shrubs—Continued

LILAC (Syringa). Old-fashioned favorites familiar to all.
Common Purple. 2 to 3 ft., 40c each; 3 to 4 ft., 60c each.
Common White. 1½ to 2 ft., 40c each; 2 to 3 ft., 60c each; 3 to 4 ft., 75c each.

Persian Lilac. Very fragrant, pale purple flowers in loose panicles. 2 to 3 ft., 50c each.

Villosa Lilac. Heavy bright green foliage, flowers rosy white and fragrant; late blooming. 3 to 4 ft. 50c each; 4 to 5 ft., 75c each.

HYBRID LILACS. Unlike the old varieties, this type bloom when very young and their double and single blooms are produced in a wide range of color. The varieties listed are priced as follows: 1½ to 2 ft., 45c each; 2 to 3 ft., 60c each; 3 to 4 ft., 75c each; 4 to 5 ft., \$1.25 each.

Single Varieties:

Amelia Dupret. Pale lilac.

Chas. X. Reddish purple.

Congo. Dark crimson.

Marie Legraye. White.

Rubra de Marly. Purple.

Souv. de Ludwig Spaeth. Red.

Double Varieties:

Alphonse Lavallee. Light blue.

Belle de Nancy. Satin pink.

Doyonne Keteleer. Light pink.

Marlyensis Pallida. Reddish purple.

Mme. Lemoine. White.

Ville de Troyes. Dark purple.

PEPPERBUSH (Clethra alnifolia). Medium growth, white fragrant flowers in midsummer. 18 to 24 in. 50c each.

PRIVET (Ligustrum). Hedge varieties, see page 80.

Regel Privet (L. regelianum). Low-spreading shrub of graceful habit. A fine border shrub. 1½ to 2 ft., 40c each, \$4.00 per doz.

JAPANESE QUINCE (Cydonia japonica). Dark green, glossy foliage; scarlet flowers in May. 1½ to 2 ft., 40c each. 2 to 3 ft., 50c each.

FLOWERING RASPBERRY (Rubus odoratus).

A shade-growing plant of medium height; flowers rosy purple. 50c each.

SIBERIAN PEA-TREE (Caragana arborescens).

A hardy, tall growing shrub with dark green wood, light green foliage and small, pea-shaped flowers in June. 2 to 3 ft., 50c each; 3 to 4 ft., 60c each.

SMOKE BUSH (Rhus cotinus). Much admired for its clusters of purplish, misty flowers in June. 2 to 3 ft., 75c each; 3 to 4 ft., \$1.00 each.

SPIREA (Spiraea). An interesting family of flowering shrubs, covering a wide season of bloom. Very hardy.

Anthony Waterer. Dwarf; rose-pink blooms in July and Aug. 1½ to 2 ft., 35c each.

bumalda. A light pink variety of the above. 18 to 24 in., 40c each.

froebell. A stronger grower than Anthony Waterer; rose-pink blooms in July and Aug. 1½ to 2 ft., 35c each; 2 to 3 ft., 45c each.

prunifolia. The true Bridalwreath. Tiny white flowers in great masses along the stems are produced late in May. 2 to 3 ft., 45c each; 3 to 4 ft., 55c each.

thunbergi. Medium growth; small white flowers in early May; graceful habit. 2 to 3 ft., 45c each.

trichocarpa (Korean Spiraea). A newer variety much like *S. vanhouttei*, but blooming about two weeks later. 2 to 3 ft., 40c each; 3 to 4 ft., 50c each.

Vanhouttei. The finest of all Spireas. Graceful arching branches are completely covered with white flowers in June. 2 to 3 ft., 35c each; 3 to 4 ft., 50c each; 4 to 5 ft., 75c each.

STEPHANANDRA flexuosa. Spreading and drooping in habit; foliage finely cut and lacy; flowers white. 2 to 3 ft., 50c each.

SNOWBERRY (Symphoricarpos racemosus). A bushy shrub with slender branches which droop gracefully; white waxy berries cover the plant in fall. 2 to 3 ft., 35c each; 3 to 4 ft., 50c each.

SYRINGA.

Common Syringa (Philadelphus coronarius). Tall, pure white, fragrant flowers in June. 3 to 4 ft., 40c each; 4 to 5 ft., 50c each.

Golden Syringa (Philadelphus coronarius aurea). A dwarf variety with bright yellow foliage. 1 to 1½ ft., 50c each; 1½ to 2 ft., 60c each.

Large-Flowered Syringa (Philadelphus grandiflorus). A vigorous growing variety; white flowers. 3 to 4 ft., 40c each; 4 to 5 ft., 50c each.

Virginal. Very large semi-double, white flowers, blooming throughout the summer. 2 to 3 ft., 50c each; 3 to 4 ft., 60c each.

VIBURNUM.

Dwarf Viburnum (V. opulus nana). a dense, compact, dwarf plant useful for very low borders. 8 to 10 in., 30c each; 10 to 12 in., 40c each.

European High Bush Cranberry (V. opulus). A tall growing shrub producing large clusters of scarlet fruit late in the summer. 2 to 3 ft., 45c each; 3 to 4 ft., 50c each.

Common Snowball (V. opulus sterile). An old favorite. 1½ to 2 ft., 50c each; 2 to 3 ft., 60c each.

Japan Snowball (V. plicatum). A compact grower with heavy foliage. Round white flowers in May. 2 to 3 ft., 75c each.

Single Japan Snowball (V. tomentosum). 1½ to 2 ft., 50c each. 2 to 3 ft., 60c each.

May-flowering Viburnum (V. carlesii). Compact and bushy in growth; fragrant, pink flowers in May. A choice variety. 18 to 24 in., 75c each; 2 to 2½ ft., \$1.00 each; 2½ to 3 ft., \$1.25 each; 3 to 4 ft., \$1.50 each.

WEIGELA. These valuable shrubs produce trumpet-shaped flowers in great profusion during May and June.

candida. White. 2 to 3 ft., 60c each.

Eva Rathke. Dark reddish green foliage; dark red blossoms throughout summer. 2 to 3 ft., 50c each.

rosea. A tall growing variety, producing pink flowers in June. 2 to 3 ft., 50c each; 3 to 4 ft., 75c each.

Variegated. A dwarfish type with white margined leaves; flowers white. 1½ to 2 ft., 50c each; 2 to 3 ft., 75c each.

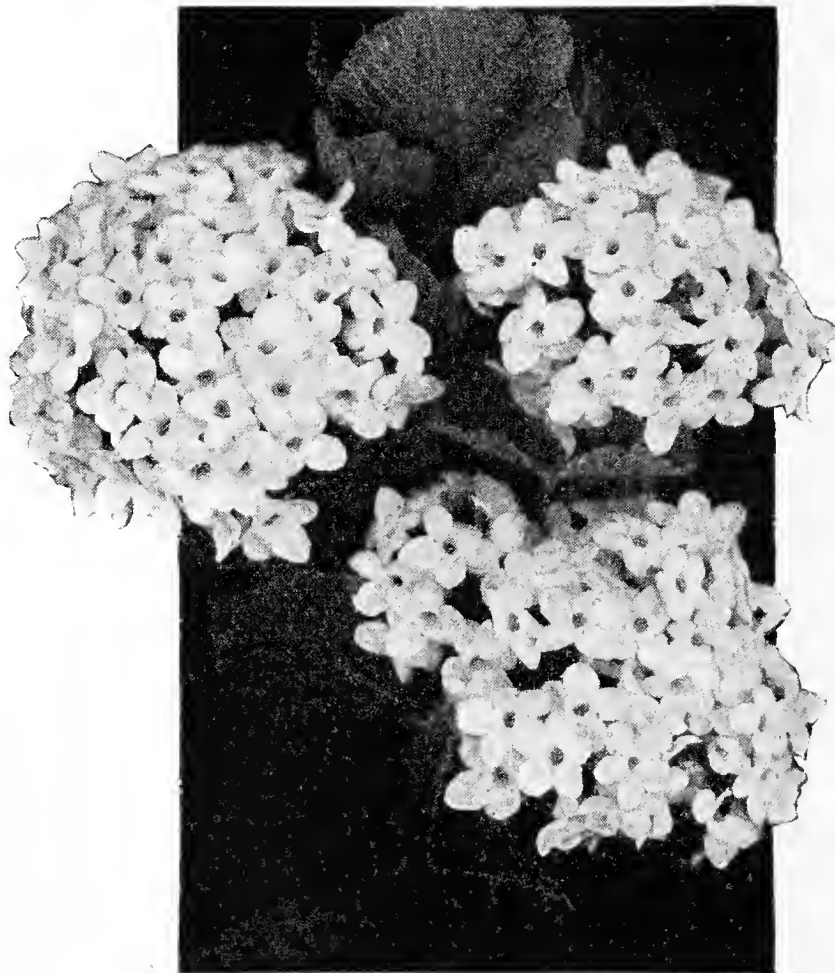

Viburnum Carlesii.

Deciduous Trees

Ash - Fraxinus

American White (*F. americana*). A large, broad-headed tree suitable for lawn or street planting. 10 to 12 ft., \$2.00 each.

Beech - Fagus

European Beech (*F. sylvatica*). Light green foliage; compact in habit. 2 to 3 ft., \$1.50 each; 3 to 4 ft., \$2.50 each; 4 to 5 ft., \$3.50 each.

Purple Beech (*F. sylvatica purpurea*). Rich purplish foliage. A desirable lawn tree. 1½ to 2 ft., \$2.50 each; 2 to 3 ft., \$3.50 each; 3 to 4 ft., \$6.00 each.

Birch - Betula

European White Birch (*B. alba*). 6 to 8 ft., \$1.50 each.
Cutleaved Weeping Birch (*B. alba laciniata*). 5 to 6 ft., \$2.00 each; 6 to 8 ft., \$2.50 each; 8 to 10 ft., \$3.00 each.
Canoe Birch (*B. papyrifera*). 6 to 8 ft., \$1.75 each.

Catalpa

Umbrella Catalpa (*C. bungei*). Dense, globe-shaped heads on slender stems. 1 yr. heads, \$2.00; 2-yr. heads, \$2.50.

Flowering Crab - Malus

The Flowering Crabs are slow growing trees with fragrant blossoms from pure white to deep red. Ideal trees for garden border or single specimens.

The following varieties, 2 to 3 ft., 75c each;
 3 to 4 ft., \$1.00 each; 4 to 5 ft., \$1.25 each;
 5 to 6 ft., \$2.00 each; 6 to 7 ft., \$2.50 each.

Bechtels Crab (*M. loensis plena*). Double pink in clusters.
Carmin Crab (*M. atrosanguinea*). Brilliant carmine.
Japanese Crab (*M. floribunda*). Pinkish buds, white flowers.
Parkman Crab (*M. halliana parkmani*). Double rose-red.
Redvein Crab (*M. niedzwetzkyana*). Early flowering red.

Dogwood - Cornus

Redflowering Dogwood (*C. florida rubra*). 3 to 4 ft. \$2.00 each; 4 to 5 ft., \$2.75 each; 5 to 6 ft. \$4.00 each; 6 to 7 ft., \$6.00 each.
Whiteflowering Dogwood (*C. florida*). 3 to 4 ft., \$1.00 each; 4 to 5 ft., \$1.50 each; 5 to 6 ft., \$2.50 each; 6 to 8 ft., \$3.50 each; 8 to 10 ft., \$5.00 each.

Elm - Ulmus

American Elm (*U. americana*). 6 to 8 ft., \$1.25 each; 8 to 10 ft., \$1.75 each; 10 to 12 ft., \$2.00 each.
Chinese Elm (*U. pumilla*). 5 to 6 ft., \$1.00 each; 6 to 8 ft., \$1.50 each; 8 to 10 ft., \$2.00 each; 10 to 12 ft., \$2.50 each.
Moline Elm (*U. americana moline*). A large, fast growing tree with handsome foliage. 6 to 8 ft., \$1.50 each; 8 to 10 ft., \$2.50 each; 10 to 12 ft., \$3.50 each.

Hawthorn - Crataegus

Scarlet Hawthorn (*C. oxyacantha paull*). 3 to 4 ft., \$1.50 each; 4 to 5 ft., \$1.75 each; 5 to 6 ft., \$2.00 each.
White Hawthorn (*C. oxyacantha alba*). 3 to 4 ft., \$1.50 each; 4 to 5 ft., \$1.75 each; 5 to 6 ft., \$2.00 each.

Judas-Tree - Cercis

Redbud or Judas-tree (*C. canadensis*). 4 to 5 ft., \$1.50 each; 5 to 6 ft., \$2.00 each.

Linden - Tilia

American Linden (*T. platyphyllos*). 6 to 8 ft., \$2.00 each.
European Linden (*T. vulgaris*). 6 to 8 ft., \$2.50 each; 8 to 10 ft., \$3.00 each.

Maidenhair-Tree - Ginkgo

Maidenhair-tree (*G. biloba*). Fan-shaped foliage, resembling the Maidenhair Fern. Very ornamental. 6 to 8 ft., \$3.50 each; 8 to 10 ft., \$4.50.

Magnolia

Soulangiana (*Saucer Magnolia*). 2 to 3 ft., \$4.00 each; 3 to 4 ft., \$5.75 each; 4 to 5 ft., \$8.00 each.
Stellata. 18 to 24 in., \$3.50 each; 2 to 2½ ft., \$4.50 each.

Maple - Acer

Norway Maple (*A. platanoides*). 6 to 8 ft., \$1.50 each; 8 to 10 ft., \$2.00 each; 10 to 12 ft., \$3.00 each; 12 to 14 ft., \$4.00 each.

Rock Maple (*A. saccharum*). 8 to 10 ft., \$2.50 each; 10 to 12 ft., \$3.50 each; 12 to 14 ft., \$4.50; 14 to 16 ft., \$5.50.

Schwedleri Maple (*A. schwedleri*). Purplish foliage. A very desirable lawn tree. 6 to 8 ft., \$2.00 each; 8 to 10 ft., \$3.00 each; 10 to 12 ft., \$4.50 each.

Silver Maple (*A. dasycarpum*). A rapid growing tree for lawn or street planting. 6 to 8 ft., \$1.50 each; 8 to 10 ft., \$1.00 each; 10 to 12 ft., \$2.50 each.

Wier's Cutleaved Weeping Maple (*A. dasycarpum wieri*). A graceful, drooping tree of rapid growth; ideal as a lawn specimen. 6 to 8 ft., \$1.00 each; 8 to 10 ft., \$1.50 each; 10 to 12 ft., \$2.50 each; 12 to 14 ft., \$3.00 each.

Bloodleaved Japan Maple (*A. palmatum atropurpureum*). Very dwarf; deep blood red foliage. 15 to 18 in., \$2.00 each; 18 to 24 in., \$2.50 each; 2 to 2½ ft., \$4.00 each.

Mountain-Ash (Sorbus)

European Mountain-Ash (*S. aucuparia*). White flowers in May; clusters of orange-red berries in autumn; medium growth. 6 to 8 ft., \$1.50 each; 8 to 10 ft., \$2.00 each; 10 to 12 ft., \$3.00 each.

Mulberry (Morus)

Teas' Weeping Mulberry (*M. tatarica pendula*). A dwarf weeping tree with long, pendulous branches which droop to the ground. \$2.50 each.

Oak - Quercus

Pin Oak (*Q. palustris*). Pyramidal habit, deeply cut leaves. 6 to 8 ft., \$3.00 each; 8 to 10 ft., \$4.00 each; 10 to 12 ft., \$5.00 each.
Red Oak (*Q. rubra*). 6 to 8 ft., \$3.00 each.



Lombardy Poplar.

Poplar - Populus

Carolina Poplar (*P. deltoides*). Tall and spreading, rapid growth. 6 to 8 ft., 75c each; 8 to 10 ft., \$1.00 each; 10 to 12 ft., \$1.50 each.
Lombardy Poplar (*P. nigra italica*). A tree of rapid growth, useful for screening. The trees which we offer are bushy and the branches start from the ground. 6 to 8 ft., 60c each, \$6.00 per doz.; 8 to 10 ft., 75c each, \$8.50 per doz.; 10 to 12 ft., \$1.00 each, \$11.00 per doz.; 12 to 14 ft., \$1.50 each, \$15.00 per doz.

Willow - Salix

Golden Bark Willow (*S. vitellina aurea*). 5 to 6 ft., 75c each; 6 to 8 ft., \$1.00 each; 8 to 10 ft., \$1.25 each.
Laurel-leaved Willow (*S. pentandra*). 4 to 5 ft., 75c each; 5 to 6 ft., \$1.00 each; 6 to 8 ft., \$1.25 each.
Thurlow's Willow (*S. elegantissima*). 6 to 8 ft., \$1.25 each; 8 to 10 ft., \$1.75 each; 10 to 12 ft., \$2.00 each.
Wisconsin Weeping Willow (*S. bianda*). 6 to 8 ft., \$1.00 each; 8 to 10 ft., \$1.50 each.

Hardy Climbing Plants and Flowering Vines

ACTINIDIA arguta , Oval, glossy leaves and clusters of fragrant flowers	Each	Doz.
	\$0.75	\$ 7.50
AKEBIA quinata , Clover-like leaves and fragrant, velvety purple flowers75	7.50
AMPELOPSIS quinquefolia (Virginia Creeper). Rapid grower50	5.00
engelmanni , A creeper that clings to stone or wood as tightly as English Ivy50	5.00
veitchi (Japanese or Boston Ivy). Very fine for covering walls, rocks, etc.50	5.50
Pot-grown, ready May 15	1.00	11.00
ARISTOLOCHIA siphon (Dutchmans-pipe). Heart-shaped leaves; the brown flowers resemble a pipe	1.00	10.00
BIGNONIA radicans (Trumpetflower). Large trumpet-shaped, orange and red flowers ..	.60	6.00
CELASTRUS orbiculatus (Japanese Bittersweet). A strong climbing shrub with glossy green foliage, and in autumn covered with bright yellow fruit50	5.00
scandens (Roxbury Waxwork). Glossy leaves and clusters of orange-crimson fruit, which remains on all winter50	5.00
CLEMATIS paniculata , Glossy, dark green foliage, and covered in the latter part of the summer with star-like white flowers, fragrant35	3.75
Extra large50	5.50
Pot-grown, ready May 1575	8.25
henryi , One of the best whites; very large white flowers often as much as 8 inches across. A continuous bloomer	1.00	10.00
jackmani , Large violet-purple; free bloomer ..	1.00	10.00
Mme. Edouard Andre , Large carmine-red flowers; very free bloomer	1.00	10.00
ENGLISH IVY (<i>Hedera helix</i>). A very desirable evergreen climber, succeeds best in a sheltered, shady situation50	5.00
LYCIVIA chinense (Matrimony-vine). Old favorites, shrubby climbers, fine for porches and trellises. Very fragrant.		
Hall's Japan , Fragrant, yellow and cream-colored flowers all summer40	4.50
Pot-grown, ready May 1575	8.25
Scarlet Trumpet , Clusters of tubular scarlet flowers all summer50	5.50
HOP VINE , Vigorous and quick growing twiner, for covering arbors, etc.50	5.00



Hall's Japan Honeysuckle.

	Each	Doz.
LYCIVIA chinense (Matrimony-vine). A climbing shrub with light green foliage and pale purple flowers; fine for northern exposures	\$0.50	\$ 5.00
POLYGONUM auberti (Silver Lace Vine). A very strong growing, decorative climbing plant, staying in bloom through the summer and autumn. The flowers are in large sprays of pure white75	7.50
WISTERIA sinensis (Chinese Wisteria). Long, pendulous clusters of pale blue75	7.50
sinensis alba , White-flowered75	7.50

Hedge Plants

BARBERRY thunbergii or Japanese.	Doz.	100
12 to 15 in.	\$1.25	\$ 7.00
15 to 18 in.	1.75	10.00
18 to 24 in.	2.00	15.00
24 to 30 in.	3.00	24.00
PRIVET, Amur River.		
18 to 24 in.	1.50	8.00
24 to 36 in.	2.00	12.00
36 to 48 in.	2.50	15.00
California.		
18 to 24 in.75	4.00
24 to 36 in.	1.00	6.00
36 to 48 in.	1.75	8.00
Ibota.		
18 to 24 in.	1.50	8.00
24 to 36 in.	2.00	10.00
36 to 48 in.	3.00	15.00

Ibodium , A cross between Ibota and California Privet. It has the attractive dark green leaves of the California, but is of a more branching habit, making a more compact hedge in less time. The best of all Privets.	Doz.	100
18 to 24 in.	\$1.00	\$ 7.00
24 to 36 in.	1.50	10.00
36 to 48 in.	2.00	12.00
LILAC, Common. Purple. 2 to 3 ft.	4.00	25.00
White. 18 to 24 in.	4.00	25.00
White. 2 to 3 ft.	6.00	40.00
SPIREA vanhouttei.		
2 to 3 ft.	3.50	25.00
ARBOR-VITAE, American.		
2 to 3 ft.	10.00	75.00
HEMLOCK.		
1½ to 2 ft.	11.00	80.00
SPRUCE, Norway.		
2 to 3 ft.	9.50	65.00

Evergreen Trees

Arborvitae - Thuja

American Arborvitae (*T. occidentalis*). The common upright variety used as single specimens and for hedges. 2 to 3 ft., 90c each; 3 to 4 ft., \$1.50 each; 4 to 5 ft., \$1.75 each; 5 to 6 ft., \$3.00 each; 6 to 7 ft., \$4.00 each; 7 to 8 ft., \$6.50 each; 8 to 9 ft., \$8.00 each; 9 to 10 ft., \$10.00 each.

Dark American Arborvitae (*T. occidentalis nigra*). A newer variety with foliage much darker than the American and hardier. 2 to 3 ft., \$1.75 each; 3 to 3½ ft., \$2.25 each; 3½ to 4 ft., \$3.00; 4 to 5 ft., \$5.00 each; 5 to 6 ft., \$6.00 each.

George Peabody Arborvitae (*T. occidentalis lutea*). Similar to the American in habit; foliage golden yellow. 3 to 4 ft., \$2.50 each; 4 to 5 ft., \$3.00 each.

Globe Arborvitae (*T. occidentalis globosa*). Round, compact form with dense foliage; dwarf. 12 to 15 in., 75c each; 15 to 18 in., \$1.00 each; 18 to 24 in., \$1.25 each; 2 to 2½ ft., \$1.75 each.

Little Gem Arborvitae (*T. occ. Little Gem*). One of the few Arbor-Vitae which is a true dwarf. The foliage is dark green. An ideal dwarf evergreen for the rock garden. 6 to 8 in., \$1.00.

Pyramidal Arborvitae (*T. occidentalis pyramidalis*). A most valuable upright evergreen of dense, compact habit. Foliage dark green. 2 to 3 ft., \$1.25; 3 to 4 ft., \$1.50; 4 to 5 ft., \$2.50; 5 to 6 ft., \$3.25; 6 to 7 ft., \$4.50; 7 to 8 ft., \$7.00.

Rosenthal Arborvitae (*T. occidentalis Rosenthalii*). One of the best of the pyramidal type. It makes a compact, broad, symmetrical pyramid and is very useful for formal plantings and specimens. The foliage, which is a lustrous, dark green, retains its color throughout the entire winter. 2 to 2½ ft., \$3.00 each; 2½ to 3 ft., \$3.50 each; 3 to 3½ ft., \$4.00 each; 3½ to 4 ft., \$4.50 each; 4 to 5 ft., \$5.00 each; 5 to 6 ft., \$6.50 each.

Siberian Arborvitae (*T. occidentalis wareana*). A very hardy variety holding its dark green color throughout the entire year; low and bushy in habit. 18 to 24 in., \$1.25 each; 2 to 2½ ft., \$2.00 each; 2½ to 3 ft., \$3.00 each.

Vervaeke Arborvitae (*T. occidentalis vervaekiana*). The foliage shows a little golden tinge; densely branched and of columnar habit. 1½ to 2 ft., \$1.00 each; 2 to 3 ft., \$1.50 each; 3 to 4 ft., \$2.50 each; 4 to 5 ft., \$3.50 each; 5 to 6 ft., \$5.00 each.

Fir - Abies

Fraser Fir (*A. fraseri*). A compact pyramidal grower. The foliage, which is fragrant, is a lustrous, dark green and is a bluish-white beneath. Resembles closely the Balsam fir. 2 to 2½ ft., \$2.00 each; 2½ to 3 ft., \$3.00 each; 3 to 4 ft., \$4.00 each; 4 to 5 ft., \$5.00 each.

Nikko Fir (*A. homolepis*) (*Brachyphylla*). This is a tall growing tree from the mountains of central Japan. The dark green leaves are silvery white beneath. A handsome lawn tree. 2 to 2½ ft., \$2.00 each; 2½ to 3 ft., \$2.50 each; 3 to 4 ft., \$3.00 each; 4 to 5 ft., \$4.00 each.



Pfitzer Juniper.

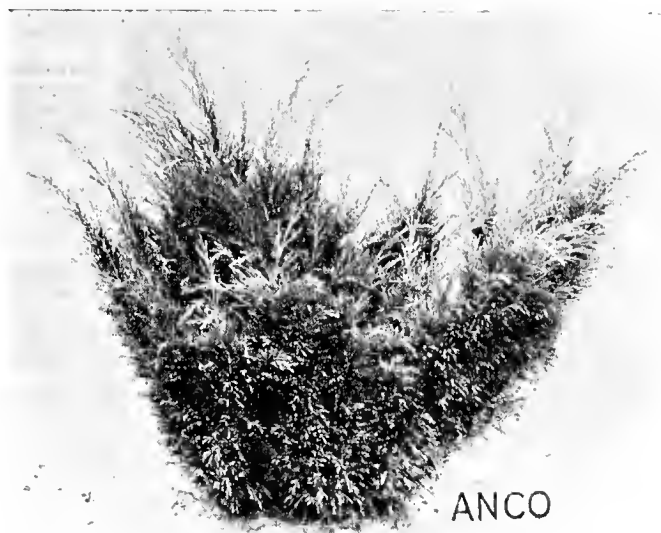

Savin Juniper.

Veitch Fir (*A. veitchii*). The most rapid growing of all the Firs. Symmetrical in shape with dark green foliage, silvered on the under side. 2 to 2½ ft., \$2.50 each; 2½ to 3 ft., \$3.50 each; 3 to 4 ft., \$4.00 each; 4 to 5 ft., \$5.00.

White Fir (*A. concolor*). A rapid growing tree of majestic proportions when mature. The color varies from a light green to almost blue. One of our finest specimen lawn trees. 2 to 2½ ft., \$2.50 each; 2½ to 3 ft., \$3.25 each; 3 to 4 ft., \$4.00 each; 4 to 5 ft., \$5.00 each.

Douglas Fir (*Pseudotsuga douglasii*). Large, very rapid growing tree forming a dense pyramid. The foliage is a soft bluish green. 2 to 3 ft., \$2.00 each; 3 to 4 ft., \$2.50 each; 4 to 5 ft., \$3.00 each; 5 to 6 ft., \$4.00 each.

Hemlock - Tsuga

Canadian Hemlock (*T. canadensis*). A medium sized tree of dense growth with rich green foliage; branches droop gracefully. 18 to 24 in., \$1.00 each; 2 to 2½ ft., \$1.60 each; 2½ to 3 ft., \$2.00 each; 3 to 4 ft., \$2.50 each; 4 to 5 ft., \$3.50 each; 5 to 6 ft., \$5.00 each; 6 to 7 ft., \$7.50 each; 7 to 8 ft., \$10.00 each.

Juniper - Juniperus

Chinese Juniper (*J. chinensis*). Pyramidal in outline, with silvery green foliage. 2 to 2½ ft., \$2.50 each; 2½ to 3 ft., \$3.00 each; 3 to 4 ft., \$4.50 each.

Greek Juniper (*J. excelsa stricta*). A very symmetrical dwarf evergreen of conical shape; bluish green. 12 to 18 in., \$1.50 each; 18 to 24 in., \$2.25 each; 2 to 2½ ft., \$3.00 each.

Irish Juniper (*J. communis hibernica*). Slender and columnar in habit with bluish green foliage. 1½ to 2 ft., \$1.00 each; 2 to 3 ft., \$1.50 each; 3 to 3½ ft., \$2.00 each; 3½ to 4 ft., \$2.50 each.

Pfitzer Juniper (*J. chinensis pfitzeriana*). A most valuable foundation evergreen. Dwarf in habit, its bluish green foliage is carried on graceful spreading branches; thrives under very unfavorable conditions. 18 to 24 in. spread, \$1.65 each; 2 to 2½ ft., \$2.00 each; 2½ to 3 ft., \$3.00 each.

Red Cedar (*J. virginiana*). A native Cedar of pyramidal shape with foliage varying from bright green in summer to a bronzy hue in winter. Useful for formal effect. 6 to 7 ft., \$5.00 each; 7 to 8 ft., \$6.50; 8 to 9 ft., \$9.00 each.

Savin Juniper (*J. sabina*). Beautiful dark green foliage, with fan-shaped branches. Very hardy. 15 to 18 in., \$1.25 each; 18 to 24 in., \$1.50 each; 24 to 30 in., \$2.50 each; 2½ to 3 ft., \$3.25 each; 3 to 3½ ft., \$4.00 each.

Spreading Juniper (*J. communis*). A very hardy trailing type with bluish foliage; valuable for rock planting. 2 to 2½ ft., \$2.50 each.

Swedish Juniper (*J. communis suecica*). Very similar to the Irish Juniper, but much hardier. 2 to 2½ ft., \$1.50 each; 2½ to 3 ft., \$2.00 each; 3 to 4 ft., \$2.50 each; 4 to 5 ft., \$3.00 each.

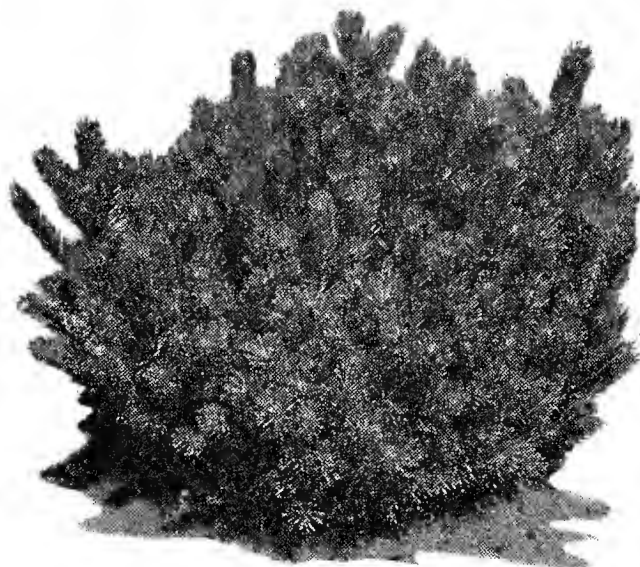

Dwarf Mugho Pine.

Pine - Pinus

Austrian Pine (*P. nigra*). A tree of rapid growth with long dark green foliage. A vigorous and rugged grower even under unfavorable conditions. 2 to 3 ft., \$2.50 each; 3 to 4 ft., \$3.50 each; 4 to 5 ft., \$4.50 each; 5 to 6 ft., \$6.00 each.

Dwarf Mugho Pine (*P. montana mughus*). Foliage dark green; very dwarf in habit; very useful as a border or rock plant. 12 to 15 in., \$1.00 each; 15 to 18 in., spread, \$1.35 each; 18 to 24 in., spread, \$1.50 each; 2 to 2½ ft., \$3.00 each; 2½ to 3 ft., \$4.00 each.

Red Pine (*P. resinosa*). A vigorous grower with long, rich green needles. 2 to 3 ft., \$1.00 each; 3 to 4 ft., \$2.00 each; 4 to 5 ft., \$3.00 each; 5 to 6 ft., \$4.50 each.

Scotch Pine (*P. sylvestris*). A tree of rapid growth with short, stiff, bluish green foliage. 2 to 3 ft., \$1.00 each; 3 to 4 ft., \$1.75 each; 4 to 5 ft., \$2.50 each.

White Pine (*P. strobus*). A lofty native tree. Silvery green foliage. Does well on sandy soil. 2 to 3 ft., \$1.00 each; 3 to 4 ft., \$2.00 each; 4 to 5 ft., \$3.00 each; 5 to 6 ft., \$4.50 each; 6 to 7 ft., \$7.00 each; 7 to 8 ft., \$8.00 each; 8 to 10 ft., \$10.00 each.

Retinospora (Japan Cypress) - Chamaecyparis

Plume Cypress (*R. plumosa*). Erect branches with side shoots of a plume-like arrangement; graceful, feathery, green foliage. 1½ to 2 ft., \$1.25 each; 2 to 2½ ft., \$1.50 each; 2½ to 3 ft., \$1.75 each; 3 to 4 ft., \$2.50 each.

Golden Plume Cypress (*R. plumosa aurea*). A golden form. 1½ to 2 ft., \$1.25 each; 2 to 2½ ft., \$1.50 each; 2½ to 3 ft., \$1.75 each; 3 to 4 ft., \$2.50 each.

Sawara Cypress (*R. pisifera*). An upright, graceful tree with flattened branchlets; foliage green. 1½ to 2 ft., \$1.00 each; 2 to 2½ ft., \$1.50 each; 2½ to 3 ft., \$1.75 each; 3 to 3½ ft., \$2.50 each; 3½ to 4 ft., \$3.50 each.

Thread Cypress (*R. filifera*). The long, thread-like branches are very pendulous; lateral stems of bright green. 18 to 24 in., \$2.00 each; 2 to 3 ft., \$2.50 each; 3 to 4 ft., \$4.00 each; 4 to 5 ft., \$5.50 each.

Spruce - Picea

Colorado Green Spruce (*P. pungens*). A stately evergreen of symmetrical habit, having sharp, dull green needles on horizontal branches. 2½ to 3 ft., \$2.00 each; 3 to 4 ft., \$2.50 each; 4 to 5 ft., \$3.00 each; 5 to 6 ft., \$4.00 each.

Colorado Blue Spruce (*P. pungens glauca*). The well known Colorado Blue Spruce. 18 to 24 in., \$2.00 each; 2 to 2½ ft., \$3.50 each; 2½ to 3 ft., \$4.50 each; 3 to 4 ft., \$5.50 each; 4 to 5 ft., \$7.50 each; 5 to 6 ft., \$10.00 each.

Koster's Blue Spruce (*P. pungens kosteri*). The bluest of all the Spruces. 2 to 2½ ft., \$5.00 each; 2½ to 3 ft., \$6.00 each; 3 to 3½ ft., \$7.50 each; 3½ to 4 ft., \$10.00 each; 4 to 4½ ft., \$12.50 each; 4½ to 5 ft., \$14.00 each; 5 to 6 ft., \$15.00 each; 6 to 7 ft., \$20.00 each.

Dwarf Alberta Spruce (*P. glauca conica*). A beautiful, compact cone-shaped evergreen with dense foliage. Dwarf. 12 to 15 in., \$2.00 each; 15 to 18 in., \$3.00 each.

Norway Spruce (*P. excelsa*). 1½ to 2 ft., 60c each; 2 to 3 ft., 85c each; 3 to 4 ft., \$1.25 each; 4 to 5 ft., \$2.00 each; 5 to 6 ft., \$3.50 each.

Pygmy Spruce (*P. excelsa pygmaea*). This little tree of dwarf and compact habit, makes an ideal plant for rockeries. 6 to 8 in., \$1.25 each; 8 to 10 in., \$1.50 each; 10 to 12 in., \$2.00 each.

White Spruce (*P. canadensis*). An upright grower with light silvery green foliage. 12 to 18 in., 60c each; 18 to 24 in., 85c; 2 to 3 ft., \$1.00; 3 to 4 ft., \$1.50; 4 to 5 ft., \$2.50; 5 to 6 ft., \$4.00.

Yew - Taxus

Canadian Yew (*T. canadensis*). Low, spreading shrub with pale green foliage. Preferable for shady plantings. 15 to 18 in., \$1.50 each; 18 to 24 in., \$2.25 each.

Columnar Yew (*T. cusp. int. columnaris*). This variety grows extremely upright and narrow like the Irish Juniper and can be used in many places where a narrow tree is desired. 15 to 18 in., \$1.50 each; 18 to 24 in., \$2.00 each; 2 to 2½ ft., \$2.50 each; 2½ to 3 ft., \$3.50 each; 3 to 3½ ft., \$5.00 each; 3½ to 4 ft., \$7.50 each.

Dwarf Hedge Yew (*T. canadensis stricta*). Especially adapted for a dwarf edging for gardens or border plantings. 8 to 10 in., 75c each; 10 to 12 in., \$1.00 each; 12 to 15 in., \$2.00 each; 15 to 18 in., \$3.00 each.

Japanese Yew (*T. cuspidata*). One of the most desirable of the low growing evergreens. The foliage is dark green; spreading habit and very hardy. 15 to 18 in., \$1.50 each; 18 to 24 in., \$2.25 each; 2 to 2½ ft., \$3.25 each; 2½ to 3 ft., \$4.50 each; 3 to 3½ ft., \$7.50 each; 3½ to 4 ft., \$10.00 each.

Upright Japanese Yew (*T. cuspidata capitata*). An upright form of the above. 15 to 18 in., \$1.50 each; 18 to 24 in., \$2.50 each; 2 to 2½ ft., \$3.50 each; 2½ to 3 ft., \$5.00 each; 3 to 3½ ft., \$7.00 each; 3½ to 4 ft., \$9.00 each.



Dwarf Japanese Yew.

Intermediate Japanese Yew (*T. cuspidata intermedia*). The habit of growth is more dense and the foliage darker than the Japanese. 12 to 15 in., \$2.00 each; 15 to 18 in., \$2.50 each; 18 to 24 in., \$3.50 each.

Dwarf Japanese Yew (*T. cuspidata nana brevifolia*). An excellent dwarf variety with very dark green foliage. 12 to 15 in., \$2.00 each; 15 to 18 in., \$2.50 each; 18 to 21 in., \$3.75 each; 21 to 24 in., \$6.00 each.



Columnar Yew.

Evergreen Shrubs

These splendid plants hold their rich green foliage all the year round, and in many varieties make a magnificent showing of bloom. Shaded situations are preferred by most of the varieties.

ANDROMEDA (*Pieris*) **floribunda** (Lily-of-the-valley Shrub). Beautiful, hardy shrub. In early April it is covered with showy spikes of white flowers. 12 to 15 in., \$1.75 each; 15 to 18 in., \$2.25 each.

DAPHNE **cneorum** (Rose Daphne). A most attractive, dwarf, almost prostrate shrub. In May, and again in August, it bears beautiful flower clusters of a delightful shade of pink. For rock gardens it is very desirable. 6 to 9 in., 50c each; 9 to 12 in., 75c each; 12 to 15 in., \$1.00 each; 15 to 18 in., \$1.50 each; 18 to 24 in., \$2.25 each.

EUONYMUS **radicans**. Very hardy, dense-growing trailing vine; dull green leaves, with whitish veins; grows rapidly; self-clinging. 40c each; \$4.00 per doz.; \$30.00 per 100.

radicans **variegata**. Similar in habit to the above. Foliage green and white. 40c each, \$4.00 per doz.

r. kewensis. The smallest *Euonymus*. The leaves are about $\frac{1}{4}$ inch wide and a little longer. As a low evergreen ground-cover it forms a perfect mat of green. A fine variety for the rock garden, low walls, low slopes and edge of pools. 3-yr., 35c each; \$3.50 per doz. 4-yr., 40c each; \$4.00 per doz.

r. vegetus. A pretty, low trailing evergreen with aerial rootlets which cling to any support. Has round leaves and produces an abundance of showy red fruits with yellow pods. 2-yr., 35c each; \$3.50 per doz.; \$28.00 per 100. 3-yr. 50c each; \$5.00 per doz.; \$35.00 per 100.

HEATHER (*Calluna vulgaris*). The Heathers are compact, low-growing plants, and as such are extremely useful for rockeries. The small foliage is densely arranged around the wiry little stems, and either when in full bloom or in midwinter makes a very pretty picture. 6 to 8 in., 50c each; 8 to 10 in., 75c each.

LEUCOTHOE (*Andromeda*) **catesbaei**. A valuable shrub in shady positions. Flowers are fine, white, and are borne in long, pendulous racemes. 12 to 18 in., \$1.50 each; 18 to 24 in., \$2.00 each.

MOUNTAIN LAUREL (*Kalmia latifolia*). Grows 8 ft. high, with broad, glossy green foliage. The rose colored flowers, in large and showy clusters at the ends of the shoots, appear in June. 12 to 15 in., \$1.00 each; 15 to 18 in., \$1.25 each; 18 to 24 in., \$1.75 each; 2 to 2½ ft., \$2.25 each; 2½ to 3 ft., \$3.50 each.

PACHYSANDRA **terminalis** (Japanese Spurge). The best ground cover under shrubs of all kinds. Grows only 6 in. high and has dark green foliage. 25c each; \$2.50 per doz.; \$15.00 per 100.

RHODODENDRON **carolinianum** (Carolina Rhododendron). Leaves rather small, narrow, dark green above, covered with brownish dots beneath; clusters of clear rose-pink flowers in May; very hardy. 12 to 15 in., \$1.25 each; 15 to 18 in., \$1.75 each; 18 to 24 in., \$2.25 each; 24 to 30 in., \$2.75 each.

White Carolina, 12 to 18 in., \$2.50 each.

catawbiense (Catawba Rhododendron). One of the most beautiful native shrubs and the hardiest of all the Rhododendrons. Color, rosy purple. 12 to 15 in., \$1.75 each; 15 to 18 in., \$2.00 each; 18 to 24 in., \$2.50 each; 2 to 2½ ft., \$3.50 each; 2½ to 3 ft., \$4.50 each.

catawbiense compacta. 12 to 15 in., \$2.75 each; 15 to 18 in., \$3.50 each; 18 to 24 in., \$4.50 each.

maximum (Great Laurel). A well known native of our mountain regions, with great clusters of white or rose-pink flowers in June and July. 15 to 18 in., \$1.75 each; 18 to 24 in., \$2.00 each; 2 to 2½ ft., \$2.75 each; 2½ to 3 ft., \$3.50 each.

VINCA **MINOR** (Myrtle or Common Periwinkle). A handsome evergreen trailing plant with showy bright blue flowers borne freely in early spring. A good shade-growing ground-cover plant. 25c each, \$2.50 per doz., \$15.00 per 100.

YUCCA **filamentosa** (Adams Needle). Handsome, creamy white flowers, much branched and densely packed with bloom, with swordlike foliage. 40c each.



Andromeda.

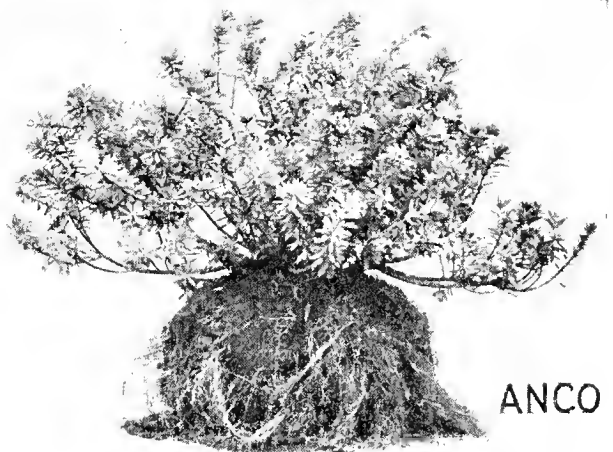

Daphne Cneorum.



Rhododendron Maximum.

Fruit Trees

Apples

(STANDARD)

Each Doz.

2-yr., 6 to 7 ft.\$1.00 \$10.00

SUMMER VARIETIES

Red Astrachan. Red, large. Aug.
Sweet Bough. Pale yellow, large. Aug.

AUTUMN APPLES

Fameuse, or Snow. Crimson. Nov. to Jan.
Gravenstein. Red striped, large. Oct.
Wealthy. Deep red, white flesh.

WINTER VARIETIES

Baldwin. Red, large.
Cortland. A beautiful red; larger than McIntosh and ripening a month later.
Delicious. Large, red.
Hubbardston Nonesuch. Yellow and red, large.
McIntosh Red. One of the best, red; Nov., Feb.
Northern Spy. Yellow and red; large.
Rhode Island Greening. Greenish yellow; large.
Roxbury Russet. Medium to large. Dec. to June.
Talman Sweet. Yellow, medium size. Nov. to April.

DWARF APPLES

\$1.25 each, \$12.50 per doz.

Delicious	McIntosh	Wealthy
R. I. Greening	Yellow Transparent	

CRAB APPLES

\$1.00 each, \$10.00 per doz.

Hyslop. Dark crimson; large.
Transcendent. Yellow and red striped; large.

Cherries

\$1.00 each, \$10.00 per doz.

Black Tartarian. Purplish black; large. June.
Early Richmond. A preserving variety.
Gov. Wood. Yellow and red; large. June.
Montmorency. A large, preserving variety.
Napoleon. Yellow and red; large. July.
Windsor. A large, deep colored variety of good flavor.
Yellow Spanish. Pale yellow, red cheek. June.

Pears

5 to 7 ft., \$1.00 each, \$10.00 per doz.

SUMMER VARIETIES

Bartlett. Yellow and large.
Clapp's Favorite. Yellowish green, large.

AUTUMN VARIETIES

Anjou. Greenish yellow. Nov. to Dec.
Beurre Bosc. Russet color; large. \$1.50 each.
Seckel. Yellowish russet; small.
Sheldon. Yellowish russet; medium size.

WINTER VARIETIES

Duchess. Very large, yellow, with a dull red cheek.

DWARF PEARS

\$1.00 each, \$10.00 per doz.

Anjou, Bartlett, Clapp's Favorite, Seckel.



Delicious Apple.

Peaches

60c each; \$6.00 per doz.

Belle of Georgia. White, red cheek; large, very late.
Carman. Pale yellow with red blush. Large, with sweet flavor.
Champion. Creamy white, red cheeks; large. Aug. 1.
Crawford's Early. Yellow and red; large. Aug.
Crawford's Late. Yellow and red; large. Sept.
Elberta. Large; light yellow. Aug.
Greensboro. White with red cheek. Early.
J. H. Hale. Large, yellow. Freestone. Sept.
Mountain Rose. Large, red, with white flesh; early.
Oldmixon Free. White and red; large. Sept.

Plums

Trees, 5 to 7 ft., \$1.00 each, \$10.00 per doz.

Bradshaw. A very large. oval; dark violet-red; juicy, sweet and good.
Coe's Golden Drop. Very large; light yellow; rather firm; rich, sweet and good; adheres to the stone.
Damson. Last of September. Small, dark purple; valued for preserving.
Lombard. Medium oval; violet-red, juicy, pleasant and good; very productive.

JAPAN PLUMS

Abundance. Lemon-yellow ground, overspread with bright cherry, and a heavy bloom; large.
Burbank. Large and beautiful; clear cherry-red.

Quinces

75c each, \$8.00 per doz.

Apple, or Orange. Large, roundish, bright golden yellow; very productive. Early to late.
Champion. Large, yellow, very productive and ripening very late.

Small Fruits

Grapes

35c each, except where noted.

BLACK

Campbell's Early. Very large and sweet; early. 50c each.
Concord. Large, always reliable. Medium.
Moore's Early. Early.
Worden. Large, early.

RED

Brighton. Large, early.
Delaware. Small, delicious. Late.
Catawba. Late.

WHITE

Green Mountain. One of the best. Early.
Moore's Diamond. Early.
Niagara. Medium.

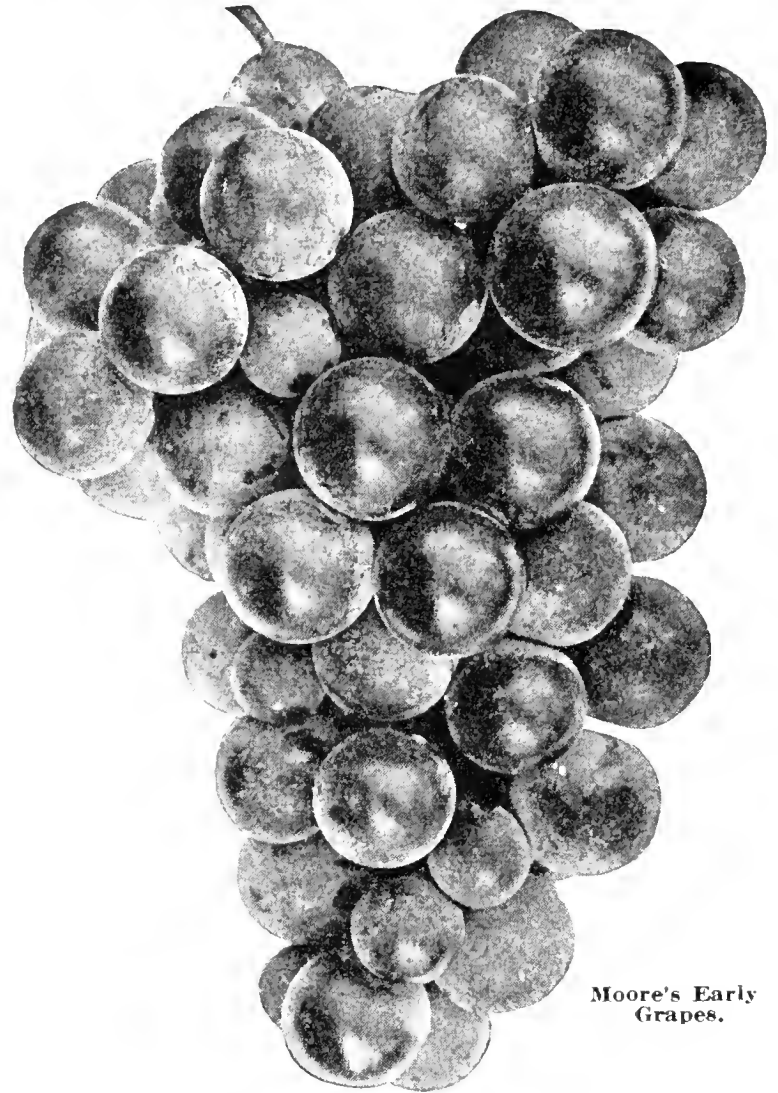

Moore's Early Grapes.

Blackberries

\$1.00 per doz., \$6.00 per 100.

Eldorado. Extra fine and very hardy; large, sweet berry.
Rathbun. Very large, sweet and delicious.
Snyder. Medium size; very fine. Medium.

Raspberries

\$1.00 per doz., \$6.00 per 100.

Columbian. Purple fruit, delicious for table.
Cuthbert. Medium to large, red, sweet.
Golden Queen. Large, yellow; fine quality.
St. Regis Everbearing. Large, bright crimson berries.
Herbert. Large, sweet, bright red.

Strawberries

The Strawberry will grow in any good garden soil where the ground has been thoroughly prepared. For family use we recommend planting them in double rows, 1 foot apart each way and 5 feet between the double rows, allowing a sufficient number of runners to grow into the wide passage to cover about 1½ feet on each side; all the rest should be pinched off. It is advisable to cover the plants in winter with litter, which should be removed as soon as the plants commence to grow in spring.

Layer plants in spring, \$3.00 per 100, \$8.00 per 1000, except where noted.

Pot-grown plants after August 1st.

Abington. Strong grower and great yielder. The bright red berries are of very large size, firm and fine flavor. Early to medium.
Arabine. Extra early, very large, bright red of high quality, very robust grower and heavy cropper.
Barrymore. Awarded silver medal and three first premiums by the Massachusetts Horticultural Society, in 1908. A great berry for all purposes. Large size, rich, dark, glossy, crimson color; conical shape; flesh red and quality excellent. Medium.
Big Joe. A magnificent new Strawberry of robust growth and very prolific. The berries are light crimson in color and very large. Medium.



Mastodon Everbearing Strawberries.

Brandywine. Large, roundish, conical, bright glossy crimson berries, firm and solid; excellent quality and fine flavor. Medium.
Commonwealth. Large, glossy crimson berry, of excellent quality, a great cropper and one of the latest.
Gibson. Very large, deep red, fine flavor. Medium.
Glen Mary. Very large, highly colored, firm, and ranks with the best in flavor. Medium to late.
Golden Gate. New seedling, resembles the Marshall and will succeed where the Marshall fails. It produces strictly fancy, firm fruit clear to the end of the season, of a rich, crimson color.
Judith. A large, medium red, pointed berry; a good market variety; very early.
Marshall. Large rich crimson, fine flavor. One of the most popular sorts. Medium.
Premier. One of the best of the extra early varieties, does well in almost any section; excellent quality; bright red.
Senator Dunlap. Dark red berries of medium size. The flesh is red all through and exceedingly juicy. Early mid-season.
Warren. Dark, blood red, extra size, broad and flattened at tips, borne on large clusters. Medium.

EVERBEARING STRAWBERRIES

Mastodon. Truly a Wonderberry, in size, flavor and yield. \$4.00 per 100.
Progressive. The fruit is rich and sweet, a deep red inside and out; of good medium size and quite firm. \$3.50 per 100.
Superb. Perfect blossoms. Enormous crops in June, and in September. It does not fruit on new runners. \$3.50 per 100.

All prices subject to change without notice.

Farm, Garden and Lawn Requisites, Tools, Etc.

- Asparagus Buncher.** Makes bunches of size usually sold in Boston market. \$5.00 each.
- Asparagus Knife.** Also used as a weeder. 25c to 50c each.
- Axes.** Warranted steel, Witherell's extra quality, handled. \$2.50 to \$3.50 each.
- Bamboo Poles.** 20 feet. 50c each, \$5.00 per doz.
- Bands, Rubber.** For bunching Asparagus, Celery, Beets, Radishes, etc. Used in place of twine or tape. In 1-lb. boxes, \$1.00 per lb.
- Bars, Crow.** Solid cast steel. Per lb. 15c.

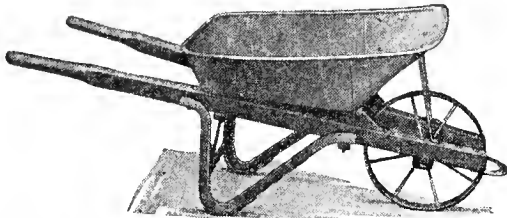

Barrow, Steel Tray Contractors'. For conveying concrete, mortar, sand, gravel, cement, fertilizer, etc. Strongly reinforced. Pressed steel tray.
 No. B27—Capacity 3½ cubic feet\$9.00
 No. 21—Capacity, 2½ cubic feet 6.00

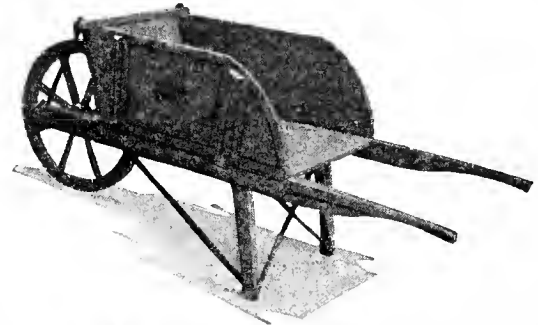

Barrow, New England Garden. This is a strong, well-made barrow; the frame is made from best seasoned timber, nicely painted and striped, it has an eight-spoke, steel axle, wood wheel. We consider it the best garden barrow manufactured. Three sizes, No. 64, medium, \$8.00; No. 65, large, \$9.00; No. 66, extra large, \$10.00.
Barrows, equipped with 16x4 inch pneumatic rubber tire wheels, \$8.00 extra.
Barrow, Greenhouse. Made especially for greenhouse. Long narrow bodies with wood wheel. \$10.00.
Barrow Leaf Rack. Made of galvanized wire, with wood bottom, capacity ten bushels. \$10.00.

Shelton's Baskets

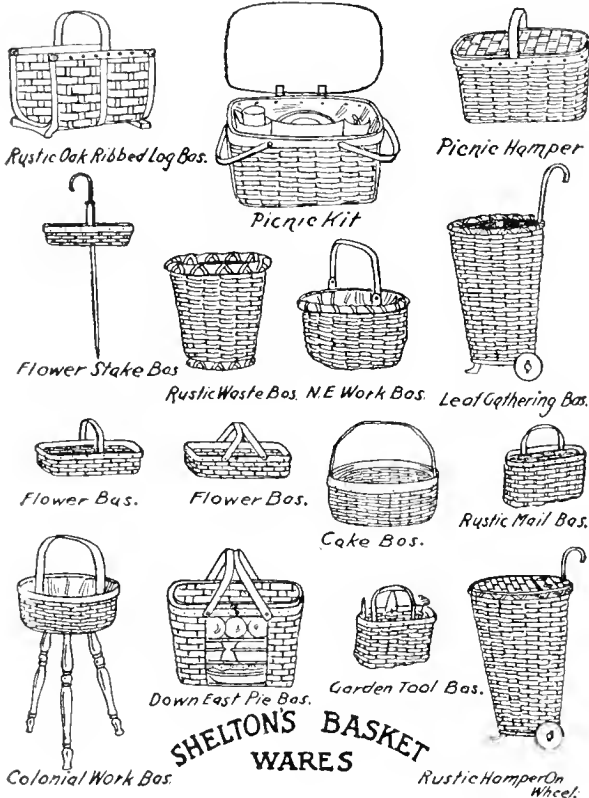

Rustic Oak Ribbed Log Basket. Made of hand drawn oak, and braced with oak ribs. Finished in walnut, with brass trimmings. Three sizes, \$3.00, \$3.50, \$4.00.
Rustic Waste Basket. Walnut finish. Two sizes, \$1.75, \$2.00.
Rustic Mail Basket. For replacing the commonplace mail box. Walnut finish. Also useful for garden tools. Price \$1.25.
Colonial Work Basket. An odd piece for the home or garden; very distinctive. Antique maple finish. Price \$4.50.
Flower Stake Basket. Made of hand drawn oak, finished in walnut and has a rustic cane with sharp ferrule to permit of easy insertion into the ground. Price \$4.50.
New England Work Basket. A quaint New England garden and work basket. Walnut finish. Three sizes, \$1.50, \$1.75, \$2.00.
Miniature Work Basket. Lined with old-fashioned chintz patterns. A distinctive gift. Delicately perfumed. Price \$1.50.
Leaf Gathering Basket. A handy basket for use about the lawn for gathering leaves, grass, etc.; made of hand-drawn oak. Price \$7.50.
Down East Pie Basket. Designed for packing pies, cakes or sandwiches for picnics, etc., and intended to prevent crushing. Made with three compartments as illustrated, and in a shallower model with but two compartments. Prices \$2.75 and \$3.50.
Flower Basket. For flowers and garden tools; and also a popular sandwich basket for bridge, beach and lawn parties. Walnut finish. Three sizes, \$1.25, \$1.50, \$1.75.
Cake Basket. A basket for carrying cake or sewing. Fitted with curiously shaped handle. Walnut finish. Price \$3.00.
Rustic Hamper on Wheels. Walnut finish. Price \$9.50.
Shelton Picnic Kit. A well-built basket, made of hand drawn ash, oak runners, and finished in walnut. Sold with complete service for four, consisting of green beetle ware tumblers and plates, stainless steel knives and forks, and silver-plated spoons. Price \$9.00.
Shelton Picnic Hamper. Picnic hamper, with the old-fashioned woven double cover. Finished in walnut, with brass trimmings. Price \$4.00.

Baskets, Tomato or Pansy. Wire handles, also used for fruit as well as plants. 100 1000
 3-quart size\$4.00 \$35.00
 2-quart size 3.00 23.00

Baskets, Picking. For gathering fruit or vegetables. Swing or stationary ball. 1 pk. 75c, ½ bu. \$1.00, 3 pks. \$1.25.

Baskets, Shepherd. 1 bu. \$2.50 each; 2 bus. \$4.00 each.

Baskets. For holding leaves. 4 bus. \$4.00 each.

Baskets, Vegetable. ¼ bu. \$1.00 each; ½ bu. \$1.25 each; ¾ bu. \$1.50 each; 1 bu. \$1.75 each.

Baskets, Wire Hanging. Either round or flat bottom. 6 in. 30c each; 7 in. 40c each; 8 in. 50c each; 10 in. 60c each; 12 in. 70c each.

Bill Hooks. For heavy pruning. English. \$3.00.

Boxes for Cut Flowers. The following sizes are kept in stock.

No.	Length	Width	Depth	Doz.	100
1	18 in.	5 in.	3 in.	\$1.00	\$ 6.00
2	21 in.	5 in.	3½ in.	1.20	7.00
3	24 in.	5 in.	3½ in.	1.40	8.00
4	30 in.	5 in.	4 in.	1.60	9.00
5	21 in.	8 in.	5 in.	1.80	10.00
6	24 in.	8 in.	5 in.	2.00	11.00
7	28 in.	8 in.	5 in.	2.25	13.00
8	36 in.	8 in.	5 in.	2.50	16.00

Corrugated Shipping.

Size Inches	Each	Doz.
B 24x12x6	\$.50	\$5.00
C 30x12x7	.60	6.00
D 36x12x9	.70	7.00
E 40x15x9	.80	8.50
F 48x15x9	1.00	10.00

SHELTON'S BASKET WARES

Farm, Garden and Lawn Requisites, Tools, Etc.

Burlap. For putting around trees to trap gypsy moths. 8 in. wide, 8c per yard; 100 yards \$7.00. 40 in. wide, 18c per yard; piece about 100 yards, 16c per yard.

Burning Brands. For marking tools, etc. Six letters or less, \$5.00; each additional letter, \$1.00.

Bush Hooks. Strapped-eye handle, \$2.00.

Carnation Support, Excelsior. Heavy galvanized wire. In two sizes, 13 in., \$3.00 per 100; 20 in., \$3.50 per 100. One of each length makes a complete plant support.

Cotton Wadding. Large sheets, for protecting plants and flowers from frost. 12c each, \$1.25 per doz., \$8.00 per 100.

Cultivator, The Norcross Hand Garden. Does the work easier and faster than any wheel hoe.

5 prong, 4 ft. handle \$1.25

3 prong, 4 ft. handle 1.00

3 prong, 9 in. handle50

Celery Wrappers. Best quality parchment paper, printed. 12x15 in., pkt. 1000 sheets, \$3.50.

Dibbles. Steel points, wooden or iron handle. 75c each.

Edging Knife, American. \$1.25. Long or D Handle.

Edging Knife, English. \$2.50 each. Handles, extra, 50c.

Electric Tape. For mending hose, etc. 40c per coil.

Flower Pot Saucers, Thermold Rubber. Breakproof—leak-proof. Made of a durable and sturdy rubber compound with cleated bottom to allow water to drain through the flower pot. Can be used on polished surfaces without scratching the finish.

No. 1—For 4 in. pot \$0.15 \$1.50

No. 2—For 4½ or 5 in. pot20 2.00

No. 3—For 6 in. pot25 2.50

No. 4—For 6½ or 7 in. pot30 3.25

No. 4A—For 7½ or 8 in. pot35 3.75

No. 5—For 9 in. pot45 5.00

No. 6—For 10 in. pot65 7.00

No. 7—For 12 in. pot90 10.00

Hews Flower Pot, Standard. Measurement from inside to inside. Width and depth equal.

Inches	Doz.	100	Inches	Doz.	100
2	\$.25	\$1.50	7	\$2.25	\$17.00
3	.35	2.50	8	3.25	24.00
4	.50	3.75	9	4.50	35.00
5	.90	6.75	10	6.50	50.00
6	1.40	10.00	12	12.00	90.00

No. 1—For 4 in. pot \$0.15 \$1.50

No. 2—For 4½ or 5 in. pot20 2.00

No. 3—For 6 in. pot25 2.50

No. 4—For 6½ or 7 in. pot30 3.25

No. 4A—For 7½ or 8 in. pot35 3.75

No. 5—For 9 in. pot45 5.00

No. 6—For 10 in. pot65 7.00

No. 7—For 12 in. pot90 10.00

Flower Pot Hanger, Krich's Perfect. No. 1 will fit from 3½ to 5 in. pots, 50c per doz. No. 2 will fit from 5 to 8 in. pots, 60c per doz. No. 3 will fit from 8- to 12-in. pots, 75c per doz.

Bulbs and Seed Pans, Round.

Size	Each	Doz.	Size	Each	Doz.
6 in.	\$.015	\$1.50	9 in.	\$.050	\$4.50
7 in.	.20	2.25	10 in.	.65	6.50
8 in.	.30	3.25	12 in.	1.25	12.00

Flower Pots, Neponset Black. Made of tough waterproof paper, eliminating breakage. Superior to any other pot on the market for the actual growing and transplanting of plants. Not less than one case at 1000 price.

Inches	In case	Doz.	100	1000
2¼	1000	\$.015	\$0.60	\$ 5.00
2½	1000	.20	.75	5.50
3	1000	.25	1.00	6.50
3½	1000	.30	1.25	8.75
4	500	.40	1.50	10.00
6	500	.60	2.50	17.50

Flower Pots, Neponset Red. For storage, transplanting, and shipping. Specially treated and water-resistant. Not less than one case at 1000 price.

Inches	In case	Doz.	100	1000
2¼	1000	\$.010	\$0.50	\$ 4.25
2½	1000	.15	.60	4.75
3	1000	.20	.75	5.75
3½	1000	.25	1.00	7.50
4	500	.30	1.25	9.00
5	500	.40	1.50	12.00
6	500	.50	2.00	16.00

Flower Vases, Galvanized Iron. Strong, light, durable, made of good material with heavy hoop at base of can to reinforce bottom of vase. These vases are finished in a moss green enamel baked on.

No.	Top Diam.	Bot. Diam.	Hght.	Each	Doz.
5	7¾ in.	5½ in.	11 in.	\$.100	\$11.00
6	7¾ in.	5½ in.	17 in.	1.25	14.00
7	8 in.	6¼ in.	11 in.	1.00	11.00
8	9 in.	7¾ in.	12 in.	1.25	14.00
9	9 in.	7¾ in.	17 in.	1.50	16.00
10	6½ in.	5 in.	14 in.	1.00	11.00
11	5½ in.	4¼ in.	15 in.	1.00	11.00
12	5 in.	4 in.	9½ in.	.90	10.00

Floral Tools, "American." These tools are not toys, but serviceable tools, of high grade material, well made and finished.

Per Set

No. 4, P. S. F. 4-Piece Set: Shovel, Rake, Hoe,

and Spading Fork \$3.00

No. 3 P. F. 3-Piece Set: Shovel, Rake and Hoe 2.00

Extra Rakes for above set Each .60

Extra Spading Forks Each 1.00

Extra Hoes Each .90

Extra Floral Shovels Each .90

Fork, Ensilage. 8 tine, D handle, strapped Each

Forks, Hand. For transplanting, American50

Forks, Hand. For transplanting, English 1.25

Forks, Hay. 4 to 6 ft., bent handles \$1.50 to 2.25

Forks, Manure. 4 tine, mal. D handle, strapped 1.75

Forks, Manure. 5 tine, mal. D handle, strapped 2.00

Forks, Manure. 6 tine, mal. D handle, strapped 2.25

Forks, Manure. 4 tine, wood D handle, strapped 2.00

Forks, Manure. 5 tine, wood D handle, strapped 2.25

Forks, Manure. 6 tine, wood D handle, strapped 2.50

Forks, Manure. 4 tine, long handled, strapped 1.75

Forks, Manure. 5 tine, long handled, strapped 2.00

Forks, Manure. 6 tine, long handled, strapped 2.25

Forks, Spading. 4 tine, long handled, strapped 1.75

Forks, Spading. 4 tine, mal. D handle, strapped 1.75

Forks, Spading. 4 tine, wood D handle, strapped 2.00

Forks, Spading. 5 tine, mal. D handle, strapped 2.25

Forks, Stone. 8 tine, mal. D handle, strapped 2.75

Garden Lines, Braided. 100 ft. \$1.25, 200 ft. \$2.25.

Garden Line Reels. Small \$1.50, large \$2.00 each.

Glass Cutter. 25c and 50c each.

Glaziers' Points (Perfection). Will stop glass from slipping

Made of steel wire galvanized. Double point. Per box of

1000, No. 2, 75c; No. 2½, 85c.

Glaziers' Points (Zinc City). Made of zinc. Will not rust

In three sizes, ¼, ½ and ¾ in. long. Each size, 65c

per lb.

Gloves, Gardeners' Pruning. With gauntlets. \$2.00 per pair;

without gauntlets, \$1.50 per pair.

Grafting Knife, or Chisel. All steel, \$1.25 each.

Grafting Wax. ¼ lb. 20c, ½ lb. 30c, 1 lb. 50c.

Grass Hooks, or Sickles. English, No. 2, \$1.00 each; No. 4,

\$1.25 each; American, 50c and 75c each.

Grindstones, "Nova Scotia." Mounted on selected hardwood

frames. Sizes vary from 20 in. to 30 in. in diameter.

Prices from \$20.00 to \$30.00 each.

Wayward Vine Guide and Support

New—Practical.

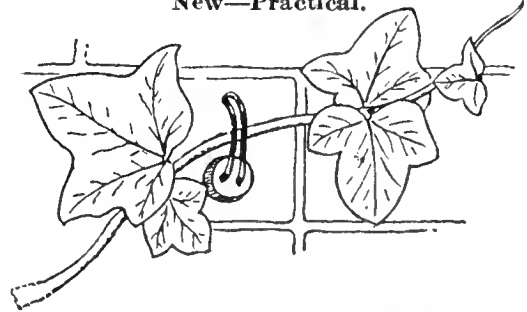

For training and supporting Ivy, Small Fruiting Trees, and all other Vines, etc., on brick walls or any other surface without defacing it.

Price: \$1.00 for box of 25, including cement. Special price on quantity lots. Red—White—Grey.

Hammer, Nail. Adze eye, bell face. \$1.00 to \$1.50 each.

Hammer, Stone Striking. Solid cast steel. 25c per lb.

Hatchet, Barrel. \$1.00 to \$1.50 each.

Hatchet, Axe Pattern. \$1.25 and \$1.50 each.

Handles, Axe. Extra quality hickory. 75c each.

Handles, Hammer. Extra quality hickory. 50c each.

Handles, Pick. Extra quality hickory. 75c each.

Handles, Hay Fork. Extra quality ash. 50c to \$1.00 each.

Handles, Hoe. Extra quality ash. 35c each.

Handles, Manure Fork. 75c to \$1.25 each.

Handles, Shovel and Spade. 75c each.

Handles, Rake. 50c each.

Hoes, Nurserymen's Two-pronged Steel. \$2.50 each.

Farm, Garden and Lawn Requisites, Tools, Etc.

- Hoes, Boothby-toothed. \$1.50 each.
- Hoes, Humphrey. \$1.25 each.
- Hoes, American Scuffle, Handled. 8 in. \$1.25.
- Hoes, English or Dutch Scuffle. 3 in., \$1.00; 4 in., \$1.10; 5 in., \$1.25; 6 in., \$1.35; 7 in., \$1.50; 8 in., \$1.65; 9 in., \$1.75 each. Handled, extra 50c.
- Hoes, Grading. 7 in. blade, 4 ft. handle. \$2.50 each.
- Hoes, Market Gardeners' Slide or Scuffle (Arlington). Handled, 4 in. to 9 in. \$3.00 each.
- Hoes, Garden, Socket Draw. 8 in. \$1.25 each.
- Hoes, Meadow. 9 in. \$1.35; 10 in. \$1.50 each.
- Hoes, Warren. \$1.50 each.
- Hoes, Mortar or Street. 10 in., \$1.50 each.
- Hoes, Ladies' and Boys'. 75c and \$1.00 each.
- Hoes, Onion. \$1.25 each. Square or round top.
- Hoes, Weeding. 6 tooth. \$1.00 each.

Hose, Rubber Garden, "Dreadnaught Brand." A braided hose made of the best materials. Does not kink. We offer this in 25 and 50 ft. lengths coupled; also in continuous lengths of 500 feet. 1/2 in. at 18c per ft.; 3/4 in. at 20c per ft.

- Hose Reels.** All metal, strong, substantial hose reels for gardens or lawns. Made with high wheels, almost indestructible.
 - No. 10, holding 100 ft. \$4.50 each.
 - No. 20, holding 150 ft. \$5.00 each.
- Hose Connection, Shut-off.** For use with any nozzle that has no shut-off where one is desired. \$1.00 each.
- Hose Connection, Siamese.** \$1.00 each.
- Hose Couplings.** 1/2, 5/8 and 3/4 in., per set, 25c each.
- Hose Mender (Hudson's Pattern).** Wizard sheet brass tubes. Substantial yet light in weight. Does not obstruct water way of hose. 1/2, 5/8 and 3/4 in. 5c each, 50c per doz. Wires, 25c per doz., \$1.75 per 100.
- Hose Mender, Cooper's.** Made of heavy brass, requires no wires or pliers to adjust it. 10c each, \$1.00 per doz.
- Hose Menders, Perfect Clinching.** In one piece, doing the work of the mender tube and two clamps ordinarily used. 1/2, 5/8 and 3/4 in., 10c each, \$1.00 per doz.
- Hose Clamps.** Made of galvanized steel with screw adjustment. 1/2 and 3/4 in., 5c each, 50c per doz.
- Hose Reducers.** For connecting 1/2 in. and 3/4 in. hose couplings with Bordeaux or Vermorel nozzles. 35c each.
- Hose Nozzle, Bordeaux Spray.** \$1.25 each.
- Hose Nozzle, New Boston.** Will throw a coarse or fine spray or a large or small stream. 75c each.
- Hose Nozzle, Stott's.** Specially recommended for greenhouse spraying. Throws a forcible side spray. Single spray, \$2.00 each; double spray, \$3.00 each.
- Hose Nozzle, Rose Spray.** For greenhouse, flower garden, hotbed, etc. Heavy brass, 3 in. face, \$1.00 each; 4 in. face, \$1.25 each. Light brass, 3 in. 75c each; 4 in. \$1.00 each. "Greenhouse," with coarse and fine 4 in. spray, \$2.50 each.
- Hose Nozzle Holder "Aquamatic."** Any hose nozzle can be attached; entirely of brass. By a pressure of the fingers on the handle, the spray is turned on, by releasing the pressure the spray automatically shuts off. \$1.25 each.
- Hose Washers, Rubber.** For 1/2 in. and 3/4 in. hose. Doz. 10c, 1/4 lb. 35c, lb. \$1.00.
- Knives, Budding and Pruning.** Imported. In various styles, \$1.50 to \$5.00 each.
- Labels, Copper.** Made of copper and copper wired. Indestructible and always legible. No. 1, 3 1/2 x 3/4 in., \$2.00 per 100; No. 2, 5 x 1 1/2 in., \$2.50 per 100.
- Labels, Simplex Weatherproof.** Made of celluloid with mica cover. (Price includes copper wires for attaching).

	Doz.	100
No. 1—3x 1/2 in.	\$0.50	\$3.00
No. 2—4x 3/4 in.75	5.00
No. 3—5x1 in.	1.00	7.00

Labels, Wood. For plants and trees.

	Plain or Painted	Plain	Painted
	100	1000	1000
4 in. Pot Label	\$0.30	\$1.80	\$ 2.20
5 in. Pot Label35	2.00	2.40
6 in. Pot Label40	2.25	2.75
8 in. Garden Label85	6.00	7.75
10 in. Garden Label	1.00	7.50	9.00
12 in. Garden Label	1.35	10.50	12.00
3 1/2 in. Tree Label25	1.50	2.00
3 1/2 in. Tree, iron wired30	2.00	2.50
3 1/2 in. Tree, copper wired35	2.25	2.70

Labels, The Perfect Garden Label. Marked with ordinary lead pencil this label is permanent in all garden conditions above or under the soil. This feature has been thoroughly tested. The material is indestructible. The beautiful cool gray-green color blends perfectly with foliage, soil and rocks. They should be set deep in the soil with only the marking space showing. Thus they are inconspicuous and do not interfere with weeding and cultivating. Any part of the label may be used as marking space for extensive notes. Markings are erasible with pencil eraser. Tie-on labels are supplied with wires in convenient bundles ready for attaching.

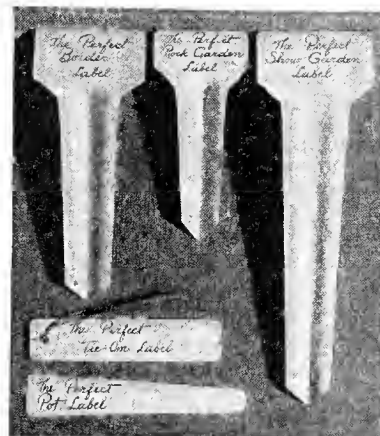

- Border size, 5 in. labels, 12, \$1.00; 25, \$2.00; 100, \$7.75.
- Rock Garden size, 4 in. labels. 12, 90c; 25, \$1.75; 100, \$6.75.
- Show Garden size, 7 in. labels. 12, \$1.25; 25, \$2.50; 100, \$9.50.
- Tie-on label 3/4 x 3 1/2 in., with wires, 50, \$1.75; 100, \$3.00.
- Pot label, 3/4 x 4 in., tapered. 50, \$1.50; 100, \$2.50.
- Lawn Rake, "MULTIPLEX" Flexible Spring Steel.** The MULTIPLEX Lawn Rake is a tool of exceptional merit; it meets the demand of the public for a rake that may be firmly adjusted to various widths (9 in. to 22 in.), as the occasion demands. It is sufficiently large for general use, and small enough for use among closely growing shrubbery. This is truly the most practical and useful Lawn Rake on the market today. Price, \$1.25 each.
- Mats, Hotbed.** Made by hand of the best rye straw. Size 6x6, \$3.25; 6x3, \$2.00.
- Mats, Hotbed.** 76x76 in. Covers two sash, made of heavy cotton or duck, filled and quilted. \$5.00 each.
- Mattocks.** Short cutter or grub hoe. 3 lbs. \$1.00 each.
- Mattocks, Long Cutter.** Extra quality. \$1.50 each.
- Mattocks, Pick.** Extra quality. \$1.25 each.
- Melon Nets.** For supporting Melons in the greenhouse. 25c each, \$2.50 per doz.
- Mole Traps, "Little Giant."** \$1.00 each.
- Oilers.** With spring bottom. 25c to 75c each.
- Oil, Harvester.** For mowers, reapers, etc. Gal. \$1.25.
- Pails, Stable.** Heavy galvanized iron. 10 qt. 40c, 12 qt. 50c, 14 qt. 50c.
- Paper, Green Waxed.** Sheets 12x18 in., lb. 50c; ream, about 3 lbs., \$1.25. Sheets, 24x36 in., lb., 50c; ream, \$4.00.
- Paper, White Tissue.** Sheets 20x30 in., lb. 40c; ream, about 7 lbs., \$2.00. Sheets 24x36 in., lb., 40c; ream, \$3.00.
- Paper, White Waxed.** Sheets 12x18 in., lb. 50c; ream, about 5 lbs., \$2.00. Sheets 24x36 in., lb., 50c; ream, \$4.00.
- Paper, White Wrapping.** Sheets 24x36 in., lb. 20c; ream, about 40 lbs. 18c per lb.
- Pencils, Indelible Label.** With point protector. Black or blue, 20c each. (Wolff's English Garden.)
- Picks, Contractor.** Best quality, \$1.50 each.
- Plant Tubs, Richmond Style.** Strongly made of selected white cedar and bound with electric welded wire; painted green. Without handles.

No.	Diam. inside	Each	No.	Diam. inside	Each
6	11 in.	\$1.00	10	15 in.	\$2.00
7	12 in.	1.25	11	16 in.	2.25
8	13 in.	1.50	12	17 in.	2.50
9	14 in.	1.75	13	18 in.	3.00

Farm, Garden and Lawn Requisites, Tools, Etc.

Plant Tubs, Cedar. For ferns, palms and other large plants. Made of thick cedar, nicely painted green. Drop handles. No. 2 and larger have hook handles. Outside measurements:

No.	Diam. across top	Height outside	Each
1	28 in.	22 in.	\$17.00
2	26 in.	20 in.	14.00
3	24 in.	18½ in.	9.00
4	22 in.	17 in.	7.25
5	20 in.	16 in.	6.25
6	18 in.	15 in.	5.00
7	17 in.	14 in.	4.25
8	16 in.	13 in.	3.75
9	14 in.	12 in.	3.00
10	12 in.	9½ in.	2.50

Plant Sprinklers, Scollay's Rubber. \$1.50 each.

Post Hole Digger. 4 ft. Atlas, \$2.00 each.

Poles, Wooden. 12 ft. long. Used for pruning and tree painting. 65c each; \$7.00 per doz.

Potato Hooks. Steel shank, 5 tine, \$1.50; 6 tine, \$1.75.

Potato Digging Fork. 6 tine, \$2.00.

Pruner, Standard Tree. Operated by a lever, to which the blade is connected by iron rod, 6-ft. pole, \$2.00; 8 ft. pole, \$2.25; 10-ft. pole, \$2.50; 12-ft. pole, \$2.75; 14-ft. pole, \$3.00; 16-ft. pole, \$3.50 each. Extra blades, 25c each.

Pruner, Telephone Tree. Without pole. A pole of any length to suit requirements can be inserted in the socket. It is operated by a cord tied in the end of the lever. \$1.75 each. Extra blades, 25c each. Extra springs, 25c each.

Pump, Kinney's Atomizer. For use in greenhouses to distribute liquid fertilizer or to mix or temper hot and cold water under pressure. \$3.00 each.

Putty Bulb. For glazing greenhouse sash. \$1.50 each.

Putty, Twemlow's Old English Glazing. A superior article for bedding glass in sash or filling cracks or seams in roof joints, etc. 1 gal., \$2.75; 5 gals., \$12.50.

Raffia. The best material for tying. Soft, pliable and strong. 40c per lb.

Raffia, Green. For tying plants, etc., \$1.25 per lb. pkg.

Rakes, Bamboo. Reinforced. Fan shape, 18 in., 65c; 24 in., \$1.00; 30 in., \$1.25, each.

Rakes, Brume. Steel, fan-shaped rake; used as a broom; strong and durable. \$1.25 each.

Rakes, Hay, Wood. Extra quality, three bow. \$1.00 each.

Rakes, Lawn, Wood. Extra quality. Three bow. \$1.25 each.

Rakes, "Lawncomb." New socket pattern. 24 tooth. \$1.25 each.

Rakes, Gumsinger Lawn Rubber. The teeth are live, resilient rubber, stiff enough to rake clean, but flexible enough not to tear or uproot the grass. Rakes clean over rough surface. The rubber teeth adjust themselves to every irregularity in the ground. Light and easily handled. No risk of injury if rake is left with prongs turned upright. Made in three sizes: 16 in. \$1.00, 20 in. \$1.25, 24 in. \$1.50.

Rakes, Steel Garden. Long teeth. 10 teeth, \$1.00; 12 teeth, \$1.15; 14 teeth, \$1.25; 16 teeth, \$1.35; 18 teeth, \$1.50.

Rakes, Steel Lawn. Short teeth. 12 teeth, \$1.25; 14 teeth, \$1.40; 16 teeth, \$1.50; 18 teeth, \$1.65.

Rope, Columbian Tape-marked. Pure manilla. "The guaranteed rope." In various sizes. Market price.

Sash, Hotbed. Well made from thoroughly seasoned lumber and glazed with double thick glass. Frame 1¼ in. 3x6 ft., \$6.50 each. Crating extra at cost.

Saws, Cross Cut, Two Man. Filed and set, ready for use. 5 ft. \$4.00 each. Handles, 50c per pair.

Saws, Cross Cut, One Man. With supplementary handles. 3 ft., \$3.50; 3½ ft., \$4.00 each.

Saws, Pole Pruning. \$2.00 to \$3.50.

Saws, Pruning. Single and double edge. Extra refined spring steel. 18 in., \$1.75; 20 in., \$2.00 each.

Saws, Wood (Buck). Complete, \$2.00 each.

Scissors, Flower. For cutting and holding flowers. 7 in. \$2.00 each.

Scissors, Grape or Vine. For thinning the bunch. Nickel-plated. 7 in., \$2.00 each.

Scoops, Coal. Extra quality. No. 2, \$2.00; No. 3, \$2.25; No. 4, \$2.50; No. 5, \$2.75; No. 6, \$3.00 each.

Scythes, "Witherell's" Finest Cutlery Steel. Fully warranted. \$2.25 each.

Scythes, Broad English or Lawn. \$3.50 each.

Scythes, Heavy Bush. \$2.50 each.

Scythes, Weed or Bramble. \$2.50 each.

Scythes Snaths. \$2.00 each; bush, \$2.25.

Scythe Stones, Carborundum. 50c each.

Scythe Stones, English Round. Talacre, 40c each.

Scythe Stones, "Manchester." 20c each.

Seed Sower, "Caloon." Best machine for sowing broadcast, grass seed, oats, barley, etc. \$5.00 each.

Silkline (Smilax Thread). Spools 40c each, box of 8 spools, \$3.00.

Shears, Goodwin Grass. Polished and ground carbon steel blades; lacquered handles of cold rolled steel, shaped to fit the hand.

No. 10. Ball-bearing, 13½ in. over all, 4¼ in. cutting blade, each, \$1.50.

No. 20. Plain bearing. Junior size, 11½ in. over all; 4 in. cutting blade, each, \$1.00.



Branch or Lopping Shears

The Forester. (Three power.) Latest, and considered the cleanest, easiest and fastest cutting shear manufactured.

Price
No. 1. Cuts 1-inch diameter. Length 20 inches \$4.25
No. 2. Cuts 1½-inch diameter. Length 27 inches 5.50
No. 3. Cuts 2-inch diameter. Length 34 inches 7.00

Shears, Grass Border. Long handle, 8 in. blade, \$6.00; 9 in., \$6.50; 10 in. \$7.00 each. Long handle wheel, 9 in. blade, \$7.00 each.

Shears, Grass or Sheep. \$1.00. English extra quality, \$2.50.

Shears, Hedge or Grass. English pruning notch. 8 in. blade, \$4.00; 9 in., \$4.25; 10 in., \$4.50 each.

Shears, Lawn or Grass. Long handle, 9 in., \$6.50 each.

Shears, Dahlia or Root. Imported. \$5.00 each.

Shears, Ladies' Hedge. American, 6 in. \$2.00. English, \$3.00.

Shears, Ladies, Pruning. 6 in. rose, \$2.00 each.

Shears, German Pruning. Nickel-plated, lock nut, volute spring. 8 in., \$3.00; 9 in., \$3.50; 10 in., \$4.00 each.

Shears, Pruning, French. With wheel spring, polished, 8 in., \$2.50; 9 in., \$3.00; 10 in., \$3.50. Extra springs, 50c.

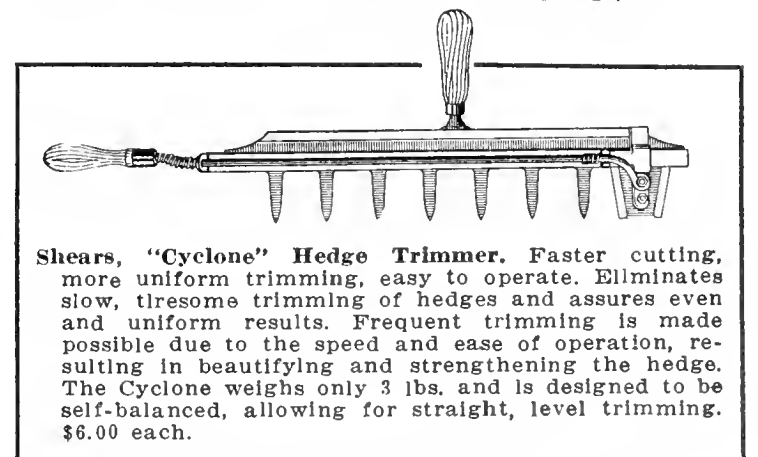

Shears, "Cyclone" Hedge Trimmer. Faster cutting, more uniform trimming, easy to operate. Eliminates slow, tiresome trimming of hedges and assures even and uniform results. Frequent trimming is made possible due to the speed and ease of operation, resulting in beautifying and strengthening the hedge. The Cyclone weighs only 3 lbs. and is designed to be self-balanced, allowing for straight, level trimming. \$6.00 each.

Shovels, Genuine English "Never Bend." Polished. Long or short handle, round point. \$2.50 each.

Shovels, Superior Steel. Round or square pointed D or long handle. No. 2, \$2.25 each; No. 3, \$2.50 each.

Shovels, Market Gardeners'. Light weight for banking Celery, etc. Long handle, \$1.75 each.

Sod Lifter. Useful for cutting under sod as it is being rolled. English, \$8.00; American, \$3.50.

Spades, Superior Steel. Extra quality. Either D or long handle. No. 2, \$2.25 each. English, \$2.50 each.

Stake Fasteners. Galvanized, rustproof wire. Hold the stakes and cross wires firmly.

Eureka. Small and light. Pkg. of 1000, \$3.00.

Everlasting. Heavy and strong. Pkg. of 1000, \$4.50.

Wire Plant Ties. Pkg. of 1000, \$2.50.

Stakes, Japanese Bamboo Garden. Very strong and durable ½ to ¾ in. in diameter. 4 ft., 50c per doz., \$4.00 per 100. 6 ft., 75c per doz., \$5.50 per 100. 8 ft., \$1.00 per doz., \$7.00 per 100.

Farm, Garden and Lawn Requisites, Tools, Etc.

Stakes, Japanese Cane, Green. Small and inconspicuous, but strong and useful for plants.

Doz. 100 1000			Doz. 100 1000		
1 1/2 ft. ..	\$0.12	\$0.50 \$2.50	3 1/2 ft. ..	\$0.25	\$1.00 \$ 6.50
2 ft. ..	.15	.65 3.25	4 ft. .	.30	1.25 8.00
2 1/2 ft. ..	.18	.75 4.50	5 ft. .	.35	1.50 10.00
3 ft. ..	.20	.90 5.50	6 ft. .	.40	2.00 15.00
6 ft., plain, 40c per doz., \$1.75 per 100, \$14.00 per 1000					
8 ft. plain, 50c per doz., \$2.50 per 100, \$22.00 per 1000.					

ADJUSTO PLANT SUPPORTS

Unexcelled for Tomatoes, Dahlias, Delphiniums, Hollyhocks, Etc.

Consists of a sturdy 3/8 in. square stake, pointed at one end, stained green and equipped with a strong, green enameled spring wire loop, adjustable to any height with growth of plants. Adjusto Supports are usable for years. Prices: 3 ft. height, \$2.50 per doz.; 4 ft. height, \$2.75 per doz.; 5 ft. height, \$3.00 per doz.; 6 ft. height, \$3.25 per doz.

Stakes, Garden, Painted Green. For house, greenhouse, and conservatory.

Light Round Stakes

Ft.		Doz.		100		Ft.		Doz.		100	
1 1/2	\$0.30		\$2.25		3 1/2	\$1.25		\$ 8.50	
250		3.50		4	1.50		11.00	
2 1/270		5.00		5	2.25		16.00	
3	1.00		7.00							

Heavy Round Stakes

Ft.		Doz.		100		Ft.		Doz.		100	
3	\$1.75		\$12.00		5	\$2.50		\$18.00	
4	2.25		16.00		6	3.00		22.00	

Square Stakes

Ft.		Doz.		100		Ft.		Doz.		100	
1 1/2	\$0.25		\$1.50		5	\$2.00		\$14.00	
235		2.50		6	2.25		16.00	
2 1/250		3.50		4 Ex. heavy ..		2.00		14.00	
380		6.00		5 Ex. heavy ..		2.50		18.00	
3 1/2	1.10		8.00		6 Ex. heavy ..		3.00		22.00	
4	1.35		10.00							

Stakes, Square, Unpainted. Hardwood 100 1000
 28 inches long\$0.75 \$6.00
 36 inches long 1.00 8.00
 48 inches long 1.25 10.00

Sticks, Match. Pine, 5-32 inch thick. Green. 50c per 100, \$4.00 per 1000.

Styptic, Thompson's (Imported). To prevent the bleeding of grape vines. Small bottle \$1.50, large \$2.00.

Tamper. Dirt and sod, high grade. 8x8 base. \$2.00 each.

The New Weed Puller. Out-U-Kum. Guaranteed to remove the root with the weed. A slight push and a pull does the trick. Price 75c each.

Thermometers, Wilder's. Japanned tin case, convex scale. 6 in., 75c; 8 in., \$1.00; 10 in., \$1.25.

Thermometers, Wilder's. Japanned tin case, heavy, 8 in., \$1.40; 10 in., \$1.50; 12 in., \$1.75.

Thermometers, Standard, Hothead. Boxwood, \$3.00.

Tinfoil. For bouquets, etc. 30c per lb; green, 50c per lb.

Tree Scrapers. \$1.25 each.

Trellises. Not carried in stock, but can be shipped promptly from factory. If crating is required in shipment, it will be charged at cost. Sizes 1 1/2 ft. to 12 ft. Prices on application.

Trellis, Tomato. Two hoop; 20c each, \$2.25 per doz.

Trellis, Tomato, Handy Vine. Made of wood and wire. 35c each, \$3.50 per doz.

Trowels, Garden, English Genuine. 6 in., \$1.00; 7 in., \$1.25.

Trowels, Garden, English Solid Stainless Steel. \$2.00 each.

Trowels, Transplanting. 6 in. 20c; 7 in. 25c each.

Trowels, Pointing. 4 1/2 in. 50c each.

Trowels, Flat, Steel. Best steel, 7 in. \$2.00 each.

Trowel, Garden. Extra forged steel. Solid steel blade and shank. 6 in. 75c; 7 in. 85c, each.

Truck and Leaf Rack, with 3 1/2-in. tires, \$35.00.

Truck and Hand Cart Box, with 3 1/2-in. tires, \$28.00.

Extra Barrels with Trunnions, \$6.50; extra trunnions, \$1.00 a pair.

Leaf Rack only, \$14.00; Hand Cart Box only, \$6.00.

Twine, Green Linen. For Smilax, 40c per ball.

Twine, Green Cotton. 20c per ball, \$2.00 per doz.

Twine, Hard. "For tying parcels," Heavy, medium and light. 50c per ball, \$5.50 per doz.

Twine, Soft. 2-, 3-, or 5-ply jute. 25c per ball.

Twine, Tarred Marline. Twisted. In 5-lb. and 10-lb. balls. Each 60c per lb.

Twine, Tarred Yarn (Lathyrn). Excellent for tying shrubs, etc., 35c per lb.

Twine, White Cotton. 20c per ball, \$2.00 per doz.

Twine, Yacht Marline. In 1/2-lb. balls, 50c each.

Watering Pots. Galvanized iron detachable rose watering pot. 4-qt., 85c; 6-qt., \$1.00; 8-qt., \$1.15; 10-qt., \$1.25; 12-qt., \$1.50.

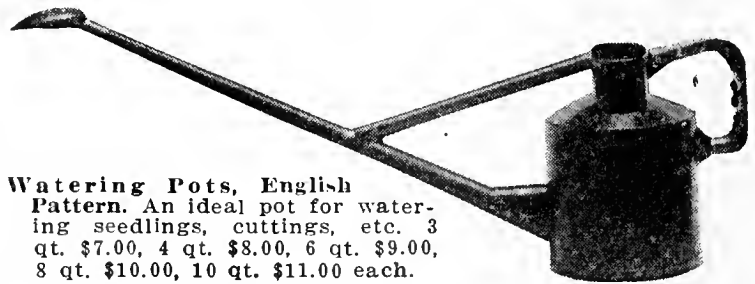

Watering Pots, English Pattern.

An ideal pot for watering seedlings, cuttings, etc. 3 qt. \$7.00, 4 qt. \$8.00, 6 qt. \$9.00, 8 qt. \$10.00, 10 qt. \$11.00 each.

Watering Pots, Galvanized Iron. The best watering pot made, for strength, durability and neatness. Made from best quality iron; the top and back handles riveted on; an iron band on the bottom; the spout riveted, and a brace around it riveted to the body, and galvanized after it is made. A coarse and fine copper-faced rose with each pot.

Extra rose 75c.	Each
4 qts., spout 18 in. long	\$5.50
6 qts., spout 21 in. long	6.00
8 qts., spout 23 in. long	6.50
10 qts., spout 25 in. long	7.00
12 qts., spout 25 in. long	8.00
16 qts., spout 25 in. long	9.00

Watering Pots, French Pattern. Made of galvanized iron; oval in shape, with brass handle and long spout; one fine and one coarse copper-faced rose with each. 6 qt. \$7.00, 8 qt. \$7.50, 10 qt., \$8.00, 12 qt. \$8.50 each.

Wedges. Truckee pattern, solid cast steel. 15c per lb.

Weeders, Baby Warren Hoe. 50c each.

Weeder, Magic. Hand, 3-tine, 18 in. handle, 25c each; 30-in. handle, 40c each; 4-tine, heavy 42-in. handle, \$1.00 each.

Weeder, Onion. Triangle-shaped, 8 in. handle, 3 in. blade, 40c each; 4 ft. handle, 3 in. blade, 75c.

Weeder, Three-pronged. 60c each. Long handle, \$1.00.

Weeder, Excelsior. 20c each.

Weeder, Hazeltine. Steel blade, with wooden handle. 35c each.

Wires, Annealed galvanized. No. 14, \$1.50; No. 16, \$1.75; No. 18, \$2.00; No. 20, \$2.25 per stone of 12 lbs., in coils.

Wrenches, Monkey. Knife handle. 6 in., \$1.00 each; 8 in., \$1.25 each; 10 in., \$1.50 each; 12 in., \$2.00 each; 15 in., \$2.50 each.

Wrenches, Stillson. Length when opened, 6 in., 75c each; 8 in., \$1.00 each; 10 in., \$1.25 each; 14 in. \$1.50 each; 18 in., \$2.00 each; 24 in., \$3.00 each.

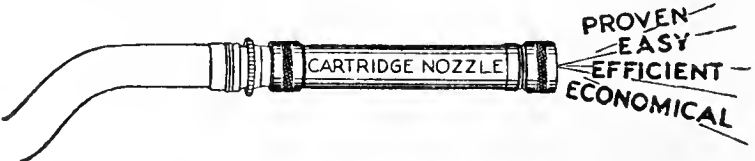

Antipestick - Foodndrink - Nodew

Antipestick Cartridge for control of plant pests, thrips, aphid, green flies, plant lice, etc. 35c each.

Foodndrink Cartridge. A balanced plant food for lawns and plants. 5c each; 30 for \$1.00.

Nodew Cartridge for control of mildew, rust, black spot, fungous diseases, red spiders and ants. 25c each.

Brass Container Nozzle, \$1.00. Extension spray elbow (for spraying under the leaves), 75c. Shutoff, \$1.25.

Grey's Approved Sprayers for Insecticides and Fungicides

Smith Wheelbarrow Sprayer

With or Without High Pressure Tank

For use in spraying orchards, garden truck, etc.; also for spraying whitewash, cold water paints, disinfectants and for general spraying purposes. Exceptionally well built for long, hard service. All working parts are brass. The high pressure air tank, guaranteed for 50 lbs. pressure, will spray for a considerable length of time after the pressure has been pumped up. The extra large wheel permits easy wheeling. The pump is very powerful.

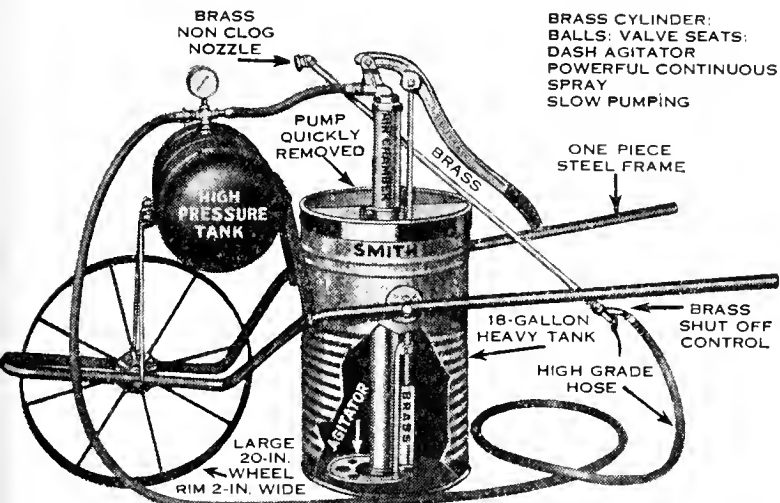

No. 60PG—Complete, with High Pressure Tank and 18-gallon Galvanized Bucket. Price, \$35.00.

No. 60G—Complete, with 18-gallon Galvanized Bucket, but without High Pressure Tank. Price, \$25.00.

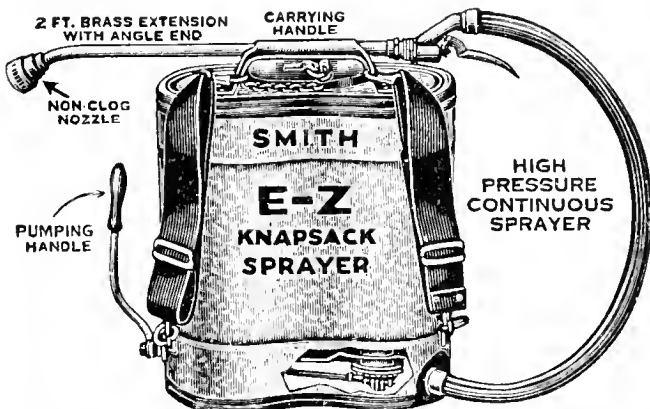

The latest for spraying all truck and field crops, fruit trees, shrubs, flowers, etc. Easily operated when in position on carrier's back. Has large diaphragm pump for high pressure and continuous even spray.

Specifications

Tank. 4-gallon capacity, kidney-shaped to fit back. Copper bearing galvanized steel or solid copper. Large brass filler opening with removable brass strainer.

Air Chamber and Valves. Large capacity for continuous high pressure. Valves specially compounded rubber seating on machine brass valve seat and easily removed if desired.

Hose Section. 3 feet best grade hose equipped with cast automatic shutoff. 2 foot seamless brass, angle end extension pipe which is removable if desired.

Nozzle. Heavy brass. Non-clog.

No. E-Z-B-Knapsack Sprayer, complete with solid copper tank, \$18.50.

No. E-Z-G-Knapsack Sprayer, complete with galvanized steel tank, \$12.50.

Spraymaster

Two-Quart Galvanized Tank—Twin Nozzle Continuous Sprayer. A rapid worker. Price, \$1.75.

BANNER COMPRESSED AIR SPRAYER

None Better for the Medium Sized Garden or Small Orchard

The tank is made of heavy solid copper, or heavy galvanized steel, double seamed and well riveted, to stand heavy pressure. Tank has double bottom.

For use in Spraying Orchards, Flower and Vegetable Gardens, and Vineyards.

Pump, heavy seamless brass with cast brass pump head. A few strokes of the pump charges the tank with compressed air, and by releasing the lever control spray pours forth in a fine broad mist, or long distance spray according to the adjustment of nozzle.

Hose. 2 feet of best grade, with coil spring to prevent breaking when not in use, and in addition a brass rod 2 feet long with swivel joint to allow easy spraying underneath leaves or at any angle.

Nozzle, automatic, non-clog.

Banner Sprayer, Copper tank with Funnel Top. Capacity 4 gallons. \$9.75.

Banner Sprayer, Galvanized tank with Funnel Top. Capacity 4 gallons. \$6.50.

Justrite, 2½-gal. Brass tank. \$6.00.

Justrite, 2½-gal. Galvanized tank. \$4.00.

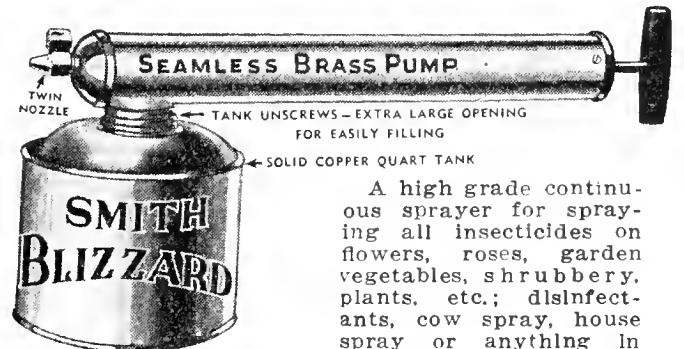
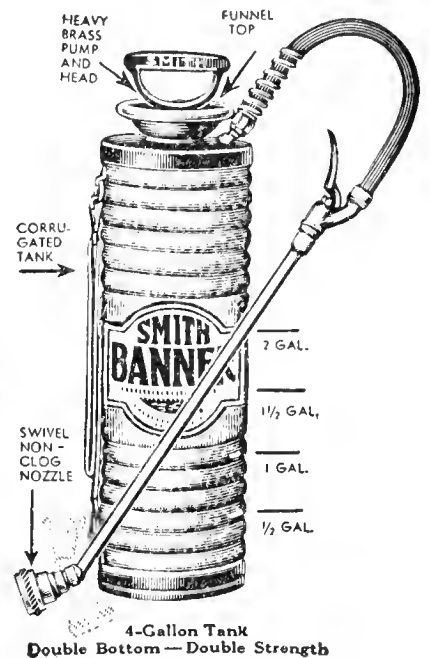

CONTINUOUS SPRAYER

The SAVOL sprays insecticides on flowers, garden vegetables, shrubbery, plants. Disinfectants, fly sprays, cattle fly oil, etc. Sprays lacquer, stains, etc., on house and porch furniture, automobiles, etc. Price \$1.25.

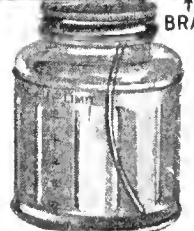

Sturdy Spray Pump

Made Entirely of Brass.

Double Action—Continuous Unbroken Spray

Sprays All Insecticides, Disinfectants and Whitewash
Used with pail, bucket, or barrel by simply placing bucket strainer in such vessel. It works with ease on the up-and-down stroke. One brass tube works inside the other. It will spray the tallest tree from the ground.

Tank—5 gal. galvanized steel, as ordered. Complete with carrying straps.
Price, complete, \$10.00. Pump only, \$5.00.

Grey's Approved Dusters

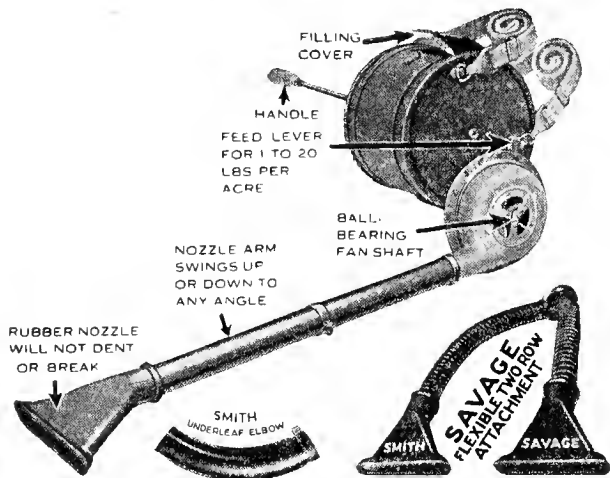

"Savage Duster." Handles everything in powdered form; a high grade, well-built duster made to stand long, hard service. Highly adapted for spraying garden, vegetables, shrubbery, plants, etc. It is free running and easy cranking. has no brushes or wipers. Bronze and steel gears packed in grease, sealed-in gear case; never requires any attention, fan shaft runs on ball bearings. Under-leaf elbow for dusting under side of vines, connects between pipe and nozzle, is furnished without extra cost. Price complete, \$22.00. Two-row attachment, connects to dust pipe for dusting two rows with one passing, furnished complete with two rubber nozzles. Price \$3.50.

NO. 17 DUST KING POWDER DUSTER
A Powerful, Smooth Operating, Low-Priced One-Man Duster

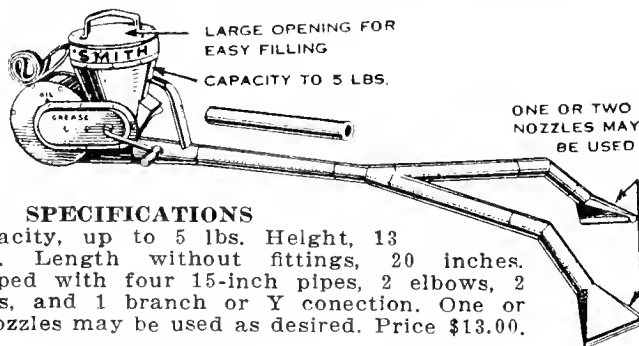

SPECIFICATIONS

Capacity, up to 5 lbs. Height, 13 inches. Length without fittings, 20 inches. Equipped with four 15-inch pipes, 2 elbows, 2 nozzles, and 1 branch or Y connection. One or two nozzles may be used as desired. Price \$13.00.

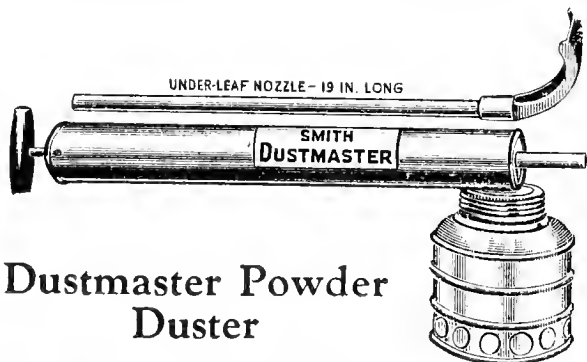

Dustmaster Powder Duster

A Splendid High-Grade Duster—Dusts Everything in Powdered Form—Built of the Finest Material and Made to Stand Long, Hard Service—Will Dust Under Side of Leaves or at Any Angle \$1.25 each.



The Double Barrel Duster. For spraying all dry insecticides. 75c each.

Hand Garden Tools and Seeders

NO. 301 DOUBLE AND SINGLE WHEEL HOE.

In cultivating onions, beets, turnips, radishes, etc., it is invaluable; saves hours of hard labor. One great advantage which this double wheel hoe possesses is that it can be made into a single wheel hoe in a moment's time. An axle is sent with every double wheel hoe for this purpose. The wheels are 16 inches high. Price \$10.00.

No. 303. The same tool as 301 without vine lifters, cultivator teeth or plows. Side hoes only, \$8.00.

No. 313. The same tool as 301 without plows or vine lifters. Side hoes and four cultivator teeth only. \$9.00.

THE NEW MODEL SEED DRILL

This we consider the simplest and best drill on the market. The diamond-shaped adjustable hole regulates the discharge, and can be made larger or smaller as occasion requires. It has a broad wheel and a covering roller. The opening plow is adjustable in depth. Price \$14.00.

NO. 19C SINGLE WHEEL CULTIVATOR AND PLOW

The distinctive feature of this tool is the high steel wheel measuring 24 inches with landside plow, scuffle hoe and cultivator teeth, complete, \$5.50.

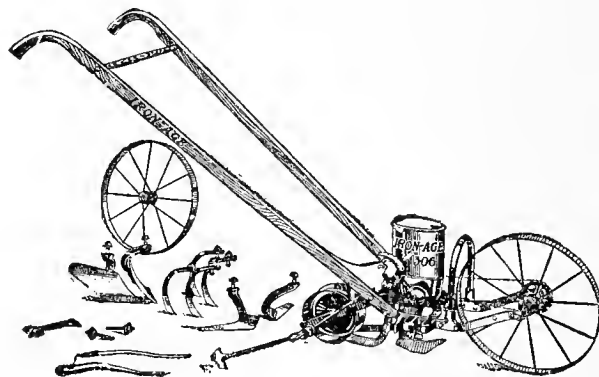

NO. 306 COMBINED HILL AND DRILL SEEDER DOUBLE AND SINGLE WHEEL HOE

Many men should use combination tools for two reasons: They save in first cost and they take up less room.

Thousands of gardeners have found this to be true of No. 306. Complete \$20.00.

OHIO SINGLE WHEEL HOE and CULTIVATOR. Complete with 1 set of 5 cultivator teeth and 1 pair side hoes. Price \$4.00.

Jim Dandy Sprayer

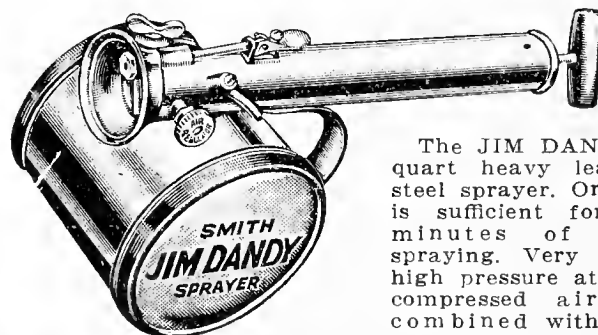

The JIM DANDY is a 3-quart heavy leaded sheet steel sprayer. One pumping is sufficient for several minutes of continuous spraying. Very powerful, high pressure atomizer and compressed air sprayer combined with automatic shut-off. For spraying flowers, roses, vines, shrubs, small trees, garden vegetables. Has air regulator valve for obtaining coarse spray or fog mist, light or heavy as desired. Price \$3.50.

PRICES. ALL PRICES ARE NET WITHOUT DISCOUNT AND SUBJECT TO CHANGE WITHOUT NOTICE.

THE NEW NORCROSS GARDEN GROWER

It Flows—It Weeds—It Cultivates—It Mulches

Positively banishes the back-breaking drudgery and work of garden planting, weeding, cultivating, and mulching, by performing these operations in a quick, easy way, without bending, kneeling, stooping, pulling, tugging or hand hoeing.

Simple to Operate—Well Made

Advantages—Destroys weeds that infest the garden and rob plants of moisture and nutriment—rids gardens of injurious insects attracted by weeds—keeps soil mellow and increases garden yield—works in all kinds of soil. Leaf guards permit all-season use by protecting large or overhanging leaves from wheel movement.

Complete as illustrated. Made in two sizes:

- No. 8—8 in. wide. Price complete\$6.50
- No. 10—10 in. wide. Price complete 7.50

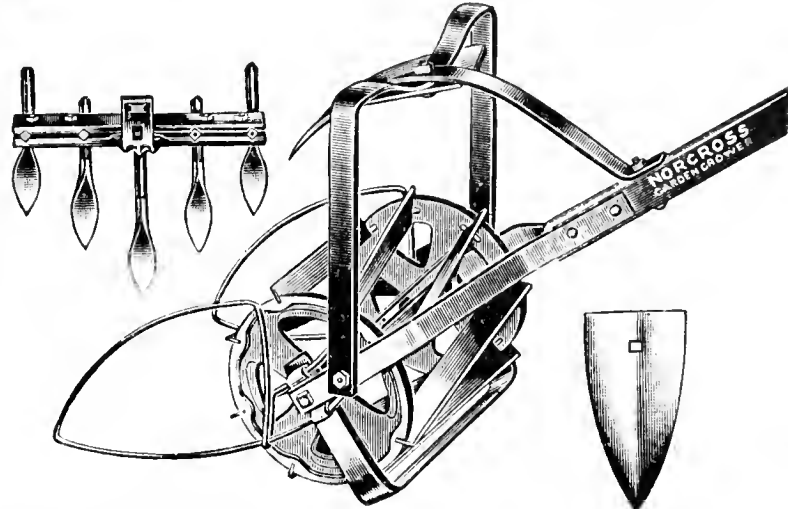

COLDWELL — LAWN MOWERS — MOTOR

COLDWELL CUB

21-inch Cut. Capacity Two to Three Acres Per Day.

SIXTEEN SPECIAL FEATURES

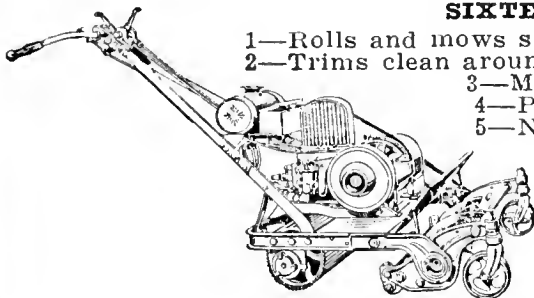

- 1—Rolls and mows simultaneously.
- 2—Trims clean around trees, shrubbery, along walks, etc.
- 3—Machine may be used for rolling only.
- 4—Produces a smooth, velvety turf.
- 5—Negotiates grades with ease.
- 6—Simple and economical to operate.
- 7—Extremely flexible for trimming.
- 8—Full width, two-section drive roller.
- 9—Norman Hoffman self-aligning ball bearings.
- 10—Three speed control.

- 11—Simple, powerful four cycle water cooled motor.
- 12—Engine automatically lubricated.
- 13—Alemite-Zerk force-feed lubrication.
- 14—Clutches and transmission entirely enclosed.
- 15—Spring loaded clutches require no adjusting and release automatically.
- 16—Entire machine, including the motor, designed and built by Coldwell.

Weight net, 260 lbs. Price, \$190.00, f. o. b. factory.

THE NEW SUPER TWIN CYLINDER LINE

25-inch and 30-inch Cut.

Suitable for lawns of from four to eight acres, also for baseball parks and athletic fields. Extreme flexibility for trimming and for terrace work. Equipped with two cylinder, four cycle water cooled motor, which provides an abundance of reserve power. Is free from vibration and noise and will develop maximum power continuously in hot weather without overheating. Full width, two-section drive roller with differential between the rollers to prevent marring and to make turning easy. Riding sulky for the operator, and grass catcher may be had as extra equipment.

SUPER "L TWIN"—25-inch cut, 4 to 6 acres per day. Weight net, 362 lbs. Price, \$325.00, f. o. b. factory.

This model may also be furnished with two 20-inch auxiliary gang units, which more than double the cutting capacity. These units may be attached or detached in a moment.

SUPER "L TWIN" WITH GANG—60-inch cut, 10 to 12 acres per day. Price, \$385.00, f. o. b. factory.

SUPER "TWIN 30"—30-inch cut, 6 to 8 acres per day. Weight net, 420 lbs. Price, \$375.00, f. o. b. factory.

Side View Illustration Super Twin "60" With Two Gangs and Riding Sulky.

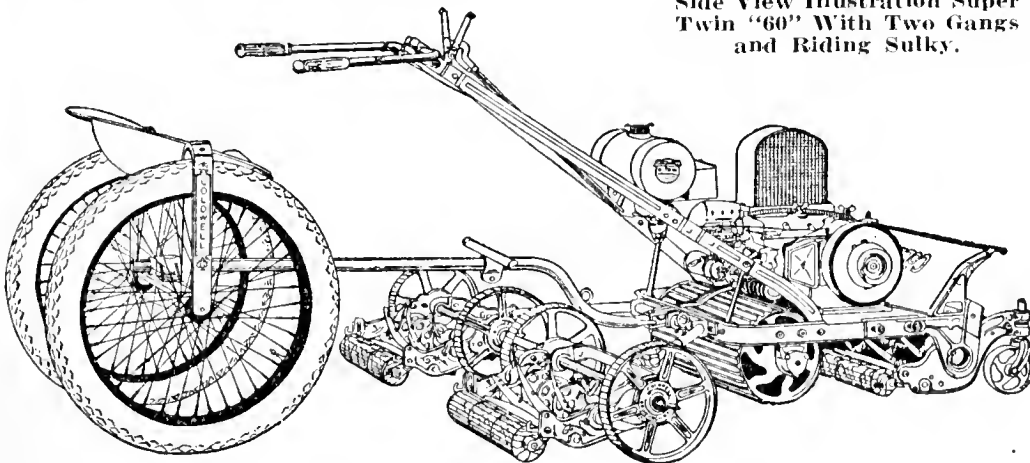

"Coldwell's Red Top"

New wheel type, 21-inch power lawn mower (not illustrated). This mower has the same type engine as is on the Cub, with the exception that it has a throttle control instead of a governor control. The clutches are the regular flat disc type, one for the revolving cutter and one for the drive wheels. It has a 5-blade revolving cutter. The wheel section is built with a differential, which will permit the mower to turn easily and without digging up the lawn. Price, \$150.00, f. o. b. factory.

We also have this mower equipped with pneumatic tires, namely, the "Red Top De Luxe," price \$164.50, f. o. b. factory.

Owing to limited space, we cannot fully describe these machines in our catalog, but will gladly mail a descriptive circular upon request.

LAWN MOWERS—HAND

AMBASSADOR DE LUXE. Coldwell's latest high grade quality lawn mower with modern improvements. It is quiet and easy running. Especially useful as a general all-purpose machine for well-kept lawns and requires minimum attention. Very popular mower among gardeners and for parks and cemeteries. Is equipped with 10-in. diameter wheels with pneumatic tires carried on roller bearings, adjustable for end play. Guard roller is rubber covered and carried on ball bearings mounted in roller hanger. Revolving cutter is 5-blade, equipped with Norma-Hoffman ball bearings. 14 in., \$18.00; 16 in., \$20.00; 18 in., \$22.00.

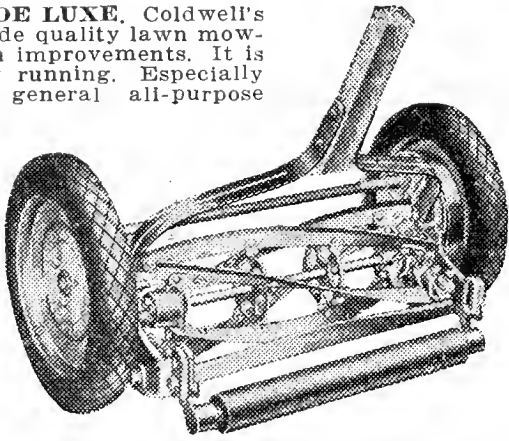

COLDWELL IMPERIAL. 5-blade, high wheel, equipped with improved Norma-Hoffman self-aligning ball-bearings. For use in cemeteries, parks, and private estates, where they are expected to do heavy work. 16 in., \$18.00 each; 18 in., \$20.00 each.

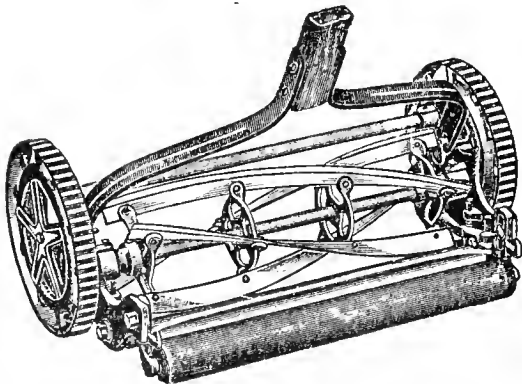
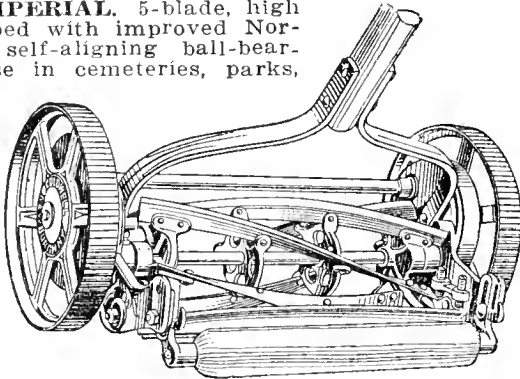

COLDWELL CRUSADER (BALL BEARING). A light-weight, 5-blade mower, designed to meet the demand for a machine of lighter construction at a moderate price. 14-in., \$6.50 each; 16 in., \$7.00 each; 18 in., \$7.50 each.

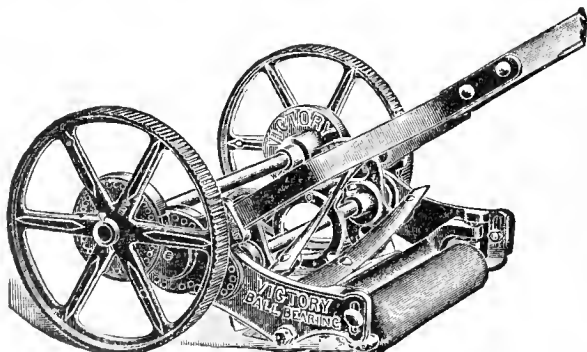

VICTORY BALL-BEARING LAWN MOWER. 10 in. wheel, 4-bladed reel, (triple gear), easily run and almost silent. 14 in. \$15.00, 16 in. \$17.00, 18 in. \$19.00, 20 in. \$21.00.



OHIO REVERSIBLE PUSH-PULL LAWN MOWER. An entirely new principle in lawn mower design. It cuts when you push; it cuts when you pull. It is a forward type cutting lawn mower with flexible ground bar and reel hung in front of center, instead of rear. It will cut close to any object. Can be pulled instead of pushed by reversing handle. With handle reversed, it is specially adapted for terrace cutting or for trimming under bushes, without injury to foliage. Can be adjusted in a fraction of a second to cut grass extremely high or very low. It has 10 in. drive wheel and 5-blade revolving cutter. 16 in., \$20.00 each; 18 in., \$22.00 each.

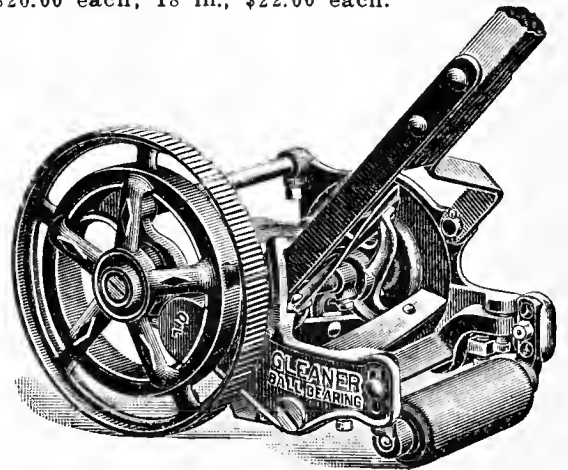

TOWNSEND'S "GLEANER" BALL BEARING. Strong, light and powerful. Only 1/8 in. of metal between ends of blades and any obstruction to be cut around. 9-in. wheel, 4 blades. Width of cut 8 in., \$9.00 each; 10 in., \$10.00 each.

GRASS CATCHERS. Will fit any style of lawn mower. 14 in. and 16 in. \$1.50 each; 18 in. and 20 in. \$2.00 each.

Lawn Mower Service Department

This department, which we have featured for many years, is located in our building, and operated by skilled mechanics.

With its improved facilities for resharpener, repairing, and adjusting hand, horse, and motor mowers, we solicit your patronage. To insure seasonable delivery, early shipments are suggested. Please note what you especially wish done to your mower, on the tag or by letter. In cases where this is omitted, we will sharpen same and put in perfect condition.

**Model G
Rain King**

Throws any known kind of spray over circle 12 to 65 feet on normal pressure. A quarter of a turn of the nozzle gives you any kind of a close-in or far-out spray you want. This utterly new type sprinkler can be set to revolve very slowly for good soaking downpour without stalling even in high wind, on slopes, etc., or faster, if desired, for light spray on flowers, seeded beds, etc. New disc type, easy to move base. Simple, strong, it will last a life-time. Rich and distinctive in appearance. Brass arm, upright and nozzle mounted on rich green enamel base. Price, \$3.50 each.



Lawn Sprinklers

**Model E
Rain King**

For golf courses, estates, parks, etc. This Model E has a spinning vibrator that prevents stalling even on hillsides or in high winds. Here is a sprinkler that, at any given pressure, will throw more water, and throw it farther than any other sprinkler we know of. It spreads the water evenly throughout the entire watered area. Quickly set for fast or slow turning. Beautiful in appearance, sturdily built, and will last and perform well for many a year. Price, \$17.50.

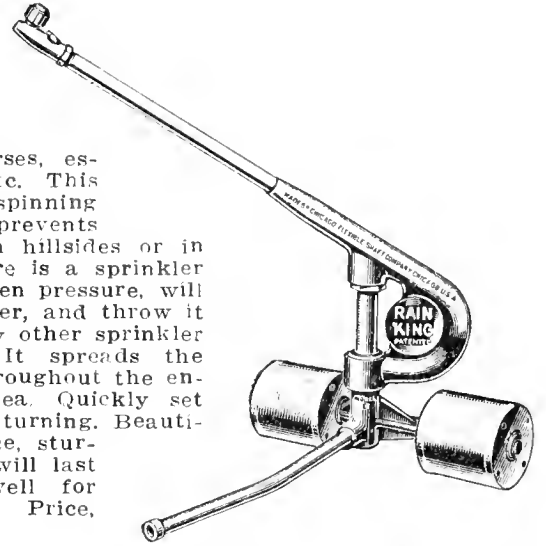

Rain Wave

The Rain Wave sprinkler embodies the Skinner System principles of watering. Covers about 60 feet by 60 feet, with 35 pounds pressure. Beautiful in operation. Built for many years service. Very popular with private estates and golf clubs. Circular on request. Price, \$37.50.

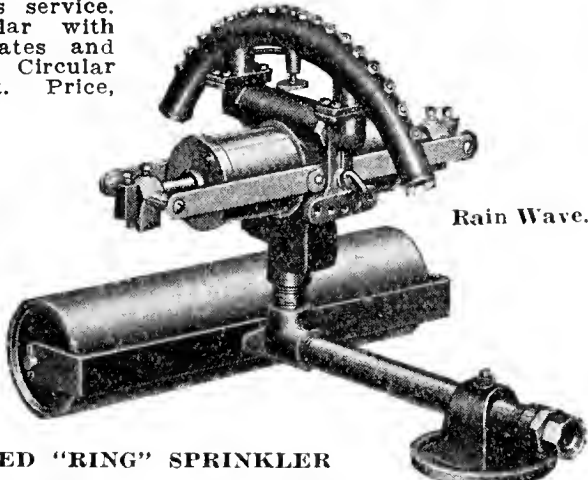

Rain Wave.

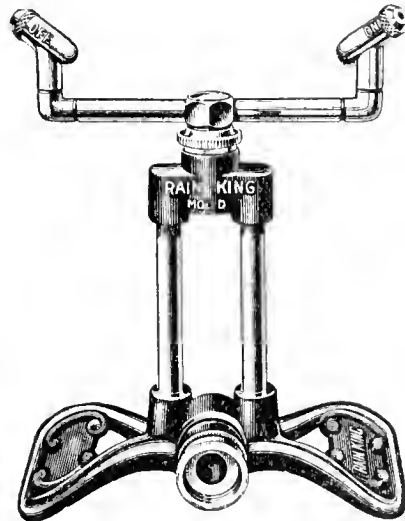

**Model D
Rain King**

The latest Rain King. Most beautiful in appearance and exceptionally efficient on all water pressures or any spray. Fitted with latest patent Rain King nozzles which require just a touch to adjust for any spray or direction. Has double brass water column, wide spread base with exceptionally easy hose coupling. Finish, red and brass; height, 9 inches. Price, \$2.00 each.

IMPROVED "RING" SPRINKLER

Heaviest all-brass ring sprinkler on the market. Waters circle 30 to 40 feet in diameter. Price \$1.00 each.

Frog Sprinkler

A realistic appearing ornamental lawn sprinkler that throws a spray 4 inches high and 4 1/2 inches wide. Finished in green with black spots and white throat. Ornamental for rock gardens. Price, \$1.00 each.

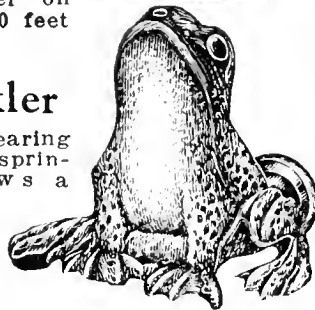

**Water Ballast
Lawn Roller**

Adapted for rolling lawns, golf courses and tennis courts. Light running, round edge. No tearing up of sod. Scraper to keep surface clean.

Roller bearings in the following sizes:

No.	Diam. Inches	Length Inches	Weight Empty	Weight Filled with Water	Price
602	18	24	85	265	\$17.00
603	24	24	110	420	20.00
604	24	32	130	566	23.00

Plain bearings in the three sizes below.

605	14	24	68	175	12.00
606	18	24	82	265	14.00
607	14	15	50	115	11.00

RIP SPRINKLER

"The Master Rainmaker"

A self adjusting, simple, and economical lawn sprinkler; will not clog or corrode.

Just stick the spike in the ground, turn on the water and see the 150-foot (60 ft. diameter) circle of perfect Raindrops. Will operate efficiently on as low as 5 pounds pressure.

Three Types

No. 1 Spike and No. 2 Irrigation. 75c each. Connection type No. 3. \$1.00 each.

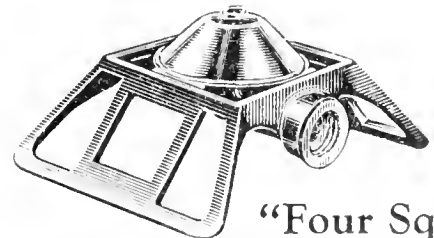

"Four Square"

This new sprinkler fits in with today's economy trend. Sprinkles SQUARE AREAS (about 13 by 18 feet with normal water pressure), eliminating waste, as it is not necessary to resprinkle, where circle sprinkling overlaps. A fine spray is thoroughly and evenly distributed. This sprinkler has a cast iron base and the top is polished stamped sheet brass. Height, 3 1/4 inches. Price, \$1.00 each.



Farm and Garden Tools and Implements

We carry in stock Cultivators, Harrows, Planters, Seeders, Hoes, Mowers, Rakes, and Tedders, some of which are described and illustrated herein. Circulars fully describing our various implements will be mailed upon request.

CULTIVATOR, McCORMICK-DEERING

McCormick-Deering 1-horse cultivators can be supplied in 5-, 7-, and 9-shovel and 14-tooth, with a variety of special equipment that adapts them to the needs of those sections where the work is done with one horse. For the cultivation of all farm and garden crops. Prices on application.

HARROW, McCORMICK-DEERING, SPRING TOOTH, WITH LEVERS

9-tooth, 1-horse, with handles, weight 126 lbs. \$18.00
 15-tooth, 2-horse, two sections, weight 210 lbs. 25.00
 17-tooth, 2- or 3-horse, two sections, weight 228 lbs.. 27.00
 Sulky attachment for 15- and 17-tooth Harrows 13.50

HARROW, McCORMICK-DEERING DISC
 made with a much stronger frame than the ordinary type disc harrow, being made of a heavy angle steel cross-bar to which draft links are fastened. Made with either solid cutaway discs. It is made in different sizes for horses or tractors. Can be supplied with fore carriage and transportation trucks or separate if desired. Prices on application.

HARROW, McCORMICK-DEERING PEG-TOOTH

This harrow can be used with great success on stony ground. Teeth can be quickly set at any desired angle by the lever. One section, with evener, for one horse, \$12.00; two sections with evener, for two horses, \$23.00.

MEEKER SMOOTHING DISC HARROW

Designed especially for market gardeners' work. A perfect harrow and land-roller combined. The frame measures 6 ft. 8 in. by 6 ft., and has four sets of rollers, having 58 steel discs 8 in. diameter on them. The discs grind all the lumps so fine that the seed must come up, leveling and leaving the land fine and smooth and does its work far better than the rake. Price, \$40.00.

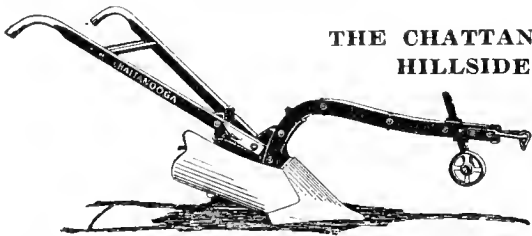

THE CHATTANOOGA STEEL HILLSIDE PLOW

They are the result of years of experiment and for strength, lightness and

ease of draft cannot be equaled; while intended for hillside work, will do equally as good work on level land.

No. 208. 1-horse plow with wheel \$16.00
 No. 209. 2-horse plow, complete with cutter or jointer 25.00

THE COMBINATION STEEL BEAM LANDSIDE PLOW

The latest and most up-to-date steel landside plows on the market. Furnished with jointers or cutters, as desired.
 No. 97. Regular 2-horse, complete \$30.00
 No. 100. Regular 2-horse, same as above, but with shorter beam. Specially adapted for stony ground.
 Complete 30.00

THE ORIGINAL 76 WOOD BEAM HILLSIDE PLOW

This pattern of the popular A. B. C. Series is of light weight and thoroughly constructed. Handles can be raised or lowered. Has automatic cutter, shifting lever clevis and a spring foot latch. Two sizes.

B. Regular 2-horse, complete with wheel and cutter \$25.00
 C. 1-horse, complete with wheel 16.00

THE ONE-HORSE WOOD BEAM PLOW

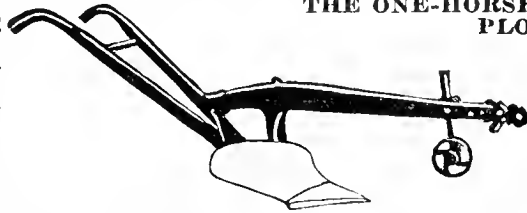

Beam adjustable so that the horse can walk on the land or in the furrow.

No. 52. Grey's Special. Regular 1-horse plow with wheel \$16.00

THE VINEYARD AND GARDEN PLOW

Chilled wearing parts. Horse can walk in the furrow or on the land. Handles can be adjusted sideways or up and down. Iron beam, 1-horse, with wheel, \$14.

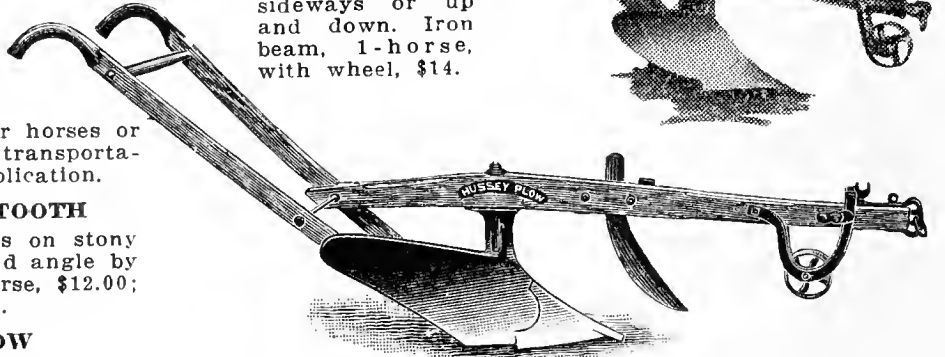
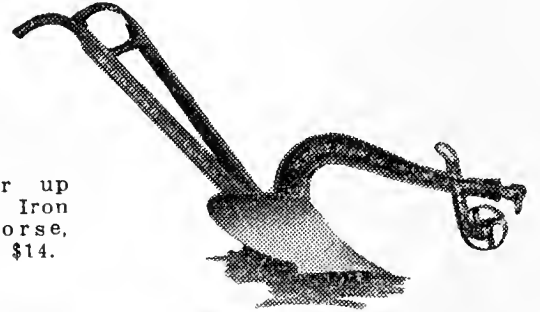

PLOWS, HUSSEY HARD METAL

No. 100. 1-horse. Furrow 5 to 6 in. deep, 10 in. wide. \$16.00
 No. 102. Light 2-horse. Furrow 5 to 7 in. deep, 12 in. wide 18.00
 No. 104. Medium Sward. Furrows 8 in. deep, 16 in. wide 24.00

AMERICAN STEEL DRAG SCRAPER

Our late addition of a steel drag scraper is of an improved pattern and made without seam or lap, pressed from a single plate of steel. The bowl is well rounded at the sides and curved upward to form the back. They are strong and substantial and made in three sizes. No. 1, 7 cu. ft., \$12.00; No. 2, 5 cu. ft., \$11.00.

7½-FT. HORSE WEEDER

By the use of weeders much time and labor are saved, and better crops grown. They will not cut the roots of the crop, but cultivate just deep enough to retain the moisture where it is most needed. Price, \$18.00.

THE SHOVEL POTATO HOE

It is made to meet the demands of large growers of potatoes, being designed both for hilling and covering purposes. Price, \$18.00.

KING OF THE CORNFIELD CORN PLANTER AND FERTILIZER DISTRIBUTOR COMBINED

For planting field or ensilage corn, beans, peas or beet seeds, in hills or drills with check. Price, \$42.00.

FERTILIZER SOWER, THE STEVENS' HAND

Does the work perfectly, sowing all kinds of lawn dressing and other commercial fertilizers, wood ashes, lime, etc., in large or very small quantities. Price \$25.00.

NORTHLAND STONE BOATS AND HEADS

Strongly bolted. Heavy woodwork; made in two sizes; 6 ft. by 29 in. and 7 ft. by 32 in. Heads are steel. The wood part is made from rock maple and the whole is thoroughly well bolted, making the very best pattern of stone boat in the market. The heads are equipped with a full set of bolts. Prices: 6-ft. boat, \$14.00; 7-ft. boat, \$20.00; heads alone with bolts, \$7.50.



Insecticides and Fungicides

Ant Trap "Tat." Destroys all species of ants. Trap contains two baits attracting both SWEET and GREASE eating ants. For house or garden. Metal container with non-fluid bait. Each 25c.

***Aphine.** For the destruction of the green, black and white fly, thrips, red spider, mealy bug, caterpillars, scale, etc. Qt. \$1.25, gal. \$3.50.

***Arsenate of Lead (Dry).** Lb. 25c, 5 lbs. \$1.00, 25 lbs. \$4.00.

***Black Leaf 40 (Sulphate of Nicotine).** A concentrated liquid for use in destroying green aphids and thrips. Oz. bottle 35c, 5 ozs. \$1.00, lb. \$2.25, 2 lbs. \$3.25, 5 lbs. \$5.85, 10 lbs. \$10.60.

***Bordeaux Mixture, Dry.** Can be used either dry as a dust or mixed with water as a spray for all fungous diseases. 1 lb. to 5 gals. of water. 1 lb. 25c, 4 lbs. 80c, 25 lbs. \$4.00.

Bye, Bye, Blackbird. A safe remedy for the user, but sure to rid cornfields of crows, blackbirds, etc. ½ pt. 65c, pt. \$1.00.

Carbola. A combined disinfectant, insecticide and cold water paint. Unexcelled as a whitewash. 5 lbs. 75c, 10 lbs. \$1.25, 25 lbs. \$2.75, 50 lbs. \$5.00.

***Copper, Ammoniated Solution of.** A liquid fungicide, ready for use. Dilute at the rate of 1 qt. to 25 gals. of water, and spray lightly. Qt. \$1.50, gal. \$4.60.

***Creosote, Gypsy Moth.** For the destruction of the eggs of gypsy moth. Qt. 50c, gal. \$1.25, 5 gals. \$5.00.

***Cyanogas (Calcium Cyanide).** "Grade A." Will destroy rats, ground hogs, etc. ½ lb. 45c, lb. 75c, 5 lbs. \$3.00.

Formacide. Formaldehyde Dust Triple Strength Seed and Soil Disinfectant. For control of damping-off. Full directions on request. ½ lb. 45c, 1 lb. 75c, 5 lbs. \$2.00.

Cyanogas (Grade G). Fumigant. 5 lbs. \$3.00, 25 lbs. \$10.00.

***Fungtrogen.** An effective and scientific preventive and remedy for mildew, black spot and many fungous diseases of Roses and other plants. Pt. \$1.25, qt. \$2.00, ½ gal. \$3.50, gal. \$6.00.

Grape Dust. For destroying mildew on grape vines and trees affected with mold, mildew or rust mites. 5-lb. pkg. \$1.50.

***Lemon Oil.** A safe and effective insecticide for all insects and soft scale, highly recommended for house plants. Qt. 85c, gal. \$2.50.

***Lime-Sulphur Solution.** Will completely destroy San Jose and other scale. Qt. 50c, gal. \$1.00, 5 gals. \$3.50, ½ barrel, about 30 gals., 50-gal. barrels, price on application.

***Lime and Sulphur, Dry.** For dormant spraying of fruit; used for same purposes as Liquid Lime-Sulphur, but is much easier to handle. 1 lb. 30c, 5 lbs. \$1.25, 10 lbs. \$2.00, 25 lbs. \$3.50.

Nico-Fume Tobacco Paper. (Registered). For fumigating greenhouses. Positively the strongest Tobacco Paper on the market. 24 sheets \$1.25, 144 sheets \$4.50, 288 sheets \$8.00.

Nico-Fume Powder. For fumigating. 5 lbs. \$3.35, 10 lbs. \$5.85.

Nico-Fume Pressure Fumigator. The new way. Much more effective than the old loose-piles method. ½-lb. can 45c, 1-lb. can 75c. Larger quantities price on application.

***Pomo-Green with Nicotine.** The Leaf Green All-in-one Dust or Spray. A single material used as a dust or spray; for all leaf-eating or sucking insects, and aphids. Also diseases on Roses, flowering plants and shrubs without being conspicuous on foliage. 1-lb. can 75c, 5-lb. can \$3.00.

***Pyrox, Bowker's, The New Improved.** The one best spray for all leaf-eating insects and fungous diseases. All ready to use by adding water. 1 lb. 50c, 5 lbs. \$1.75, 10 lbs. \$3.00, 25 lbs. \$5.00.

***Richard's X L All Liquid Insecticide.** Destroys mealy bug, red spider, etc. Qt. \$3.00, gal. \$10.50.

Scalecide. The most reliable and economical remedy for San Jose scale and all fungous diseases. Qt. 65c, gal. \$1.55, 5 gals. \$5.50, 10 gals. \$9.50.

Rotenone Dust. Efficient control of chewing insects. Non-poisonous. Highly recommended for bean beetle, cabbage worm, etc. For dusting only. 1 lb. 30c, 5 lbs. \$1.25, 25 lbs. \$5.00.

Semesan. Semesan may be applied in dust or liquid form to the seed before planting. It is harmless to seed but deadly to disease organisms which may be on the seed. 1 oz. treats 15 lbs. of seeds. Effective in controlling damping off. 2 ozs. 50c, lb. \$2.50, 5 lbs. \$11.75.

Slug Shot, Hammond's. Destroys insects injurious to house and garden plants, vegetables and fruit of all kinds. Directions for use on each package. 1 lb. 25c, 5-lb. pkg. \$1.00.

Snarol. For cutworms, snails, etc. Broadcast on the ground under the plants. 1½ lbs. 35c, 4 lbs. 85c, 15 lbs. \$3.00, 50 lbs. \$8.00.

***Soap Spray, "Imp."** It contains vegetable poisons, harmless to plants, but peculiarly effective against red spider on fruits, etc., the Rhododendron fly. Qt. \$1.00, gal. \$3.00, 5 gals. \$12.00, 10 gals. \$20.00.

Soap, Fish Oil. Is a most effective preparation for destroying San Jose scale, plant lice and all sucking insects. 1-lb. box 35c, 5-lb. box \$1.40.

Sulphur Flour. Useful for fumigating. Lb. 10c, 5 lbs. 40c, 10 lbs. 75c, 25 lbs. \$1.75, 100 lbs. \$6.50.

***Thrip Juice No. 2.** Very effective in destroying thrips on Grapes, aphids, red spider, mealy bug, and other sucking insects. Qt. \$1.25, gal. \$4.80.

Tobacco Dust. For aphids, etc., on the foliage and around the roots. Lb. 15c; 5 lbs. 50c, 25 lbs. \$2.00, 50 lbs. \$3.50, 100 lbs. \$6.00.

Tobacco Stems. Small quantities. Lb. 5c, \$1.00 per bbl. Large bales or cases, lb. 4c.

***Vermine.** A soil sterilizer and germicide for all soil vermin, such as cut, eel, wire and grub worms, slugs, root lice, maggots and ants. Used in the greenhouse, garden and field, and protects your crops and lawns against the ravages under soil. Pt. 75c, qt. \$1.25, gal. \$3.50.

Volck. One of the most powerful insecticides known for the control of red spider and scale. Volck is non-poisonous. Must not be used in connection with lime or sulphur. Qt. \$1.00, gal. \$3.00.

***Wilson's O. K. Plant Spray.** A contact spray for Roses, Chrysanthemums, Carnations, Grape vines (when dormant), etc. Qt. \$1.00, gal. \$3.00, 5 gals. \$12.00, 10 gals. \$22.00, 25 gals. \$50.00, 50-gal. bbl. \$90.00.

***Weed Exterminator, "Herbicide."** Is a powerful chemical solution for destroying weeds and vegetation of all kinds on roadways, paths, gutters and tennis courts.
 1-qt. can\$0.50 5-gal. can\$ 6.00
 1-gal. can 1.50 10-gal. can 10.00

Hammond's Liquid Slug Shot

A safe, economical, combined pyrethrum and rotenone spray. Kills all insects, and especially effective against mealy bug, and also fungous diseases. One ounce makes six gallons. 1 oz. 35c, 6 ozs. \$1.00, 16 ozs. \$2.25, qt. \$4.00, gal. \$12.00.



Red Arrow is a contact insecticide particularly adapted for flowers, fruits and vegetables. It kills both chewing and sucking insects and is especially recommended for the control of Mexican bean beetle and *Gladolus* thrip, as well as aphids, leaf hoppers, etc. A very important thing about Red Arrow is that it is economical, combining the highest killing power with the greatest coverage. Oz. 35c, 4 ozs. \$1.00, pt. \$2.50, qt. \$4.00, gal. \$12.00.

McCloud's Red-Squill Rat Exterminator. Kills rats. A few drops on bread. Safe to use anywhere. Not a poison. Large size makes 100 baits, price \$1.00. Small size makes 50 baits, price 60c.

AGRICULTURAL CHEMICALS and FERTILIZERS

Grey's 9-6-6 Plant Food for Lawns, etc.



Grey's Plant Food contains the necessary ingredients to feed your lawns, flowers, trees and shrubs.

Grey's Plant Food is a "complete" fertilizer, odorless, easy to handle and free of weed seeds.

Grey's Plant Food meets all the plant food requirements to promote a rich, luxuriant growth and an abundance of foliage and bloom.

Grey's Plant Food is adapted to lawns, golf courses and gardens. Also may be used on trees and shrubs with splendid results.

Directions for use in every package.

10 lbs.	\$0.75	50 lbs.	\$2.50
25 lbs.	1.50	100 lbs.	4.00
Ton.....			\$70.00

ALL PRICES SUBJECT TO CHANGE WITHOUT NOTICE

A. A. Superphosphate. 16 per cent soluble and available phosphoric acid. 100 lbs., \$1.50; per ton, \$25.00.

Ashes, Unleached Hardwood. High in potash. In bags, per 100 lbs., \$3.00; per ton, \$50.00.

Bowker's Market Garden Fertilizer, 4-8-4. For vegetables and small fruits where a good balance of the three plant foods is desired. A good, high-grade fertilizer to use where moderate applications of manure are occasionally made. 100 lbs., \$2.50; per ton \$42.00.

Blood Tannage. 14 per cent. \$5.00 per 100 lbs.

Bon Arbor. Immediately soluble in water. A complete plant food, containing nitrogen, potash and phosphoric acid in sufficient quantities. 1-lb. pkg. making 30 gals., 75c; 5 lbs., \$3.00.

Bone, Coarse or Cracked. Ground coarse for Grape borders or poultry. 100 lbs. \$4.00.

Calcium Chloride. Dust layer and surface binder. 100 lbs. will cover about 50 square yards. 100 lbs. \$4.00.

Castor Pomace. Is an organic ammoniate used on lawns and golf courses. 100 lbs. \$2.50.

Clay's Fertilizers. This valuable imported manure is especially recommended to all who grow either fruit, flowers or vegetables and wish to bring them to the highest perfection. 14 lbs. \$2.50, 28 lbs. \$4.00, 56 lbs. \$7.50, 112 lbs. \$14.00.

Charcoal. Coarse and fine. 10 lbs. 50c, per 100 lbs. \$4.00.

Cottonseed Meal. Is being widely used by gardeners, florists, nurserymen, as well as on golf courses and vegetable gardens. 100 lbs., \$3.50.

Humus. Finely ground and screened for renovating lawns, golf courses, flower beds, etc. Improves potting soil. 100 lbs., \$2.00.

Lime, Agricultural. An unusually pure calcium lime, especially prepared for use on the soil. Shipped in the form of a dry powder in bags of 100 lbs. each. Per 100 lbs. \$1.00; ton, \$16.00.

Mowrah Meal. Used extensively for killing earthworms on lawns and putting greens. 100 lbs. \$4.00.

Muriate of Potash. 50 per cent actual potash. 100 lbs., \$4.00.

Nitrate of Soda (Reground). 10 lbs., 75c; 25 lbs., \$1.50; 50 lbs., \$2.25; 100 lbs., \$3.50.

Pulverized Sheep and Goat Manure. A. A. C. brand. This brand has no objectionable odor. It is pure natural manure and the most nutritious food for plants, lawns, wherever a strong, luxuriant growth is needed.

5 lbs.	\$0.40	50 lbs.	\$ 2.00
10 lbs.60	100 lbs.	3.25
25 lbs.	1.25	Ton	55.00

Pulverized Poultry Manure. 100 lbs., \$3.50.

Salt. Top-dressing for lawns and Asparagus beds. Price per bag about 140 lbs. \$2.50.

Soot, Imported Scotch. Prevents mildew when mixed with sulphur at the rate of one-third sulphur and two-thirds soot; also a good fertilizer. 10 lbs. \$1.00, 100 lbs. \$7.00.

Sulphate of Ammonia. 20.56 per cent nitrogen. \$3.50 per 100 lbs.

Shredded Cattle Manure. 100 lbs. \$3.00.

Special Ground Bone. An excellent material for use where gradual but long continued effects of nitrogen and phosphoric acid are desired, as under and around perennials, trees and shrubs, or before seeding to grass. 5 lbs., 35c; 10 lbs., 60c; 25 lbs., \$1.00; 50 lbs., \$1.75; 100 lbs., \$3.00; ton, \$50.00.

Stockbridge Early Crop Manure, 5-8-7. A fertilizer especially adapted to soils lacking nitrogen and for use with all root and other vegetable crops. 100 lbs., \$2.75.

Stockbridge Potato and Vegetable Manure, 4-8-10. Well adapted to poor or lightly manured soils—especially for Potatoes, Beets, and for many foliage crops, except Cabbage, which requires considerably more available phosphoric acid. 100 lbs., \$2.75; per ton, \$45.00.

Adco

For making artificial manure. Dry leaves mixed with Adco and kept moist, turn into excellent manure. So do flower stalks, cuttings, pea vines and almost any other kind of non-woody vegetable waste. Adco is a powder which, mixed with vegetable matter and kept moist, turns the latter into real manure, but without odor, flies, etc.

In 25-lb. bags (Making 1/2 ton of manure) Each \$2.25
In 150-lb. bags (Making 3 tons of manure) ... Each \$10.50

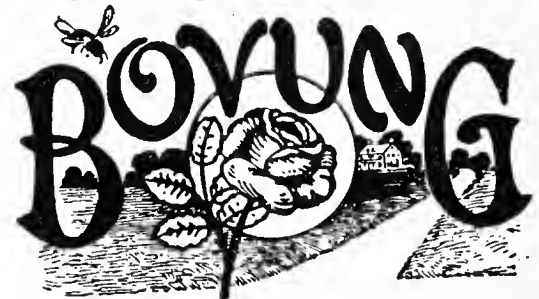

A Natural Organic Fertilizer

Dried cow manure (dehydrated) combining the chemical values of fertilizer with the organic values of manure. It is the natural plant food for lawns, flowers, etc.; is absolutely free from live weed seeds, and is clean, odorless, and convenient to handle. It can be applied without fear of burning or harmful results, and it contains all the essentials necessary for soil improvement and vigorous plant growth. Price \$1.50 per bag of 50 lbs.

Plantabbs

Odorless plant food tablets. 25c, 50c, and \$1.00 per pkg.

Naptoside

The New Fumigant-Insecticide Kills Thrips, Millepedes, Sow Bugs, and other insects of the soil. Also used to prevent fungous diseases. Apply one pound to 100 sq. ft. 25 lbs., \$4.00; 50 lbs., \$6.00; 100 lbs., \$11.00.

Tri-O-Gen-Rose Garden Spray

Combined spray treatment, fungicide, insecticide, and plant stimulant. Combined as a Kit. Harmless to foliage or blooms. Small Kit, \$1.50; Medium Kit, \$4.00; Large Kit (makes 32 gallons), \$6.00.

Peat, Leaf Mold, etc.

Peat Moss (Imported). Coarse and fine, \$3.50 per bale. Trial bale, \$1.25 each.

Silver Sand. For mixing with potting soil, etc. Pk. 75c. bu. \$2.00.

Leaf Mold. Best quality. Bag \$3.50.

Moss, Live Sphagnum. Bu. \$1.50, bag \$3.50.

Moss, Dry Sphagnum. Bag \$1.50. Small bale \$6.50, large bale \$10.00.

Orchid Peat, or Fern Root. Best selected. Hand picked. Bag \$3.00.

INDEX

- Abutilon5, 71
 Acacia 5
 Acanthus 5
 Achillea5, 72
 Achimenes 5
 Achyrantes71
 Acidanthera 70
 Aconitum.....5, 72
 Acroclinium 5
 Actinidia 80
 Adiantum 18
 Adlumia 5
 Adonis 5
 Aethionema 4
 Agatheia 5
 Ageratum5, 71
 Agrostemma 6
 Ajuga 72
 Akebia 80
 Alfalfa 65
 Almond 77
 Alonsoa 6
 Alstroemeria 6
 Alternanthera 71
 Althea 77
 Alyssum...4, 6, 71, 72
 Amaranthus 6
 Amaryllis 6
 Ambrosia 6
 Ampelopsis6, 80
 Amygdalus 77
 Anchusa6, 72
 Andromeda 83
 Anemone...4, 6, 72
 Anthemis6, 72
 Anthericum 6
 Antirrhinum...7, 71
 Inside Front Cover
 Apples 84
 Aquilegia 4, 7, 72
 Arabis7, 72
 Aralia7, 77
 Arborvitae80, 81
 Arctotis 7
 Inside Front Cover
 Arenaria 4
 Argemone 8
 Aristolochia 80
 Armeria8, 72
 Artichoke... 43, 62
 Asclepias8, 72
 Ash 79
 Asparagus 8
 Asparagus (Vegetable)...41, 43, 62
 Asperula 8
 Asphodelus 8
 Asters...1, 8-10, 71, 72
 Aubrietia4, 10
 Azalea 77

 Babysbreath .. 20, 73
 Balloon Vine 10
 Balsam10, 22
 Baptisia 10, 72
 Barberry77, 80
 Barley 66
 Bartonia 10
 Beans...41, 43, 44, 66
 Beans, Flowering. 10
 Beautybush 77
 Bedding Plants... 71
 Beech 79
 Beets41, 45, 66
 Begonias
 ...1, 10, 11, 70, 71
 Bellflower .1, 4, 12, 72
 Bellis 11
 Berberis 77
 Bignonia 80
 Birch 79
 Bird Seeds..... 65
 Blackberries 85
 Blanketflower...19, 73
 Bleeding Heart... 73
 Bocconia 11
 Boltonia11, 72

 Borecole 50
 Brachycome 11
 Bridal Wreath... 18
 Broccoli 44
 Broom 19
 Browallia 11
 Brussels Sprouts
 45, 62
 Buckwheat 66
 Buddleia 77
 Bulbs67-70
 Buphthalmum 11

 Cabbage ...41, 46, 62
 Cacalia 11
 Cactus 11
 Caladium 71
 Calandrinia 4
 Calceolaria1, 11
 Calendula11, 71
 Calliopsis 12
 Callirhoe 12
 Campanula 1, 4, 12, 72
 Candytuft 4, 13, 21, 74
 Cannas 13, 70, 71
 Canterbury Bells
 1, 4, 12, 72
 Caragana 78
 Cardinal Climber. 22
 Cardoon 47
 Carnation 16, 17
 Carrot41, 47
 Castor-oil Beans...
 32, 71
 Catalpa 79
 Catchfly 35
 Cauliflower.41, 47, 62
 Celastrus 80
 Celery41, 48, 62
 Celosia 13
 Celsia 13
 Centaurea...13, 71, 72
 Cerastium13, 72
 Cheiranthus...14, 73
 Chelone14, 72
 Cherries 84
 Chervil 47
 Chicory 47
 Chinese Cabbage. 41
 Chionanthus 77
 Chives50, 62
 Chorizanthe 14
 Christmas Rose .. 73
 Chrysanthemums
 14, 71, 73
 Cineraria 14
 Clarkia 14
 Clematis14, 80
 Cleome 14
 Clivanthus 14
 Climbing Plants.. 80
 Clover36, 65
 Cobaea15, 71
 Cockscomb 13
 Colchicum 15
 Coleus15, 71
 Collards 50
 Collinsia 15
 Collections of Seeds 40
 Columbine7, 72
 Commelina 15
 Convolvulus 67
 Convallaria 67
 Convulvulus 15
 Coralberry 77
 Coreopsis12, 73
 Corn, Field..... 66
 Corn, Kaffir..... 66
 Corn, Sweet 41, 48, 49
 Corn Salad..... 50
 Cornus77, 79
 Cosmos2, 15, 71
 Cotoneaster 77
 Cress 50
 Cucumber 49
 Cuphea 15
 Cyclamen 1, 15
 Cydonia 78

 Cynoglossum 15
 Cyperus 15
 Cypress, Japan ... 82
 Dahlias 1, 15, 70
 Daisies
 11, 14, 18, 19, 71, 75
 Dandelion 50
 Daphne77, 83
 Datura 16
 Delphinium 2, 16, 73
 Deutzia 77
 Dianthus 4, 16, 17, 73
 Diascia 17
 Dicentra 73
 Dictamnus 17, 73
 Didiscus 17
 Dielytra 73
 Digitalis 17, 73
 Dimorphotheca .. 17
 Dogwood77, 79
 Dolichos 17
 Doronicum .. 17, 73
 Dracaena 17
 Draccephalum .. 17
 Dusty Miller 13

 Echinacea 17
 Echinocystis 17
 Echinops 18, 73
 Echium 18
 Edelweiss 18
 Eggplant 50, 62
 Elm 79
 Endive 50
 English Ivy..... 80
 Erigeron 18
 Erinus 4
 Eryngium 18
 Erysimum 18
 Eschscholtzia ... 18
 Euonymus 77, 83
 Eupatorium 18
 Euphorbia 18
 Evergreen Shrubs.. 83
 Evergreen Trees
 81, 82
 Exacum 2, 18

 Farm Seeds 66
 Fennel 50, 62
 Ferns 18
 Fescue 64
 Feticus 50
 Feverfew 24, 71
 Fir 81
 Flameflower .. 37, 75
 Flower Seed Novel-
 ties for 1936 ... 1-4
 Flowering Crab .. 79
 Flowering Rasp-
 berry 78
 Foliage Plants .. 71
 Forget-me-not 25, 74
 Forsythia 77
 Four O'Clock 25
 Foxglove 17, 73
 Francoa 18
 Freesia 18
 Fringe Tree 77
 Fruit Trees 84
 Fruits, Small 85
 Fuchsia 19, 71
 Funkia 73

 Gaillardia 19, 73
 Garlic 50
 Gaura 19
 Gazania 19
 Genista 19
 Gentiana 19
 Geranium 19, 71
 Gerardia 19
 Gerbera 19
 Gesneria 19
 Geum 19
 Gilia 19
 Gilliflower 35
 Gladiolus68, 69

 Glaucum 19
 Globe Amaranth .. 19
 Globeflower .. 38, 75
 Gloxinia 19, 70
 Gnaphalium 18
 Godetia 20
 Gomphrena 19
 Gourds 2, 7
 Grapes 85
 Grass Seeds ...63-65
 Grasses, Orna-
 mental 40
 Grevillea 20
 Gumbo 53
 Gypsophila.. 4, 20, 73

 Hardy Perennial
 Plants72-75
 Hardy Rock Gar-
 den Plants 4
 Hawthorn 79
 Heather 83
 Hedera 80
 Hedge Plants.... 80
 Helenium 20, 73
 Helianthemum ... 20
 Helianthus ... 20, 73
 Helichrysum 20
 Heliophila 20
 Heliopsis 73
 Heliotrope 21, 71
 Helleborus 73
 Hemerocallis ... 74
 Hemlock 80, 81
 Herbs 62
 Hesperis 21
 Heuchera 21, 74
 Hibiscus... 21, 74, 77
 Hollyhock 21, 74
 Honesty 21
 Honeysuckle .. 77, 80
 Hop Vine 80
 Horseradish ...50, 62
 Humulus 21
 Hunnemannia ... 21
 Hyacinthus 70
 Hydrangea 77

 Iberis 21, 74
 Ice Plant 22
 Impatiens 22
 Incarvillea 22
 Inula 22
 Ipomoea 22
 Iris 22, 74
 Ivy 80
 Japanese Quince.. 78
 Jerusalem Cherry 35
 Jetbead 77
 Judas-Tree 79
 Juniper 81

 Kaffir Corn 66
 Kale 50
 Kalanchoe 2
 Kochia 22
 Kohlrabi 50
 Kolkwitzia 77
 Kudzu Vine 22

 Lantana 22, 71
 Larkspur 16, 73
 Lathyrus 22, 74
 Lavandula.. 4, 22, 74
 Lavatera 22
 Lawn Grass...63, 65
 Leek 51
 Leptosyne 23
 Lettuce41, 51, 62
 Leucothoe 83
 Liatris 23, 74
 Lilac 78, 80
 Lilies .. 23, 67, 73, 74
 Lily-of-the-Valley
 67, 74
 Linaria 23
 Linden 79
 Linum ... 4, 23, 71
 Lobelia ... 23, 71, 74

 Loniceria77, 80
 Lophospermum ... 23
 Love-in-a-Mist ... 27
 Lunaria 21
 Lupinus 23
 Lychnis ... 4, 24, 74
 Lycium 80
 Lythrum 24, 74
 Magnolia 79
 Maidenhair-Tree .. 79
 Mallow 24, 74
 Malope 24
 Malva 24
 Mangel-Wurzel 45, 66
 Maple 79
 Marigold .. 2, 24, 71
 Matthiola 24
 Matricaria 24
 Maurandia 24
 Meconopsis 24
 Melons 41, 52
 Mesembryanthemum
 2, 24
 Mignonette. 24, 25, 71
 Millet 66
 Mimosa 25
 Mimulus 25
 Mina 25
 Mirabilis 25
 Mixtures, Hay ... 65
 Mixtures, Pasture. 65
 Momordica 25
 Monarda 74
 Montbretias 70
 Morning-glory ... 22
 Mountain-Ash .. 79
 Mountain-Laurel. 83
 Mulberry 79
 Musa 25
 Mushrooms 53
 Muskmelon .. 41, 52
 Musk Plant 25
 Mustard 53
 Myosotis 25, 74
 Myrsiphyllum ... 35
 Nasturtium 2, 25, 26
 Nemesia 26
 Nemophila 26
 Nepeta 4, 74
 Nicotiana 27, 71
 Nierembergia ... 27
 Nigella 27
 Nolana 27
 Nycterinia 27
 Oak 79
 Oat Grass 64
 Oats 66
 Oenothera ... 27, 74
 Okra 53
 Onions 42, 54
 Onion Sets 54
 Orchard Grass ... 64
 Oxalis 27
 Pachysandra ... 83
 Pansies
 2, 27, 28, 38, 71, 75
 Papaver 30, 74
 Parsley 42, 54
 Parsnips 56
 Passiflora 28
 Peaches 84
 Pears 84
 Peas. 22, 42, 55, 56, 74
 Peas, Field 66
 Pea-tree, Siberian 78
 Pentstemon .. 28, 74
 Peonies 74, 75
 Pepper56, 62
 Pepperbush 78
 Pepper Grass ... 50
 Perennials 72-75
 Perennial Rye
 Grass 64
 Perilla 28
 Petunias 2, 28, 29, 71
 Phacelia 29

INDEX—Continued

- Philadelphus 78
 Phlox 29, 71, 75
 Phormium 29
 Physalis 29
 Physostegia .. 29, 75
 Pine 82
 Pinks 16, 73
 Platycodon .. 29, 75
 Plums 84
 Polemonium 30
 Polygonum 80
 Poplar 79
 Poppies 11, 18,
 30, 33, 74
 Portulaca 30
 Potatoes 57
 Potentilla 30
 Primroses
 27, 31, 32, 74, 75
 Primula .. 3, 31, 32, 75
 Privet 78, 80
 Pumpkin 57
 Pyrethum 32, 75

 Quince, Japanese. 78
 Quinces 84

 Radish 57
 Ranunculus 32
 Rape 65, 66
 Raspberries 85
 Raspberry, Flower-
 ing 78
 Red Top 64
 Reseda 24-25
 Retinospora 82
 Rhodanthe 32
 Rhode Island Bent 65
 Rhododendron... 83
 Rhodotypos 77
 Rhubarb 58, 62
 Ricinus ... 32, 33, 71
 Rock Garden Plants 4
 Romneya 33
 Roots and Plants.. 62
 Rose of Sharon .. 77
 Roses 76
 Rudbeckia 33, 75
 Rutabaga 61
 Rye 66
 Rye Grass 64

 Saintpaulia 33
 Salpiglossis .. 33, 71
 Salsify 58
 Salvia... 3, 33, 34, 71
 Sanvitalia 34
 Saponaria 34, 75
 Satin Flower 20
 Saxifraga 4
 Scabiosa 34
 Schizanthus ... 3, 34
 Schizopetalon ... 34
 Sea-lavender .. 35, 75
 Seaside Bent 65
 Sedum 4, 34, 75
 Seeds for Wild
 Gardens 40
 Sensitiveplant ... 25
 Shamrock 34
 Shrubs 77, 78
 Shrubs, Ever-
 green 83
 Siberian Pea-tree 78
 Sidalcea 34
 Silene 4, 35
 Silver Lace Vine 80
 Small Fruits 85
 Smilax 35
 Smoke Bush 78
 Snapdragon ... In-
 side Front Cover, 71
 Snowberry 78
 Soja Beans 66
 Solanum 35
 Sorghum 66
 Sorrel 58
 Specialties in
 Flower Seed .. 1-4

 Specialties in Veg-
 etable Seed 41
 Spinach... 42, 53, 58
 Spiraea .. 75, 78, 80
 Spruce 80, 82
 Squash 42, 59
 Statice 35, 75
 Stephanandra .. 78
 Stevia 35
 Stocks 24, 35, 36
 Stokesia 36, 75
 Strawberries 85
 Streptocarpus ... 36
 Sudan Grass 66
 Sunflower .. 20, 66, 73
 Swainsonia 36
 Sweet Clover 36
 Sweet Lavender .. 22
 Sweet Peas... 3, 36, 37
 Sweet Potatoes .. 57
 Sweet Vernal ... 64
 Sweet William... 37, 73
 Symphoricarpos 77, 78
 Syringa 78
 Tarragon Plants .. 62
 Thalictrum 37
 Thunbergia 37
 Timothy 64
 Tithonia 37
 Tobacco 62
 Tomato .. 42, 60, 61, 62
 Torenia 37, 71
 Trees, Deciduous.. 79
 Evergreen .. 81, 82
 Fruit 84
 Tritoma 37, 75
 Trollius 38, 75
 Tropaeolum 38
 Tuberosa 70
 Tunica 4
 Turnip 61
 Ursinia 38
 Valerian 38
 Vegetable Oyster. 58
 Vegetable Roots
 and Plants 62
 Vegetable Seed
 Specialties
 41, 42, 43, 61
 Velvet Bent..... 65
 Venidium 38
 Verbascum 38
 Verbena ... 3, 38, 71
 Veronica ... 4, 38, 75
 Vetches 66
 Viburnum 78
 Vinca.. 38, 71, 75, 83
 Vines 80
 Viola 3, 38, 75
 Virginian Stock.. 39
 Viscaria 39
 Wallflower ... 39, 71
 Watermelon ... 41, 52
 Weigela 78
 Wheat 66
 Wild Garden Flow-
 er Seeds 40
 Willow 79
 Wisteria 80
 Wood Meadow
 Grass 64
 Xeranthemum ... 39
 Yew 82
 Yucca 39, 83
 Zea 39
 Zinnia 3, 39, 71

SUNDRIES
 A. A. Super Phos-
 phate 98
 Agricultural Chem-
 icals and Fertiliz-
 ers 98
 Adco 98
 Adjusto Plant
 Supports 90
 Antipestick 90

 Ant Trap 97
 Aphine 97
 Arsenate of Lead 97
 Ashes, Hardwood 98
 Asparagus Buncher 86
 Asparagus Knife 86
 Axes 86
 Bamboo Poles ... 86
 Bands, Rubber .. 86
 Barrels 90
 Barrows 86
 Barrow Leaf
 Rack 86, 90
 Bars, Crow 86
 Baskets 86
 Bovung 98
 Bill Hooks 86
 Black Leaf 40... 97
 Blood Tankage .. 98
 Bon Arbor..... 98
 Bone 98
 Books 101
 Bordeaux Mixture. 97
 Bowker's Fertilizer 98
 Boxes, Corrugated 86
 Boxes, Flower ... 86
 Bulb and Seed
 Pans 87
 Burlap 87
 Burning Brands .. 87
 Bush Hooks 87
 Bye, Bye, Black-
 bird 97
 Calcium Chloride . 98
 Carbola 97
 Carnation Supports 87
 Castor Pomace .. 98
 Cattle Manure ... 98
 Celery Wrappers.. 87
 Charcoal 98
 Clay's Fertilizers.. 98
 Copper, Ammoniated
 Solution 97
 Corn Planter 96
 Cotton Wadding.. 87
 Cottonseed Meal.. 98
 Creosote 97
 Cultivator
 87, 92, 93, 96
 Cyanogas 97
 Dibbles 87
 Dusters... 90, 91, 92
 Edging Knives ... 87
 Electric Tape ... 87
 Farm and Garden
 Tools and Imple-
 ments 96
 Farm, Garden and
 Lawn Requisites,
 Tools, etc. ... 86-98
 Fern Roots 98
 Fertilizers 98
 Fertilizer Distrib-
 utor 96
 Floral Tools 87
 Flower Pots, Sauc-
 ers, etc. 87
 Flower Pot Hang-
 ers 87
 Flower Vases.... 87
 Forks, Miscellan-
 eous 87, 89
 Formacide 97
 Fungicides 97
 Fungtrogen 97
 Garden Books .. 101
 Garden Grower .. 93
 Garden Lines ... 87
 Garden Reels ... 87
 Garden Requisites
 86, 98
 Gardener's Gloves. 87
 Glass Cutter 87
 Glaziers' Points.. 87
 Gloves 87
 Goat Manure 98

 Grafting Knife ... 87
 Grafting Wax... 87
 Grape Dust 97
 Grass Catchers... 94
 Grass Hooks 87
 Grey's Plant Food 98
 Grindstones 87
 Ground Bone 98
 Hammers 87
 Hand Cart, Box,
 etc. 90
 Hand Garden
 Tools 92, 93
 Handles 87
 Harrows 96
 Hatchets 87
 Hay Forks 87
 Hedge Shears ... 89
 Herbicide 97
 Hoes .. 87, 88, 92, 96
 Hose, Rubber 88
 Hose Clamps 88
 Hose Connections. 88
 Hose Couplings.. 88
 Hose Menders ... 88
 Hose Nozzles ... 88
 Hose Reducers ... 88
 Hose Reels 88
 Hose Washers ... 88
 Hotbed Mats 88
 Hotbed Sash 89
 Humus 98
 Insecticides and
 Fungicides.. 90, 97
 Knives, Budding.. 88
 Labels 88
 Lawn Mowers,
 Power 93
 Lawn Mowers,
 Hand 94
 Lawn Mower Serv-
 ice Department . 94
 Lawn Rollers ... 95
 Lawn Sand 98
 Leaf Mold 98
 Leaf Rack 90
 Lemon Oil 97
 Lime 97, 98
 Lime-Sulphur Solu-
 tion 97
 Manure 98
 Manure Forks .. 87
 Mats, Hotbed 88
 Mattocks 88
 Melon Nets 88
 Mole Traps 88
 Moss 98
 Mowrah Meal ... 98
 Muriate of Potash 98
 Naptoside 98
 Nico-Fume
 Products 97
 Nitrate of Soda .. 98
 Oilers 88
 Oil 88
 Orchid Peat 98
 Pails 88
 Pans, Bulb and
 Seed 87
 Paper 88
 Peat 98
 Pencils 88
 Picks 88
 Plant Food 98
 Plant Sprinklers. 89
 Plant Tubs... 88, 89
 Plantabbs 98
 Plows ... 92, 93, 96
 Poles 89
 Pomo-Green with
 Nicotine 97
 Post Hole Digger 89
 Potato Hoe 96
 Poultry Manure.. 98
 Pruners 89
 Pulverized Manure 98
 Pumps 89, 91

 Putty Bulb 89
 Putty 89
 Pyrox 97

 Raffia 89
 Rakes 88, 89
 Red Arrow Insect
 Spray 97
 Richard's X L All 97
 Rollers 95
 Rope 89
 Rotenone Dust ... 97

 Salt 98
 Sand, Silver 89
 Sash, Hotbed 98
 Saws 89
 Scalecide 97
 Scissors 89
 Scoops 89
 Scrapers 96
 Scythes 89
 Scythe Stones... 89
 Seed Drill 92
 Seed Pans 87
 Seed Sower 89
 Seeders 92
 Semesan 97
 Shears 89
 Sheep Manure... 98
 Shelton's Baskets 86
 Shovels 89
 Sickles 87
 Silkaline 89
 Silver Sand 98
 Slug Shot 97
 Snarol 97
 Soap Spray 97
 Soap, Fish Oil .. 97
 Sod Lifter 89
 Soot 98
 Spades 89
 Spading Forks ... 87
 Sprayers and
 Dusters .. 90, 91, 92
 Sprinklers 95
 Stake Fasteners . 89
 Stakes, Garden 89, 90
 Sticks, Match ... 90
 Stockbridge
 Manure 98
 Stone Boats 96
 Styptic 90
 Sulphate of Am-
 monia 98
 Sulphur Flour ... 97
 Superphosphate
 A. A. 98
 Tamper 90
 Thermometers ... 90
 Thrip Juice 97
 Tinfoil 90
 Tobacco Dust... 97
 Tobacco Stems ... 97
 Tree Scrapers ... 90
 Trellises 90
 Tri-O-Gen 98
 Trowels 90
 Truck 90
 Trunnions 90
 Tubs, Plant.. 88, 89
 Twine 90
 Vermine 97
 Volck 97
 Watering Pots ... 90
 Wayward Vine
 Guide and
 Support 87
 Wedges 90
 Weeders 90, 96
 Weed Exterminator
 97
 Weed Puller 90
 Wheelbarrows ... 86
 Wheel Hoe 92
 Wilson's O. K.
 Plant Spray ... 97
 Wire 90
 Wrenches 90



Practical Books for the Home Gardener

GARDEN MAINTENANCE. By H. Stuart Ortloff and Henry B. Raymore. Illustrated with photographs and drawings. Frontispiece in color. \$2.50.

THE BOOK OF BULBS. By F. F. Rockwell. 187 illustrations, 264 pages. \$2.00.

THE GARDENER. By L. H. Bailey. 116 illustrations, 260 pages. \$2.00.

THE CULTIVATED CONIFERS. By Dr. L. H. Bailey, 404 pages, 162 illustrations. \$7.50.

FERTILIZERS. By E. B. Voorhees. Revised by S. B. Haskell. 29 illustrations, 310 pages. \$2.50.

INFORMAL GARDENS. By H. Stuart Ortloff. 104 pages, 17 illustrations. \$1.60.

THE HOME GARDEN HANDBOOKS. By F. F. Rockwell. \$1.25 per volume. The titles now published are: Rock Gardens; Irises; Dahlias; Gladiolus; Roses; Peonies; Evergreens; Shrubs; Lawns.

AROUND THE YEAR IN THE GARDEN. By F. F. Rockwell. 88 illustrations, 350 pages. \$2.50.

ANNUALS IN THE GARDEN. By H. Stuart Ortloff, L. A. Cloth 12 mo. \$1.25.

PERENNIAL GARDENS. By H. Stuart Ortloff. 92 pages. 18 illustrations. \$1.25.

GARDEN POOLS—LARGE AND SMALL. By Ransey and Lawrence. 41 illustrations, 122 pages. \$2.50.

THE GARDEN CLUB MANUAL. By Edith R. Fisher. \$2.00.

THE HOME VEGETABLE GARDEN. By E. M. Freeman. 8 illustrations, 214 pages. \$1.75.

GARDEN FLOWERS IN COLOR. A cyclopedia of flower pictures. 320 pages, 400 photographs in color. \$3.75.



Important to Customers

ORDER EARLY.—We would suggest that customers send us their orders as soon as possible after receiving this catalog, and thus avoid the rush of the planting season. It frequently happens that some articles are not in stock when orders are received. In such cases we forward such as are ready, and the balance as soon as possible.

STOCK SEED.—A large part of our seeds are grown for us on contract by special growers, from our own stock, and in locations best suited for their development. Others are secured from strictly reliable sources, and constant effort is made to secure only the best.

ADDRESS, ETC.—Give name of your **Post Office, County and State**, sign your name plainly; also specify means of conveyance preferred—whether by parcel post, express or freight.

SHIPPING.—We deliver free to Express, Railroad or Boat. All goods travel at the buyer's risk, our responsibility ceases when we take the carrier's receipt. If goods are damaged so sign for them and enter claim with the carrier at once. Free delivery, see page 62.

BAGS AND PACKING.—No charge is made for boxes or packing on anything, except **Flower Pots, Nursery Stock and Hotbed Sash**, and this at cost only. **Cloth Bags** are charged for at cost and if returned in good condition, charges prepaid, will be credited at price charged.

REMITTANCES.—May be made by Express Money Order, P. O. Money Order or Bank Draft; if stamps or cash, send in a Registered Letter. Parties having no account with us, who order goods without remittance, must furnish satisfactory references. Boston preferred.

Due to the unsettled market conditions, we cannot guarantee the prices published in this catalog. Each sale will be subject to current prices and also to any Federal or State Sales Tax in effect. Advances will not be made until necessary.

TERMS ARE NET CASH.—All bills on which short credits are allowed are due on the first of the month succeeding the date of the purchase.

WARRANTY.—We give no warranty, expressed or implied, as to quality, description, productiveness, or any other matter of any Seeds, Bulbs or Plants we send out, and will not be in any way responsible for the crop. If the purchaser does not accept the goods on these terms, they must at once be returned.

PARCEL POST RATES

Packages must not exceed 100 inches in length and girth combined. Seventy pounds is the limit of weight.

Wght. in Lbs.	ZONES							
	Local	1st - 2nd	3rd	4th	5th	6th	7th	8th
		Up to 150 miles	150 to 300 miles	300 to 600 miles	600 to 1000 miles	1000 to 1400 miles	1400 to 1800 miles	Over 1800 miles
1....	\$0.07	\$0.08	\$0.09	\$0.10	\$0.11	\$0.12	\$0.14	\$0.15
2....	.08	.10	.11	.14	.17	.19	.23	.26
3....	.08	.11	.13	.17	.22	.26	.32	.37
4....	.09	.12	.15	.21	.27	.33	.41	.48
5....	.09	.13	.17	.24	.33	.40	.50	.59
6....	.10	.14	.19	.28	.38	.47	.59	.70
7....	.10	.15	.21	.31	.43	.54	.68	.81
8....	.11	.16	.23	.35	.49	.61	.77	.92
9....	.11	.17	.25	.38	.54	.68	.86	1.03
10....	.12	.18	.27	.42	.59	.75	.95	1.14
11....	.12	.19	.29	.45	.64	.82	1.04	1.25
12....	.13	.21	.31	.49	.70	.89	1.13	1.36

Postage on seeds, bulbs, plants and roots of 8 ounces or less to all zones, is 1c for each 2 ounces.

Postage on general merchandise of 8 ounces or less, to all zones, is 1½c for each 2 ounces.

THOMAS J. GREY COMPANY

THE SEEDSMEN

16 SOUTH MARKET STREET

BOSTON, MASS.

TELEPHONE: CAPITOL 7476-7477

ROBERT E. MONTGOMERY, President

FRANCIS R. CONBOY, Secretary

JOHN P. A. GUERINEAU, Treasurer



**SEEDS
BULBS
and
PLANTS**

**AGRICULTURAL
IMPLEMENTS**

for
1936

*Yellow
Supreme
Marigold*

(See page 2)

THOMAS J. GREY COMPANY

The Seedsmen

16 South Market St., BOSTON, MASSACHUSETTS
